

HANDSETS (AMPLIFIER)

G6, G7, G8, AND G13 TYPES

IDENTIFICATION, CONNECTIONS, AND MAINTENANCE

1. GENERAL

1.01 This section is reissued to:

- Add connections for G13A and G13B handsets to TOUCH-TONE® coin collector/telephones.
- Delete 3.02.
- Provide additional information on connections to rotary dial sets (3.01).
- Add information formerly contained in Section 501-211-400 which is hereby canceled.

Changes or additions in the body of tables is indicated by shaded areas.

2. IDENTIFICATION

2.01 These amplifier-type handsets are available as replacement handsets for use by persons with impaired hearing (G6- and G13-type), weak speech (G7-type), and persons in noisy locations (G8-type). Table A lists these handsets and their component parts and principal uses.

G6-Type (Impaired Hearing)

2.02 The G6-type handset is equipped with a receiver amplifier unit. The volume control potentiometer in the center of the handle adjusts the loudness setting of the receiver so that the handset may be used by persons with normal hearing as well as persons with impaired hearing.

2.03 The G6B handset (Fig. 1) has the transistorized amplifier and polarity guard units located on a printed circuit board in the receiver end of the handle. The amplifier, potentiometer assembly, and handset cord connect to a terminal board located in the transmitter cavity.

2.04 The G6AR (MD) handset (Fig. 2) consists of a printed circuit receiver board, transmitter board, and a potentiometer assembly mounted in the handle. Internal connections are made by a flexible circuit strip and plug-in connectors.

2.05 A single stage transistorized amplifier is located on the receiver board and amplifies the received signal. A polarity guard circuit, mounted on the transmitter board, assures proper polarity of the dc voltage supplied to the amplifier.

G7-Type (Weak Speech)

2.06 The G7-type handsets are equipped with a transistorized transmitter amplifier intended for use by persons with weak speech. The potentiometer in the handle controls the level of the transmitter output.

2.07 The G7B handset has the transistorized transmitter amplifier located on a printed circuit board at the receiver end of the handle. The polarity guard and one inductor are on the amplifier terminal board. The potentiometer assembly, and handset cord connect to a terminal board in the transmitter cavity. Internal connections are made by spade-tipped leads.

2.08 The G7AR (MD) handset consists of a printed circuit receiver board, transmitter board, polarity guard circuit, and a potentiometer assembly mounted in the handle. Internal connections are made by a flexible circuit strip and plug-in connectors.

G8-Type (Noisy Locations)

2.09 The G8-type handset is equipped with a transistorized receiver amplifier and a push-to-listen switch and is intended for use in noisy locations. The push-to-listen switch, when operated, decreases the transmitter output and increases the gain of the receiver amplifier.

TABLE A
G-SERIES HANDSETS

HANDSET	COLOR*	REPLACEABLE COMPONENTS					SCHEMATIC FIG. NO.	PRINCIPAL USE
		HANDLE	CORD	TMTR UNIT	TMTR CAP	RCVR CAP		
G6B	-03, -50, -51, -53, -54, -56, -58, -59, -60, -61, -62, -64	P-80G7-†	H4CT-†	T1	P-80A1-†	P-80A2-†	3	300, 500, 600, 700 1500, 1600, 1700, 2500, 2600, and 2700 series tel sets
G6AR (MD)	4						500, 600, 700, 1500, 1600, 1700, 2500, 2600, and 2700 series tel sets	
G7B	5							
G7AR (MD)	6							
G8A (MD)	7							
G8B	8							
G13A‡	-52		H4DG	T2	P-87C752		9	200-, 1200-type coin collector/ tel sets
G13B‡			H4DH					1A-, 2A-, 1C- 2C-type tel sets

*(-03) Black (-52) Gray (-56) Yellow (-60) Light Beige (-64) Turquoise
 (-50) Ivory (-53) Red (-58) White (-61) Light Gray
 (-51) Green (-54) Brown (-59) Rose Pink (-62) Aqua Blue

† Add suffix for desired color.

‡ Components are not replaceable in the field.

2.10 The G8A (MD) handset consists of the amplifier assembly mounted on the receiver board, a polarity guard and terminal board mounted on the transmitter cup, and a volume control potentiometer and push-to-listen switch mounted in the handle.

2.11 Internal connections are made by a flexible circuit strip and plug-in connectors. The cord connects to the terminal board in the transmitter cavity.

2.12 The G8B handset replaces the G8A. The transistorized amplifier and polarity guard units are mounted on a printed circuit board located in the receiver end of the handle.

G13-Type (Impaired Hearing)

2.13 The G13-type handset is similar to the G6B handset except that a slide switch replaces

the potentiometer assembly mounted in the handle and an armored cord replaces the retractile cord. The handsets furnish normal unamplified receiver output until the slide switch is moved to the center or extreme position. The center position furnishes 10db and the extreme position furnishes 20db of gain. When the button is released, a spring returns the button to normal. Coin collectors/telephones are not assembled and coded with these handsets. The handsets must be ordered separately and connected as required.

3. CONNECTIONS

3.01 To connect amplifier-type handsets to rotary dial equipped telephone sets:

- (1) Connect red and black leads to the terminals from which the red and black leads of the replaced handset were removed.

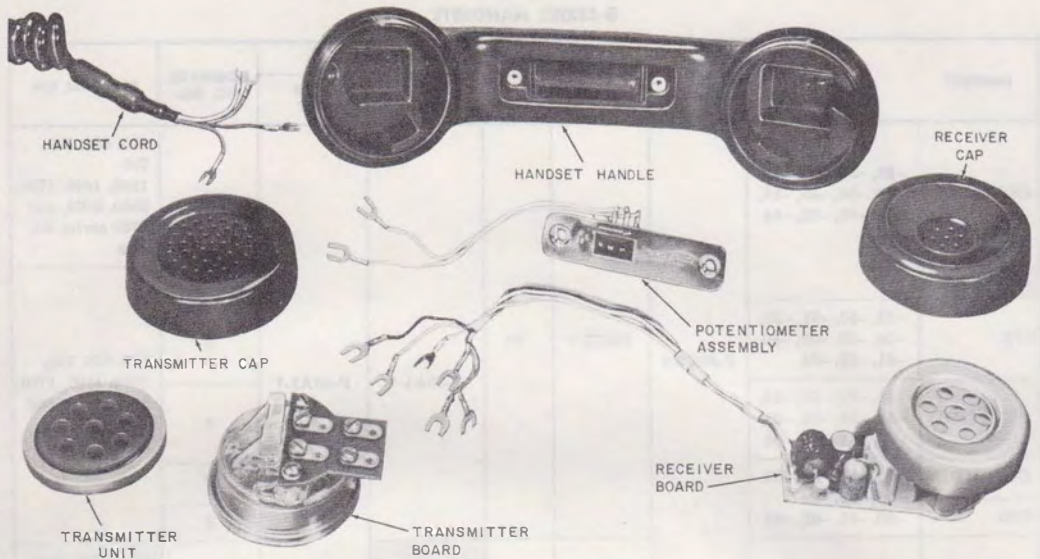

Fig. 1—G6B Handset Assembly (G7B Handset is Arranged Similarly)

(2) Connect yellow and green leads to the terminals from which the white leads were removed so that the yellow lead is electrically wired to the *R* terminal on the network and the green lead is wired to the *GN* terminal on the network.

(3) Test the handset through the full range of volume control.

3.02 When connecting G6- and G8-type handsets to telephone sets equipped with TOUCH-TONE dials, the dial must provide common switch contact arrangements which will prevent dial sidetone amplification by the handset amplifier. If the set contains a 25A3 (MD), 25B3 (MD), or 25H4 (MD) dial, install a 25W3, 25Y3, or 25P4, respectively, and connect dial and handset as shown in Table B.

3.03 When connecting G6- or G8-type handsets to 1660-series (MD) telephone sets equipped with 26B (MD) or 26D (MD) card dialers, install a 26F card dialer and connect dialer and handset as shown in Table B.

Schematics

3.04 Fig. 3 through 9 show schematic diagrams of the amplifier type handsets.

4. MAINTENANCE

4.01 Maintenance of G6-, G7-, and G8-type handsets is limited to the following:

- Replacing cracked or broken receiver and transmitter caps.
- Replacing defective transmitter units.
- Replacing defective handset cords.
- Cleaning with water-dampened cloth.

4.02 Maintenance of G13-type handsets is limited to cleaning with a water-dampened cloth, as the transmitter and receiver caps are cemented to the handset handle at the time of assembly.

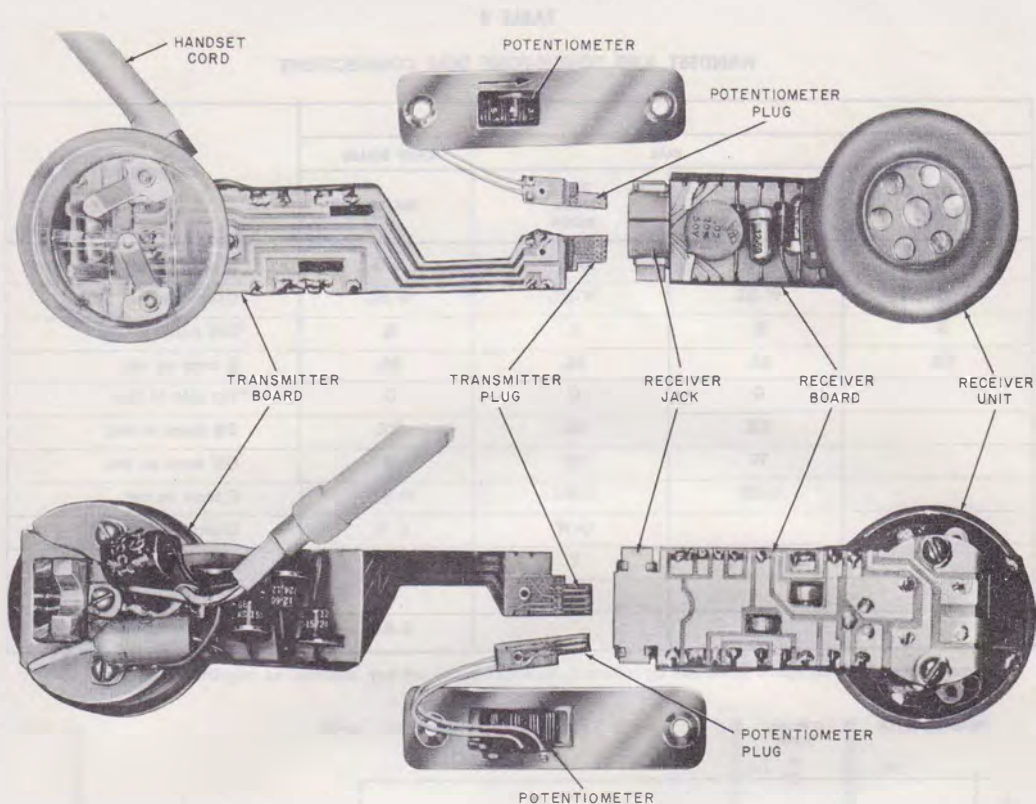

Fig. 2—G6AR Handset, Internal Assembly (G7AR and G8A are Arranged Similarly)



Do not use cleaning fluids or antirust compounds on transmitter or receiver units or other component parts of handset. Discoloration or tarnish on the silverplated contact surfaces is not objectionable and no attempt should be made to remove it.

4.03 The H4CT handset cord furnished with G6-, G7-, and G8-type handsets is not available for field use. If the original cord requires replacement, modify and install an H4CJ cord as follows:

- (1) Carefully remove outer plastic covering on two white conductors with diagonal pliers.

- (2) Tone-out and identify one white conductor. For identifying purposes, loose knots may be tied in each end of this conductor, designating it green. The other white conductor then becomes yellow.

- (3) Loop and tie or tape the excess length of white conductors to approximate length of red and black conductors.

- (4) Insert conductors in transmitter bowl carefully so as not to disrupt the printed board circuit.

TABLE B
HANDSET AND TOUCH-TONE DIAL CONNECTIONS

HANDSET	LEADS			CONNECT TO
	DIAL		CARD DIALER	
G6-, G7-, OR G8-TYPE	25P4, 25W3, 35A3A, 35E4A	25Y3, 35C3A, 35D3A	26F, 36E	
Y	R-G	R-G	R-G	R term on net.
G	W-BL	W-BL	W-BL	*Green handset lead
R	R	R	R	*Red handset lead
BK	BL	BL	BL	B term on net.
	G	G	G	*Tip side of line
	BK	BK	BK	RR term on net.
	W	W	W	GN term on net.
	O-BK	O-BK	O-BK	C term on net.
		G-W	G-W	C term on net.
		V	V	*IR speakerphone lead
		O	O	*TI speakerphone lead
			S-BK	RR term on net.

* Connect these leads to spare terminals on network, terminal board, or key terminal as required.

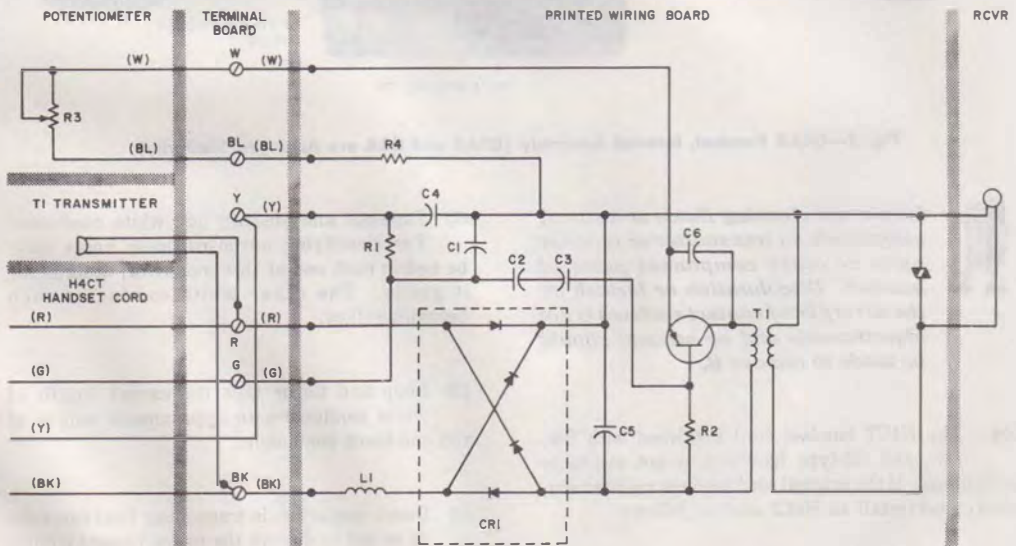

Fig. 3—G6B Handset, Schematic

♦ TABLE C ♦

**G13-TYPE HANDSET AND TOUCH-TONE COIN
COLLECTOR/TELEPHONE CONNECTIONS**

HANDSET LEADS	G13A		G13B
	1234G TEL SET	1239G TEL SET	1A2, 2A2, 1C2, 2C2 TEL SET
	CONNECT TO	CONNECT TO TB4	CONNECT TO TB2
R	TR	R	Term. 3
BK	BB	BK	Term. 5
Y	BBX	W*	Term. 8
G	W	W†	Term. 7

* Connect the (Y) handset lead to the *W* terminal with the (W) lead going to terminal 2 of TB2.

† Connect the (G) handset lead to the *W* terminal with the (W) lead going to terminal 10 of TB2.

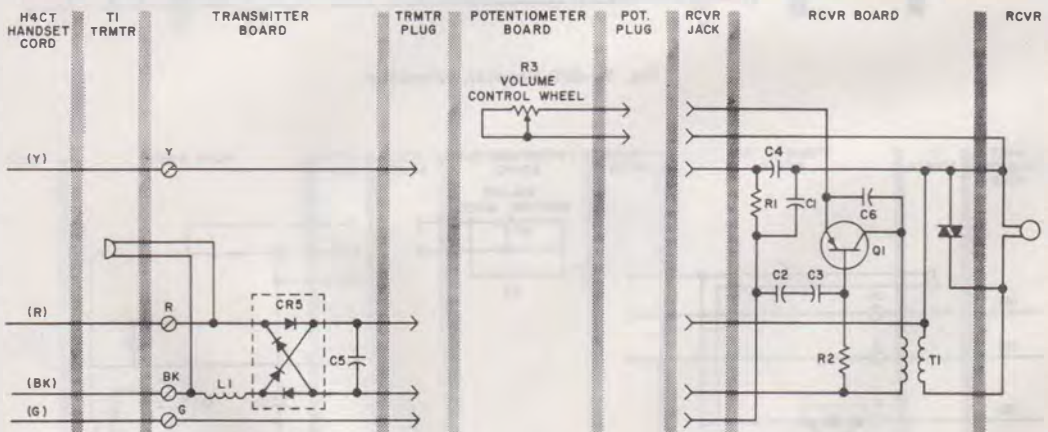

Fig. 4—G6AR Handset, Schematic

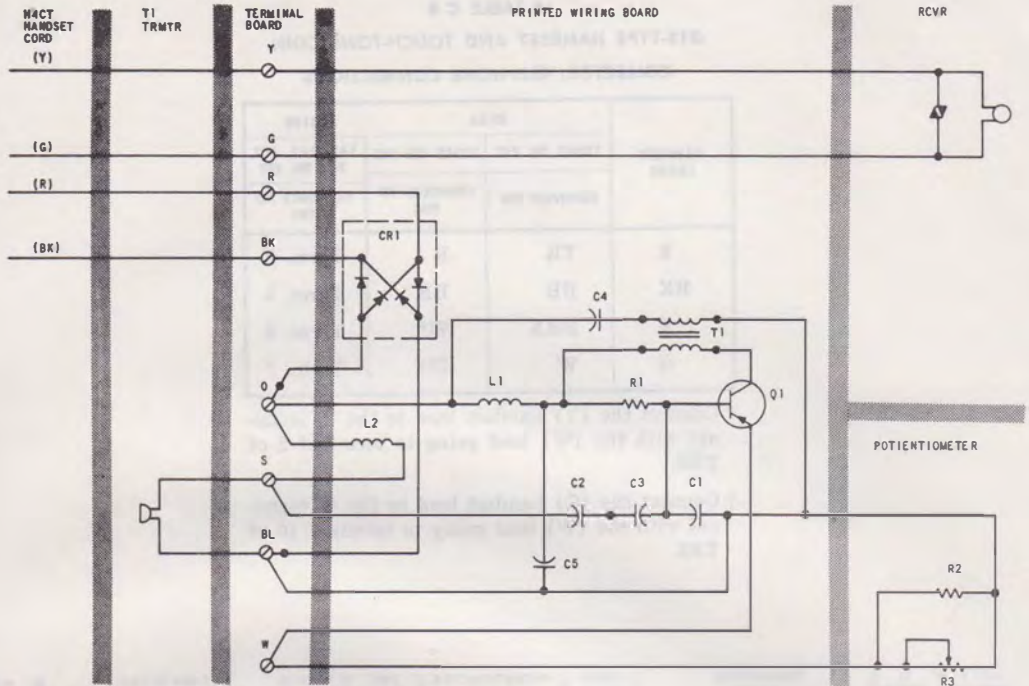

Fig. 5—G7B Handset, Schematic

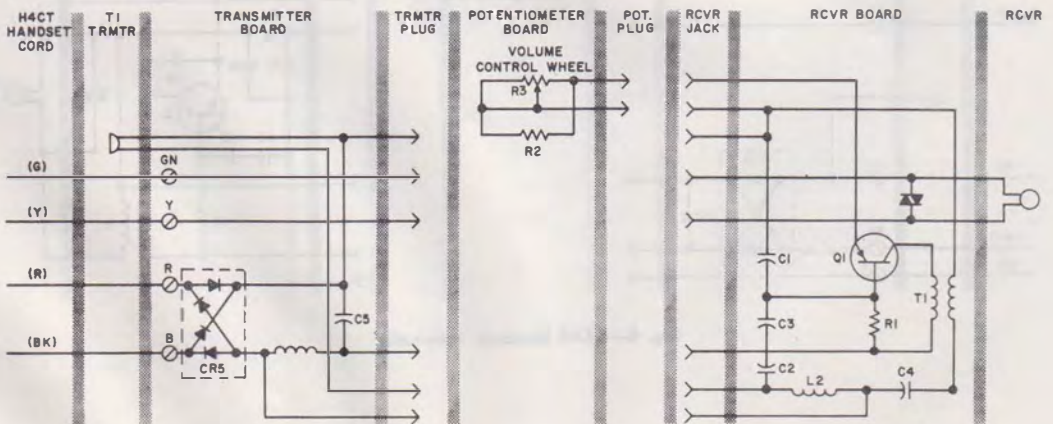

Fig. 6—G7AR Handset, Schematic

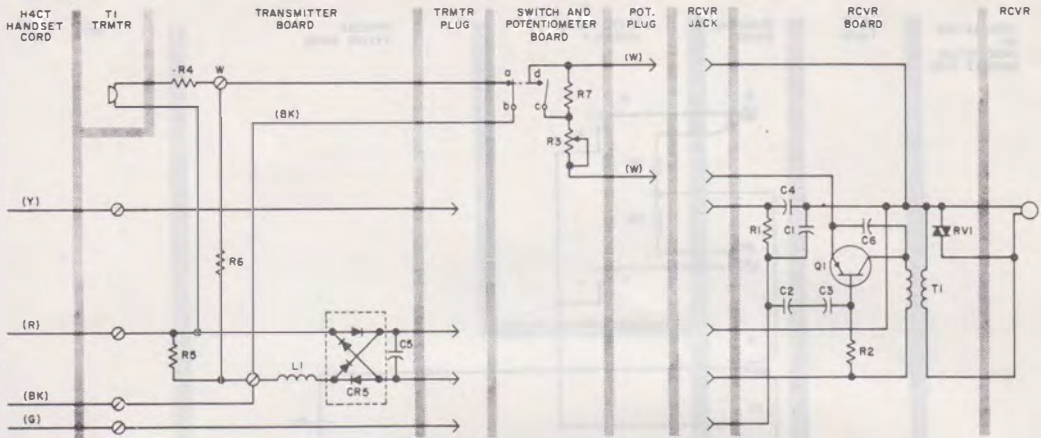

Fig. 7—G8A Handset, Schematic

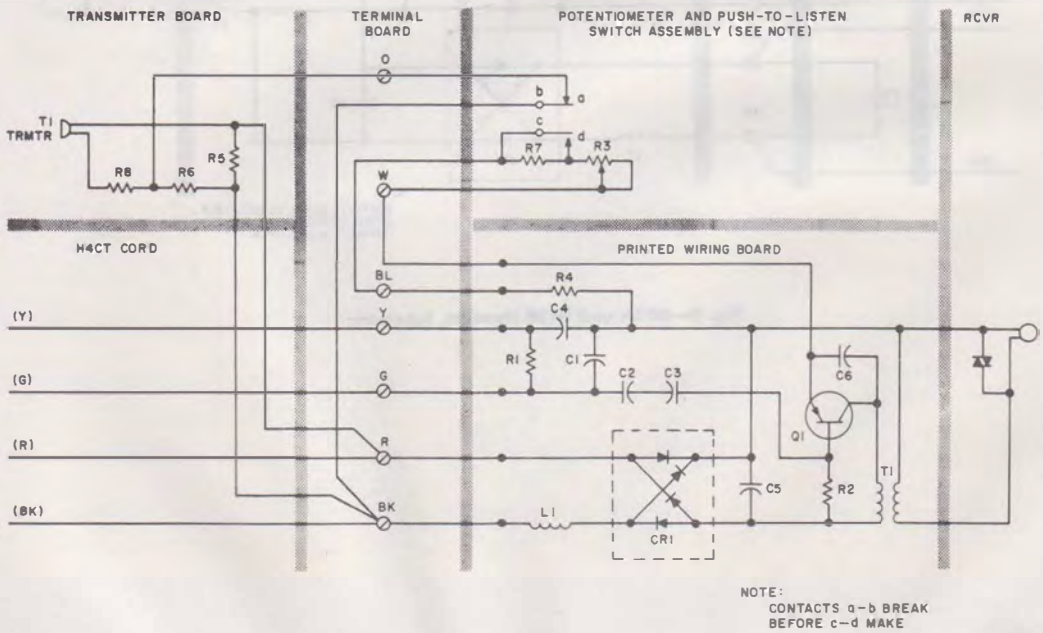

Fig. 8—G8B Handset, Schematic

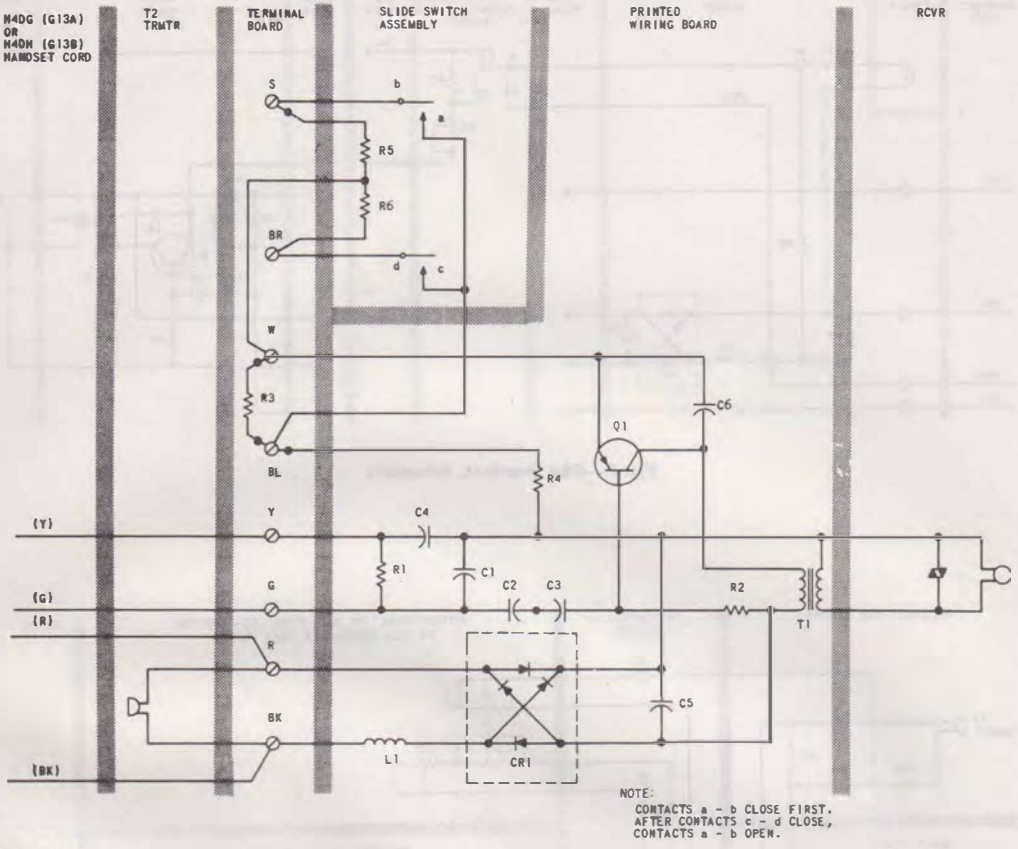

Fig. 9—G13A and G13B Handset, Schematic