

REFERENCE

**500E/F, 500H, 500L/M, 500P, 500R/S, 500U, 500W, 500Y, 500AD,
501F, 501P, 501U, 514B, AND 516B TELEPHONE SETS**

1. GENERAL

1.01 This section provides identification, installation, maintenance, and connection information for special purpose 500-type telephone sets.

1.02 This section is reissued to:

- Add C4B ringer and 516B telephone set.
- Add Tables B and G.
- Show G3AR handset and 241A amplifier MD and replaced by G3A4 handset and 241B amplifier, respectively.
- Reference Section 502-500-110 for common installation and maintenance information (3.01 and 4.01).
- Add note to Tables E and I regarding inductive noise.
- Revise connection diagrams and tables.
- Show housing assembly P-87C100 (514B set) replaced by housing assembly 840205--.
- Show 500E/F, 500L/M, and 501F telephone sets MD.

Changes or additions in the body of tables are indicated by shaded areas.

1.03 Code numbers such as 500E/F cover both manual and dial versions, respectively, of the same type telephone set to permit converting to either type without changing the code number stamped on the base. The letter **R** was added to the code number of some sets at one time to indicate the set was equipped with a retractile handset cord.

2. IDENTIFICATION

Purpose

2.01 The 500- and 501-type telephone sets are single line sets for use in common battery areas, manual or dial.

Ordering Guide

2.02 All parts of the set enclosed by the housing mount on the metal base. The network and line switch are riveted to the base and are not replaceable. Table A lists components of these sets.

2.03 These sets are available in all standard colors as indicated in Section 500-120-100. Components available in color include the dial or apparatus blank, handset, mounting cord, and housing. Components other than the housing must have the code completed by adding the desired color suffix. The housing P- number must have the desired color suffix substituted for its last two digits.

2.04 Housing assembly P-87C100 has been replaced by housing assembly 840205--. Refer to Table B for color ordering information.

Design Features

2.05 501-type telephone sets are identical to a similarly coded 500-type set except for the addition of a 3-element, cold-cathode, gas-filled tube, coded 426A. The 514B set provides jacks for use with 52- or 53-type headsets.

(a) **500E/F (MD) and 501F (MD):**

- Equipped with P-19A411 plunger switch (Fig. 5) to avoid interference with dialing or talking of another customer on a party line.
- With set off hook, only the receiver is bridged on the line as a monitor until the

TABLE A
TELEPHONE SET COMPONENT PARTS

SET	CODE (SEE NOTE)	COMPONENT								
		DIAL	APP BLANK §	NET.	RINGER	HANDSET	MTG CORD	TUBE	HOUSING ASSY	
500	E-, F-Type* ER, FR	9C†	95C	425E**	C4A††	G1- or G3- Type	D3BN	426A	P-80D500	
	H*								P-80E100	
	L-, M-Type* LR, MR		95C		C4-Type		D4BJ		P-80D200	
	P-Type* PR				C4A††				P-80E100	
	R-, S-Type* RR, SR	9H‡	95C		C4-Type		D10P		P-80D200	
	U-Type* UR	9C†			C4A††		D4BJ		P-80E300	
	WR		95C		C4-Type		D3BN		P-80K000	
	YR	9C†							P-80E100	
AD	9H			N1A or T1A	G3-Type	D20K		P-20F185§§		
501	F-Type* FR	9C†		425E	C4A††	G1- or G3- Type	D3BN	426A	P-80D500	
	P-Type* PR								D4BJ	P-80E100
	U-Type* UR									P-80E300
514	B				N1A	G3-Type	D10P	P-87C100 or 840205 - - - (See Table B)		
516		9C			C4-Type		D6AA	P-88A500		

* MD

† Replaces 7C or 7D dial

‡ Replaces 7G or 7H dial

§ Replaces 95A or 95B apparatus blank

** Replaces 425B network

†† Early models had C2A ringer

‡‡ Early models had C3A ringer

§§ N1A ringer included

Note: The letter R indicates set is equipped with a retractile handset cord.



Fig. 1 — 500F, M, S, or 501F Telephone Set



Fig. 2 — 500U or 501U Telephone Set



Fig. 3—500W/Y Telephone Set

plunger switch is lifted to connect the talking and dialing circuits.



Fig. 4—500AD Telephone Set

(b) **500L/M (MD):**

- Supplied wired for 1A1 or 1A2 key telephone system. Can be wired for separate ringer circuit.
- Earlier sets which were converted for 1A1 or 1A2 key telephone system use will have



Fig. 5—500F or 501F Telephone Set, Plunger Switch

an asterisk (*) stamped on the base after the code number.

- Equipped with 4-conductor mounting cord.
- Current model sets are not equipped with a terminal strip (Fig. 6).

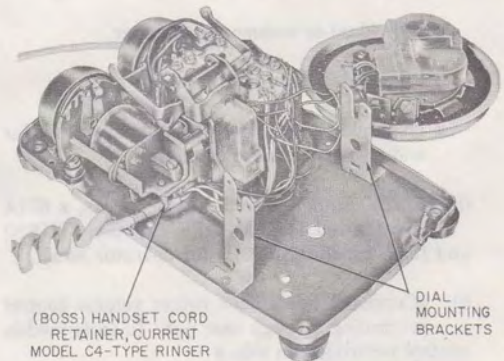

Fig. 6—500L/M Telephone Set, Interior View, Current Model

(c) **500H (MD), P (MD), and 501P (MD):**

- Includes GE46 dial lamp which lights when the handset is lifted.

- A 6-8 volt ac or dc power source must be provided.
- (d) **500U (MD) and 501U (MD):**
- Equipped with 584C key, a GE46 lamp, and a resistor to provide dial-light/night-light feature. When key is in ON position, lamp operates at reduced brilliance for night light.
 - When handset is lifted off hook, lamp lights at full brilliance.
 - A 6-8 volt ac or dc power source must be provided.
- (e) **500R/S (MD):** Factory-wired for speakerphone.
- (f) **500W/Y:** Equipped with a KS-19527L1 neon lamp to provide message waiting service.
- (g) **500AD:**
- Factory-wired for use with 4-wire private line circuits and 3-type speakerphone.
 - Can be modified for use on 2-wire line such as individual lines or 1A1 and 1A2 key telephone system.
 - Individual or common line ringer.
 - Plug-ended mounting cord.
 - Expanded line switch with spare transfer and two spare make contacts.
- (h) **514B:** Equipped with headset jacks, a 637A key for headset ON-OFF function (TURN) and flash function (PUSH) for operator recall.
- (i) Current models have ringer volume control protruding through base pan. In early models control protrudes on side.
- (j) **Kits of Parts (Optional):**
- The 514B telephone set may be equipped with a neon indicator lamp by using a D-179969 Kit of Parts or a filament type lamp using a D-179968 Kit of Parts. When required install kits as follows:
 - (1) Remove housing from set.
 - (2) Remove cap (Fig. 12) from housing by removing screw and clamp located inside housing assembly, discard cap.
 - (3) Install P-17A123 bracket at location shown in (Fig. 13) and attach P-27E389 (bayonet base) or P-13A264 (screw base) lamp socket assembly to bracket arm.
 - (4) Install KS-19527L1 lamp (ordered separately) in bayonet type socket and appropriate lamp for power supply used when screw type socket is installed.
 - (5) Make necessary connections in accordance with appropriate connection section.
 - (6) Install P-11E100 lamp cap assembly on housing of set.
- Note:** To prevent pilferage of the lamp cap assembly a P-14E582 retainer ring (Fig. 10) may be installed. Order separately. Install ring by pressing two tabs together and inserting into the lamp cap slots (Fig. 11). This prevents normal rotation and removal of the lamp cap.
- (7) Replace housing on set.
- (k) **516B:**
- Equipped with turnkey which activates an external make-busy circuit and illuminating a lamp on the set as an indication of key operation.
 - Initial use with 802A hotel/motel PBX system.
- (l) **P-44E420 Jack and Component Assembly** (includes 241A amplifier, and N1A ringer).
- (m) **SIB-2416 Subscriber Instruction Booklet** (shipped loose)

3. INSTALLATION

- 3.01** For installation information on housings, mounting cords, apparatus blanks, and buzzers refer to common installation and maintenance Section 502-500-110.

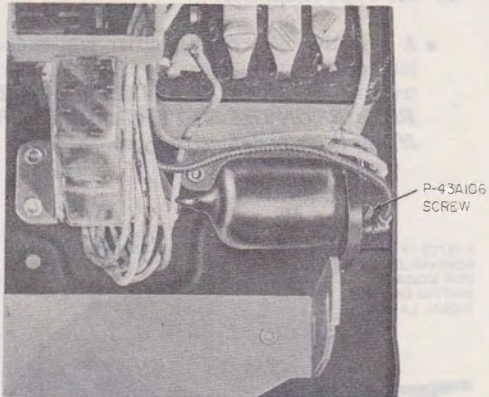

Fig. 7—501-Type Telephone Set, Tube Assembly

(a) **Ringer:**

- Mounted to base with two P-43A456 washerhead mounting screws in rubber grommets.
- Ringer off position can be provided, when authorized locally, by bending back ringer stop spring to provide a fifth position (OFF) on the ringer volume control.

Note: Current model C4-type ringers are equipped with a handset cord retainer (boss) for use with 500- and 501-type telephone sets (Fig. 6).

- (b) **Handsets:** The G1- or G3-type handsets in these sets may be replaced by a G6AR (MD) or G6B handset for impaired hearing, a G7AR for weak speech, or a G8A (MD) or G8B for noisy locations. Refer to section covering amplifier handsets for additional information.

4. MAINTENANCE

4.01 ♦ For maintenance information on plungers, bracket switch assemblies and switch contacts, refer to Section 502-500-110, Common Installation and Maintenance.

4.02 Current models of the 500L/M, 500R/S, 500W, and 500Y are equipped with a C4B (two lead) ringer. When ringer replacement is

necessary in sets having a C4A (four lead) ringer changes are required when a C4B is used (Fig. 17, 18, 20, and 22).♦

(a) **Tube Assembly:**

- Where excessive power induction exists, a 425A, 4-element tube may be substituted for 426A. See section on inductive noise.
- Tube assembly is held to base of set with single screw (Fig. 7).

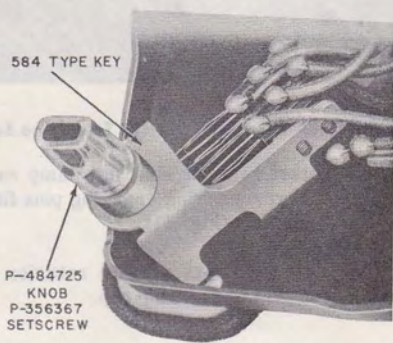

Fig. 8—Typical Turn Key

- (b) **Dial Light:** To remove, turn lamp cap and lamp counterclockwise (Fig. 9) and lift out.

(c) **Lamp Cap Retainer Ring:**

- 500W/Y and 514B telephone sets can be equipped with P-14E582 retainer ring (Fig. 10) to prevent pilferage of the lamp cap assembly.
- Install retainer ring as follows:
 - (1) Remove set housing with lamp cap in place.
 - (2) Press two tabs of retainer ring together.



Fig. 9—Lamp Assembly, 500H/P Telephone Set

- (3) Insert retainer ring into lamp cap so that retainer ring engaging pins fit into lamp cap slots (Fig. 11).
- (4) This prevents normal rotation and removal of the lamp cap.

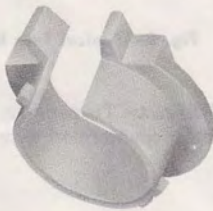

Fig. 10—P-14E582 Retainer Ring

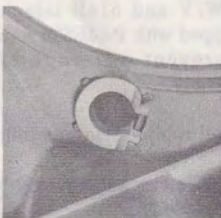
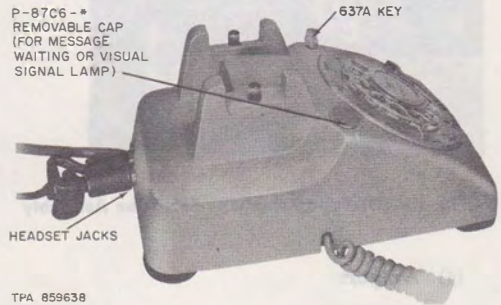

Fig. 11—Retainer Ring Mounted in Set Housing

(d) **241-Type Amplifier:**

- A defective 241-type amplifier will cause loss of or low output from the headset transmitter. **DO NOT ATTEMPT FIELD REPAIRS ON THE 241-TYPE AMPLIFIER. If amplifier is defective, replace.**

*ADD COLOR SUFFIX



TPA 859638

Fig. 12—514B Telephone Set

♦TABLE B♦

HOUSING ASSEMBLY FOR 514B TELEPHONE SET

COLOR	PART NO.
Black	840205033
Ivory	840205504
Moss Green	840205512
Red	840205538
Yellow	840205561
White	840205587
Rose Pink	840205595
Light Beige	840205603
Light Gray	840205611
Aqua Blue	840205629
Turquoise	840205645

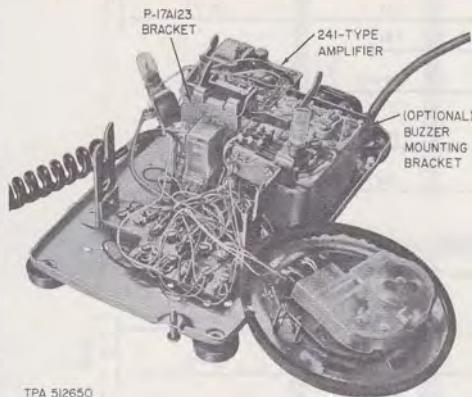

TPA 512650

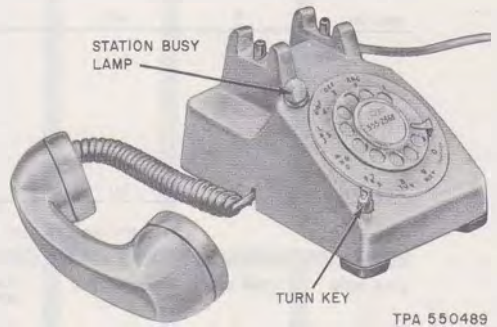

TPA 550489

Fig. 14—516B Telephone Set

Fig. 13—514B Telephone Set, Interior View

TABLE C

LINE AND RINGER CONNECTIONS FOR 500E/F, 501F, AND 500H TELEPHONE SETS

WIRE OR LEAD	COLOR	BRIDGED	RING PARTY	TIP PARTY NO IDENT GRD	NEG(-) PARTIES		POS(+) PARTIES	
					RING	TIP	RING	TIP
					1 AND 5	2 AND 6	3 AND 7	4 AND 8
Ringer (Note)	R	L2	L2	L2	G	G	L2	L2
	BK	(G) <F>	G	G	G	G	L2	L2
	S	K	K	K	A	A	A	A
	S-R	A	A	A	K	K	K	K
426A Tube (501F and 500H)	R				(L1-G) <F-G>	(L1-G) <F-G>	L2	L2
	BK				K	K	K	K
	Y				L2	L2	G	G
Mtg Cord Conn Block End	R	R	R	G	G	R	R	G
	G	G	G	R	R	G	G	R
	Y	(G) <Y>	Y	Y	Y	Y	Y	Y
	BK	B	B	B	B	B	B	B
Inside Wire at Conn Block	Ring	R	R	R	R	R	R	R
	Tip	G	G	G	G	G	G	G
	GRD	Y	Y	Y	Y	Y	Y	Y
Trnsf Leads at Conn Block		<Y>	<Y>	<Y>	<Y>	<Y>	<Y>	<Y>
								

Note: To silence ringer permanently disconnect R and BK ringer leads and insulate and store.

() 500E/F and 501F (Fig. 15).

<> 500H (Fig. 16).

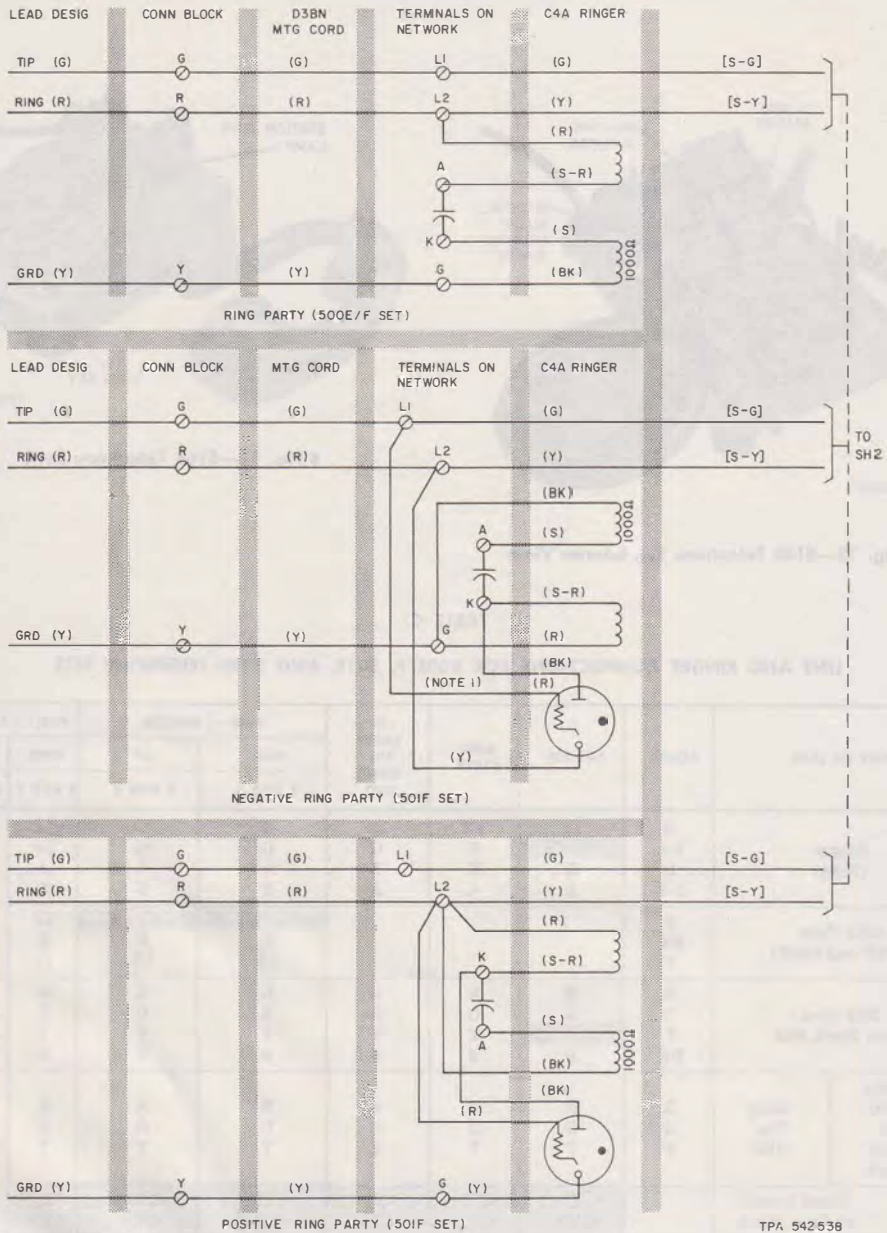
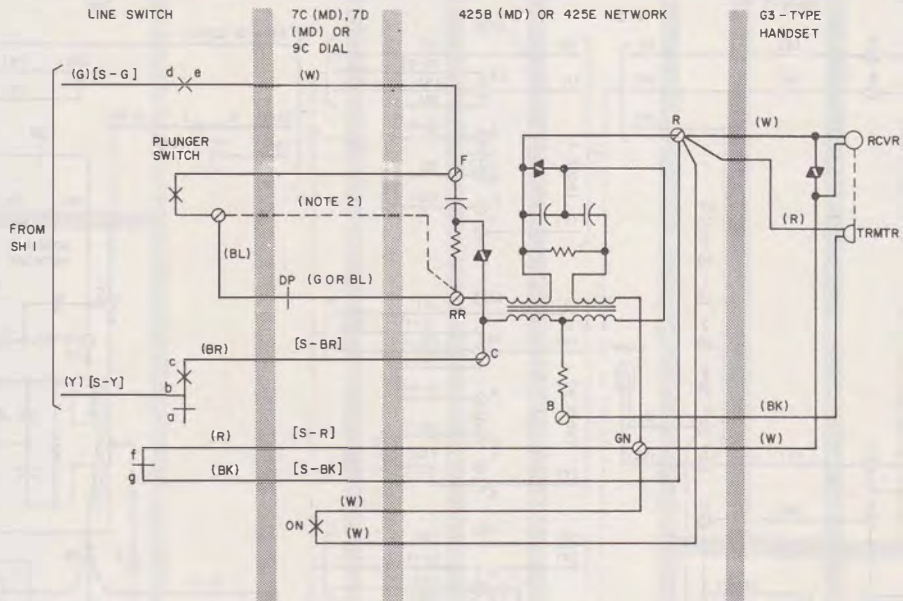

Fig. 15—500E/F and 501F Telephone Set, Connections (Sheet 1 of 2) ◀



NOTES:

1. FOR NEGATIVE STATIONS IN OFFICES WITHOUT ANI, (R) LEAD FROM 426A TUBE MAY BE CONNECTED TO G IF RINGER OPERATION IS MARGINAL.
 2. FOR MANUAL SERVICE REMOVE DIAL AND ADD STRAP.
 3. LINE SWITCH SEQUENCE, HANDSET REMOVED.

(1) bc MAKES	(3) ab BREAKS
(2) de MAKES	(4) fg BREAKS
- () CURRENT COLOR CODE
 [] MD COLOR CODE
 DP DIAL PULSE CONTACT
 ON DIAL OFF-NORMAL CONTACT

TPA 54253B

♦Fig. 15—500E/F and 501F Telephone Set, Connections (Sheet 2 of 2)♦

TABLE D

LINE AND RINGER CONNECTIONS FOR 500L/M TELEPHONE SET

FEATURES (SEE NOTES 3 AND 5 FIG. 17 AND NOTE 3 FIG. 18)	TERM. STRIP	CONNECTIONS TO TERMINALS IN SET										MTG CORD CONNECTIONS ON CONN BLOCK					
		MTG CORD				C4A RINGER LEADS (SEE NOTE)				C4B RINGER LEADS		LINE		RINGER		CONTROL LEAD	
		R	G	Y	BK	R	BK	S	S-R	R	BK	RING	TIP	RING	TIP	A1	A
3 Ringer Circuit Brought Out Separately in Mtg Cord	With			3†	4†	4†	3†					3†					
	With- out	L2	F	L1*	G*	G	L1	A	A	A	L1	R	G	Y	BK		
4 Control Leads for 1A1, 1A2 Key Telephone Systems and 101-Type Key Equipment	With			5†	6†												
	With- out	L2	F	L1	G	L2	F	K	A	K	F	R	G			Y	BK

* Remove, insulate, and store (BR) and (Y) line switch leads.

† On term. strip.

◆ Note: (S) strap is not used and should be removed.◆

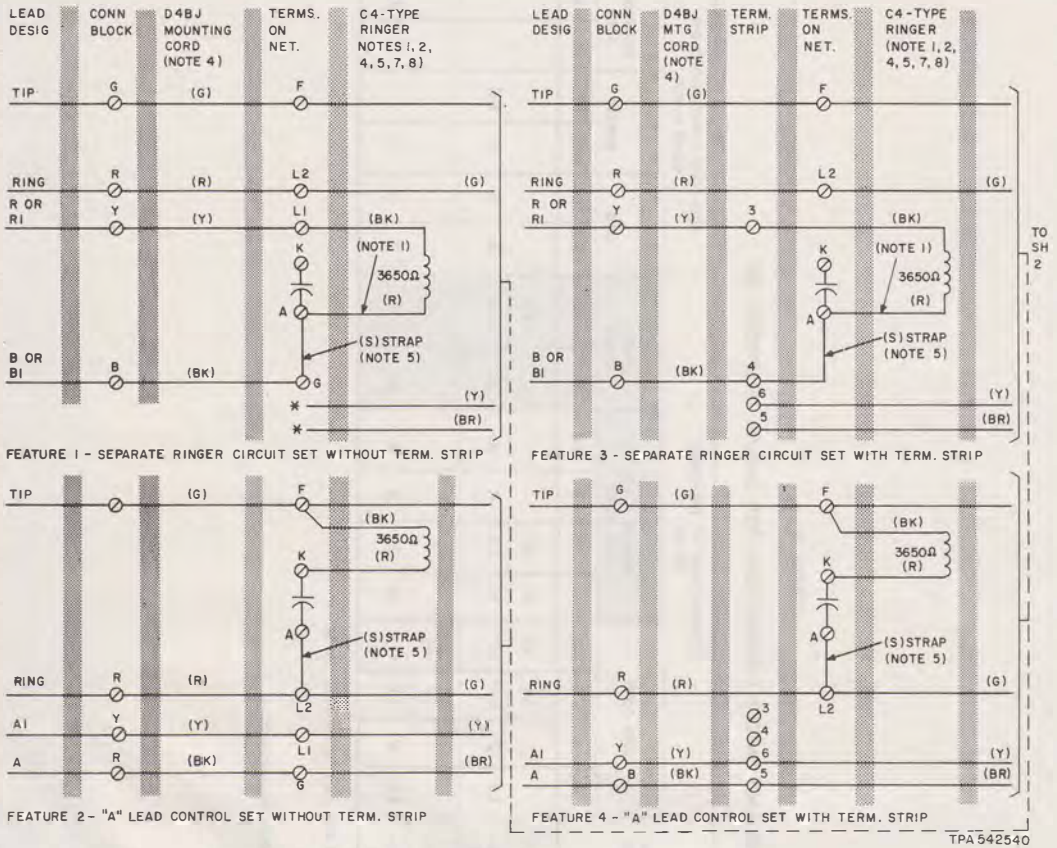

◆ Fig. 17—500L/M Telephone Set, Current Connections With and Without Terminal Strips (Sheet 1 of 2) ◆

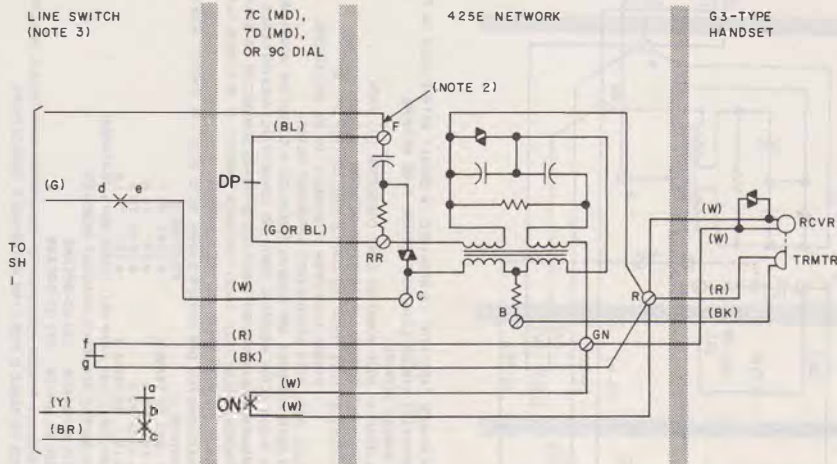

NOTES:

- WHEN RINGER CAPACITOR IS REQUIRED IN SERIES WITH RINGER ON FEATURE 1 OR 3, TRANSFER (R) RINGER LEAD TO TERMINAL K ON NETWORK.
 - FOR MANUAL SERVICE:
 - FEATURES 1 AND 3 - MOVE MOUNTING CORD CONDUCTOR (G) FROM TERMINAL F TO RR ON NETWORK.
 - FEATURES 2 AND 4 - MOVE MOUNTING CORD CONDUCTOR (G) AND (BK) RINGER LEAD FROM TERMINAL F TO RR ON NETWORK. REPLACE DIAL WITH APPROPRIATE APPARATUS BLANK.
 - TO PREVENT FALSE HOLD CONDITION WHEN HANDSET IS RESTORED, SWITCH CONTACTS d,e MUST BREAK BEFORE b,c BREAK.
 - WHEN BOTH FEATURES ARE REQUIRED, REPLACE 4-CONDUCTOR MOUNTING CORD WITH 6-CONDUCTOR CORD AND CONNECT (BL) AND (W) LEADS TO (BK) AND (R) RINGER LEAD RESPECTIVELY. USE DI61488 CONNECTORS OR SPARE TERMINALS.
 - CONNECTIONS FOR C4B RINGER SHOWN. SETS WITH C4A RINGER WIRED AS FOLLOWS:

FEATURE 1	FEATURE 3	FEATURES 2 AND 4
● (BK) TO L1	● (BK) TO TERM. 3	● (BK) TO F
● (S) TO A	● (S) TO A	● (S) TO K
● (S-R) TO A	● (S-R) TO A	● (S-R) TO A
● (R) TO G	● (R) TO TERM. 4	● (R) TO L2

REMOVE (S) STRAP FROM NET. TERMS. (ALL FEATURES)
 - LINE SWITCH SEQUENCE HANDSET REMOVED.
 - (1) bc - MAKES
 - (2) de - MAKES
 - (3) fg - BREAKS
 - REFER TO TABLE D FOR LINE AND RINGER CONNECTIONS.
 - TO SILENCE RINGER PERMANENTLY DISCONNECT (BK) RINGER LEAD INSULATE AND STORE.
- DP - DIAL PULSE CONTACT
ON - DIAL OFF-NORMAL
* - INSULATE AND STORE

TPA 542540

♦ Fig. 17—500L/M Telephone Set, Current Connections With and Without Terminal Strips (Sheet 2 of 2) ♦

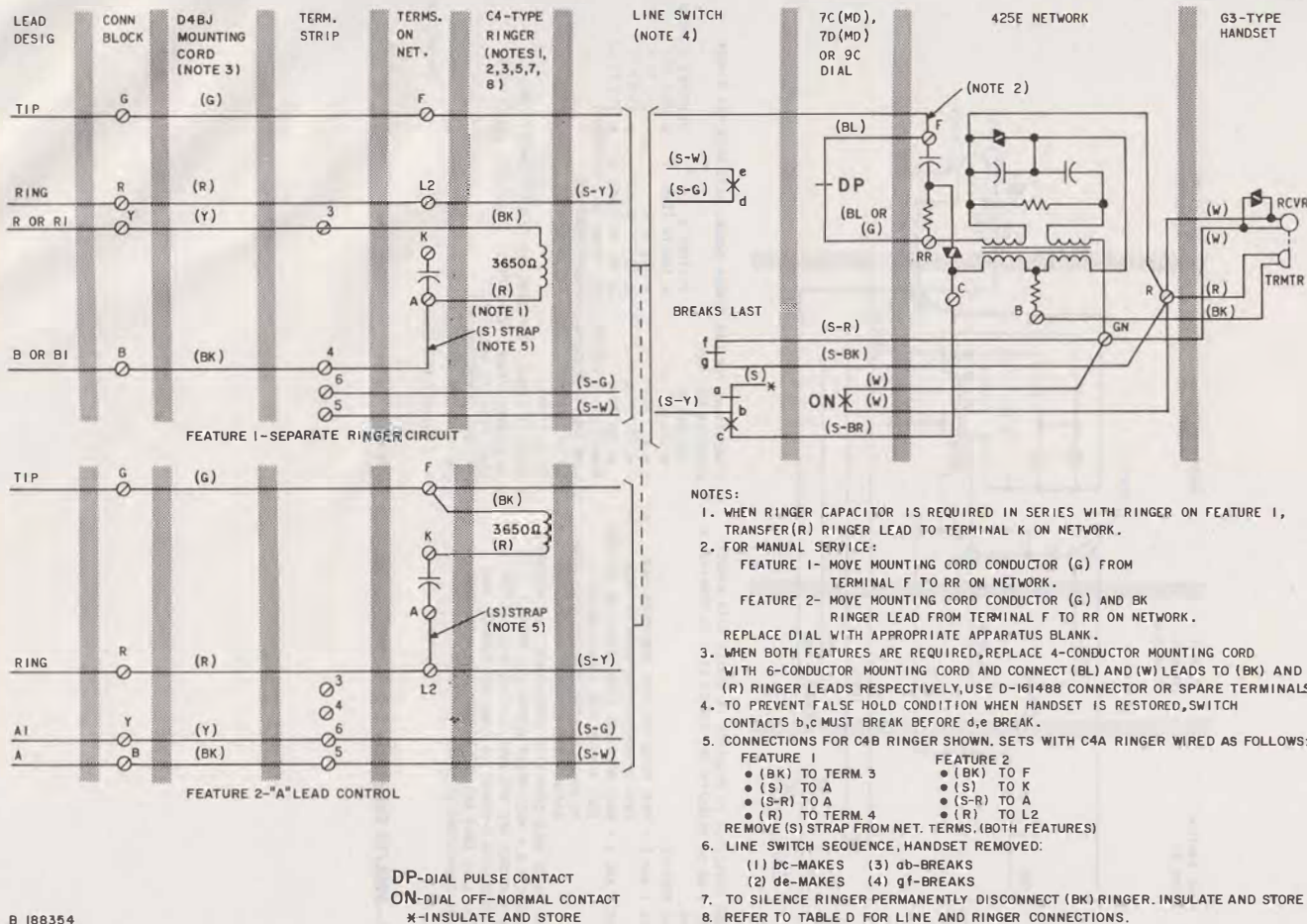

B 188354

◆ Fig. 18—500L/M Telephone Set, Connections With (MD) Line Switch and Lead Colors ◆

TABLE E
LINE, RINGER, AND TUBE CONNECTIONS FOR 500P AND 501P TELEPHONE SETS

WIRE OR LEAD	COLOR	BRIDGED *	RING PARTY *	TIP PARTY NO IDENT GRD*	TIP PARTY IDENT GROUND						NEG(-) PARTIES†		POS(+) PARTIES†	
					NORMAL CONNEC-TIONS		RINGER REV. WHEN CONN TO L.L. EQUIP.		TO SILENCE RINGER PERMA-NENTLY		RING	TIP	RING	TIP
					1000Ω	2650Ω	1000Ω	2650Ω	1000Ω	2650Ω	1 AND 5	2 AND 6	3 AND 7	4 AND 8
Ringer	R	L2	L2	L2	K	B	B	G	K	B	G	G	L2	L2
	BK	L1	G	G	G	B	B	K	G	K	G	G	L2	L2
	S S-R	K A	K A	K A	B B	K G	G K	B B	B K	K G	A K	A K	A K	A K
Line Switch	S	L2	L2	L2	A	A	A	A	L2	L2	L2	L2	L2	L2
426A Tube (501P Set)	R BK Y										L1 or G K L2	L1 or G K L2	L2 K G	L2 K G
Mtg Cord Conn Block End	R G Y BK	R G Y B	R G Y B	G R Y B	G R Y B	G R Y B	G R Y B	G R Y B	G R Y B	G R Y B	R G Y B	G R Y B	R G Y B	G R Y B
Inside Wire Conn Block	Ring Tip GRD	R G Y	R G Y	R G Y	R G Y	R G Y	R G Y	R G Y	R G Y	R G Y	R G Y	R G Y	R G Y	R G Y
Trnsf Leads at Conn Block		Y B	Y B	Y B	Y B	Y B	Y B	Y B	Y B	Y B	Y B	Y B	Y B	Y B

* To silence ringer permanently for these classes of service, connect BK ringer lead to K terminal on network.

† To silence ringer permanently for negative and positive parties, connect yellow strip to terminal 6 instead of terminal 5 on terminal strip.

◆ **Note:** Refer to section on inductive noise for connections using 4-element (425A) tube. ◆

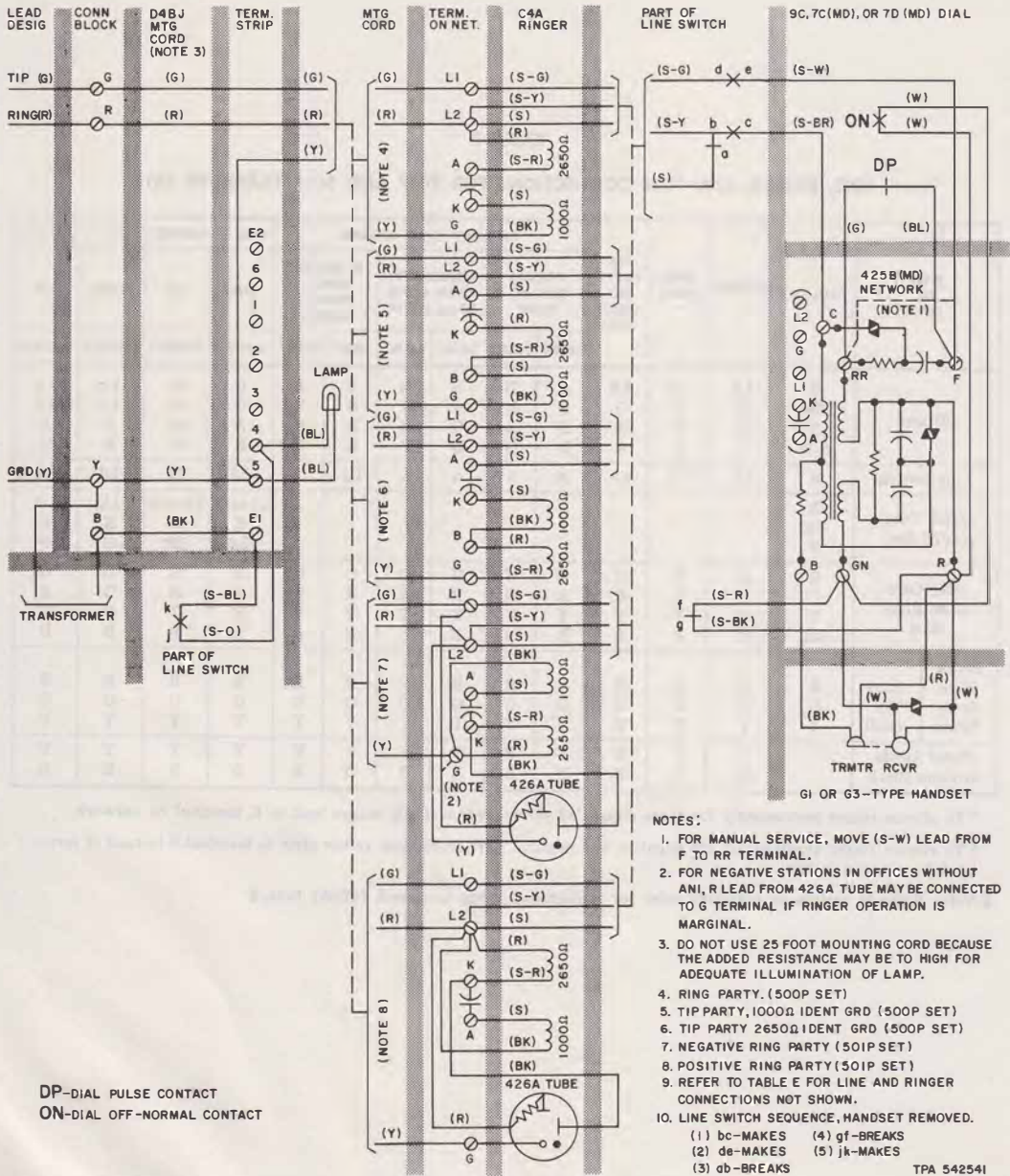

Fig. 19—500P and 501P Telephone Set, Connections

**TABLE F
LINE AND RINGER CONNECTIONS FOR 500R/S TELEPHONE SET E/W C4A RINGER**

WIRE OR LEAD	COLOR	INDIV OR BRIDGED		RING PARTY		TIP PARTY NO INDENT GROUND (NOTE 3)		TIP PARTY IDENT GROUND*													
								NORMAL CONNECTIONS (NOTE 1 AND 3)				RINGER REVERSAL WHEN CONNECTED TO LONG LINE EQUIP. (NOTE 1 AND 3)				TO SILENCE RINGER PERMANENTLY					
								1000Ω		2650Ω		1000Ω		2650Ω		1000Ω		2650Ω			
								DIAL	MAN.	DIAL	MAN.	DIAL	MAN.	DIAL	MAN.	DIAL	MAN.	DIAL	MAN.	DIAL	MAN.
Mtg Cord in Set†	W-BL [G]	G	G	F	E2	F	E2	F	E2	F	E2	F	E2	F	E2	F	E2	F	E2	F	E2
Strap from G Term. on Net. to	(G)	F	E2	E1	E1	E1	E1	E1	E1	E1	E1	E1	E1	E1	E1	E1	E1	E1	E1	E1	E1
C4A Ringer (Note 2)	(R) (BK) (S) (S-R)	L2 G K A	L2 G K A	L2 G K A	L2 G K A	K G B B	K G B B	B B K G	B B K G	B B K G	B B K G	G K B B	G K B B	L1 G B A	L1 G B A	B L1 K G	B L1 K G				
Line Switch	(W-S) [S-BR]	Term. 2	Term. 2	Term. 2	Term. 2	A of Net.	A of Net.	A of Net.	A of Net.	A of Net.	A of Net.	A of Net.	A of Net.	Term. 2	Term. 2	Term. 2	Term. 2	Term. 2	Term. 2	Term. 2	Term. 2
Mtg Cord at Conn Block† (Line Only)	(G-W) [R] (W-BL) [G] (BL-W) [BR-G]	Ring	Ring	Ring	Ring	Tip	Tip	Tip	Tip	Tip	Tip	Tip	Tip	Tip	Tip	Tip	Tip	Tip	Tip	Tip	Tip

Note 1: Use normal connections on a tip party identification ground stations. If bell taps on stations connected to long line equipment, use ringer reversal column in Table F to retain tip party identification.

2. (S) strap is not used and should be removed.

3. Move strap at 44A connecting block from terminal 1 to 2.

* If long line equipment is used, tip party identification connections can be made in a No. 5 crossbar central office ONLY if SD-26129-01 long line equipment is used, or in any type office ONLY if SD-96588-01 long line equipment is used.

† Only the optional mounting cord leads are shown in the table. Connections for the remaining mounting cord leads are shown in Fig. 20.

() Current color code.

[] MD color code.

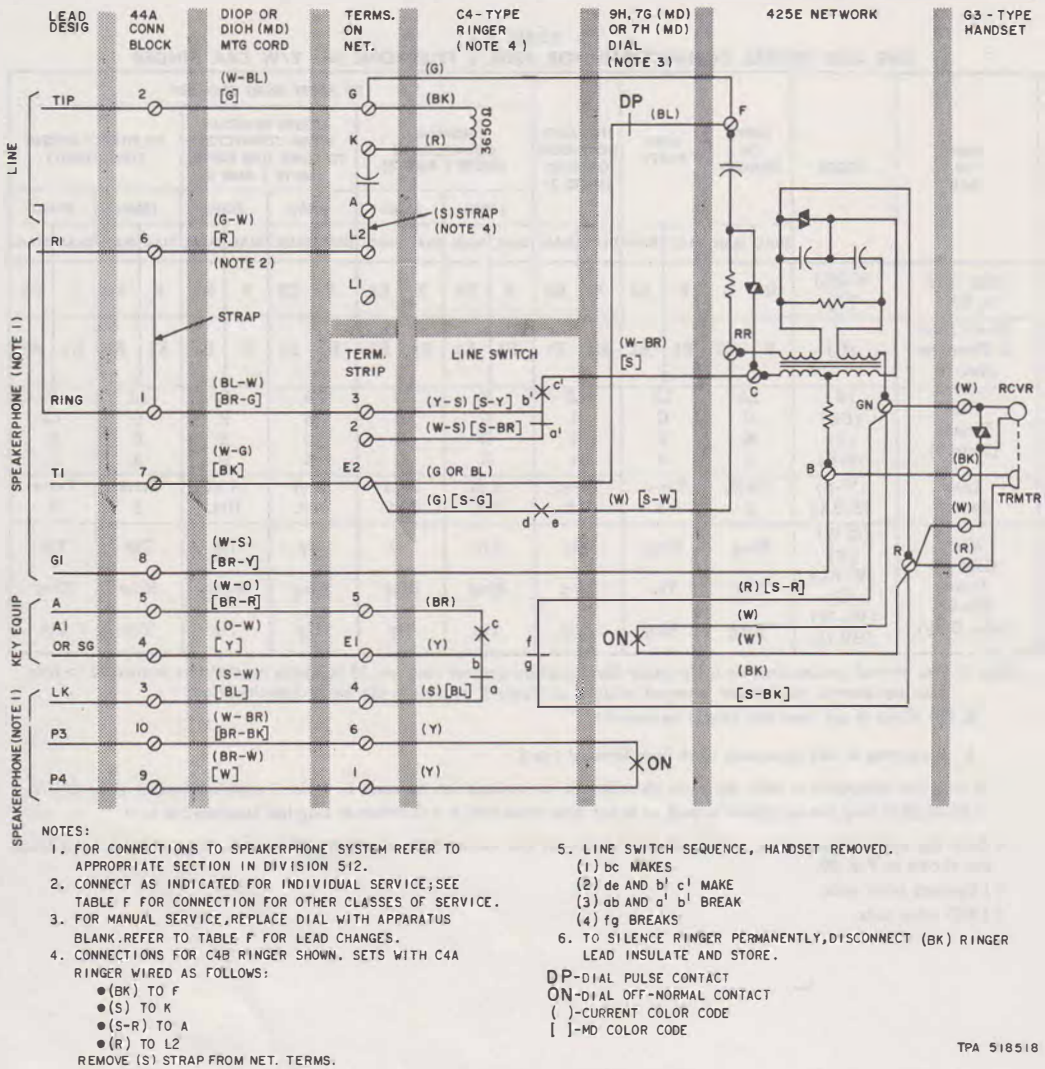

Fig. 20—500R/S Telephone Set, Connections

♦ TABLE G ♦

LINE AND RINGER CONNECTIONS FOR 500R/S TELEPHONE SET E/W C4B RINGER

WIRE OR LEAD	COLOR	INDIV OR BRIDGED		RING PARTY		TIP PARTY NO IDENT GROUND	
		DIAL	MAN.	DIAL	MAN.	DIAL	MAN.
Mtg Cord in Set*	(W-BL) [G]	G	G	F	E2	F	E2
Strap from G Term. on Net. to	[G]	F	E2	E1	E1	E1	E1
C4B Ringer	(R) (BK)	K G		K G		K G	
Mtg Cord at Conn. Block* (Line only)	(G-W) [R] (W-BL) [G] (BL-W) [BR-G]	Ring		Ring		Tip	
		Tip		Tip		Ring	
		Ring		Ring		Tip	

* Only the optional mounting cord leads are shown in the table. Connections for the remaining mounting cord leads are shown in Fig. 20.

() Current color code

[] MD color code

**TABLE H
RINGER LEAD CONNECTIONS
TO SILENCE RINGER PERMANENTLY
FOR 500U AND 501U TELEPHONE
SETS**

CLASS OF RINGING SERVICE	RINGER LEAD			
	R	BK	S	S-R
Individual or Bridged	A	K	K	A
Tip Party Message Rate Zone Registration XBR with AMA	K	G	B	K
Tip Party S X S with AT S X S with AMA MOD XBR with AMA	B	K	K	G
For all classes of service except those listed above: Connect (Y) strap to terminal 6 instead of terminal 5 on terminal strip.				

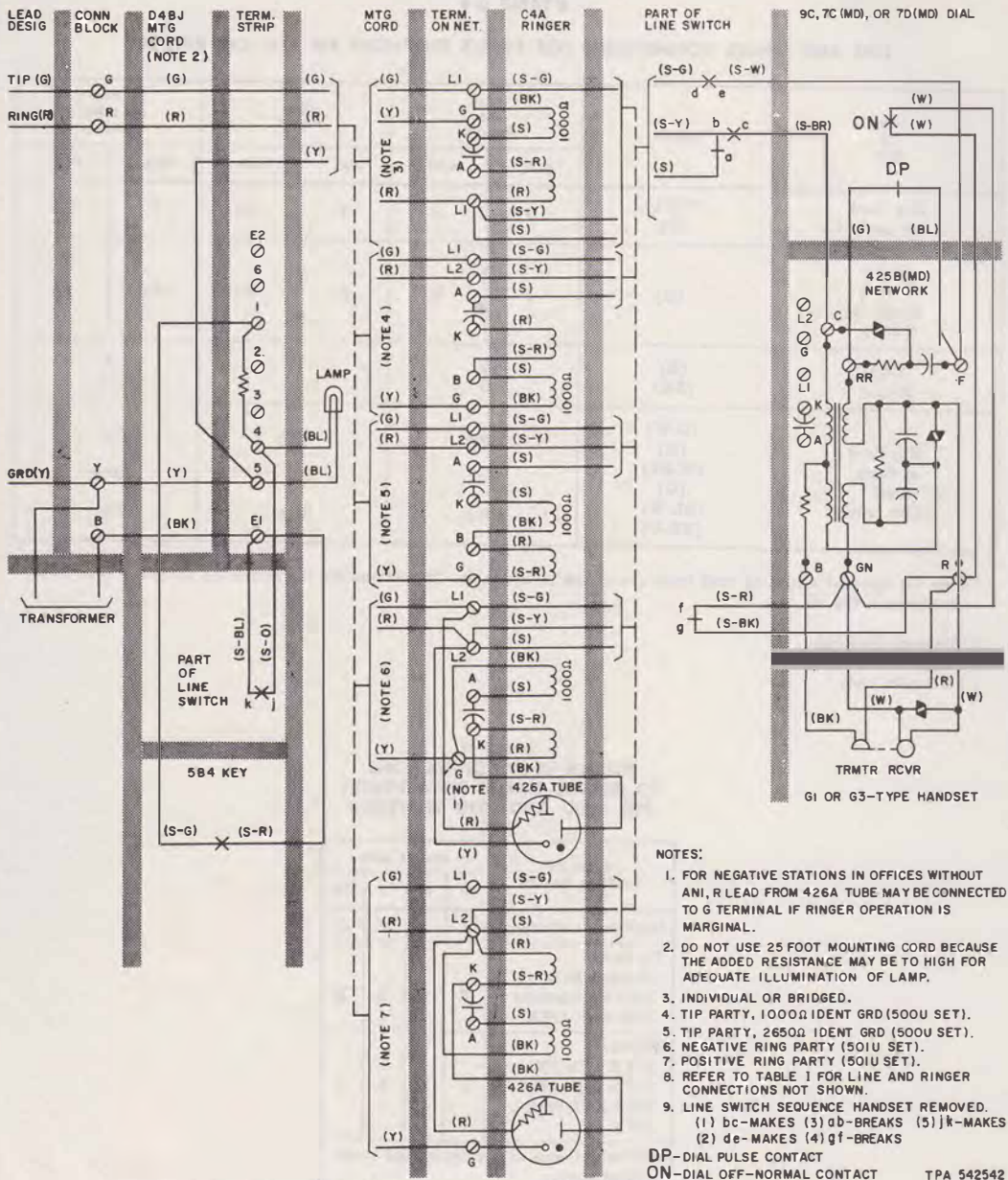

- NOTES:
1. FOR NEGATIVE STATIONS IN OFFICES WITHOUT ANI, R LEAD FROM 426A TUBE MAY BE CONNECTED TO G TERMINAL IF RINGER OPERATION IS MARGINAL.
 2. DO NOT USE 25 FOOT MOUNTING CORD BECAUSE THE ADDED RESISTANCE MAY BE TOO HIGH FOR ADEQUATE ILLUMINATION OF LAMP.
 3. INDIVIDUAL OR BRIDGED.
 4. TIP PARTY, 1000Ω IDENT GRD (500U SET).
 5. TIP PARTY, 2650Ω IDENT GRD (500U SET).
 6. NEGATIVE RING PARTY (501U SET).
 7. POSITIVE RING PARTY (501U SET).
 8. REFER TO TABLE 1 FOR LINE AND RINGER CONNECTIONS NOT SHOWN.
 9. LINE SWITCH SEQUENCE HANDSET REMOVED.
 (1) bc-MAKES (3) ab-BREAKS (5) jk-MAKES
 (2) de-MAKES (4) gf-BREAKS
- DP-DIAL PULSE CONTACT
 ON-DIAL OFF-NORMAL CONTACT
- TPA 542542

◆ Fig. 21—500U and 501U Telephone Set, Connections ◆

TABLE I
LINE, RINGER AND TUBE CONNECTIONS FOR 500U AND 501U TELEPHONE SETS

WIRE OR LEAD	COLOR	BRIDGED	RING PARTY	TIP PARTY NO IDENT GRD	TIP PARTY		NEGATIVE(-) PARTIES		POSITIVE(+) PARTIES	
					IDENTIFYING GROUND		RING	TIP	RING	TIP
					1000Ω	2650Ω				
Ringer	R	L2	L2	L2	K	B	G	G	L2	L2
	BK	L1	G	G	G	B	G	G	L2	L2
	S	K	K	K	B	K	A	A	A	A
	S-R	A	A	A	B	G	K	K	K	K
Line Switch	S	L2	L2	L2	A	A	L2	L2	L2	L2
426A Tube (501U Set)	R						L1 or G	L1 or G	L2	L2
	BK						K	K	K	K
	Y						L2	L2	G	G
Mtg Cord Conn Block End	R	R	R	G	G	G	R	G	R	G
	G	G	G	R	R	R	G	R	G	R
	Y	Y	Y	Y	Y	Y	Y	Y	Y	Y
	BK	B	B	B	B	B	B	B	B	B
Inside Wire at Conn Block	Ring Tip GRD	R	R	R	R	R	R	R	R	R
		G	G	G	G	G	G	G	G	G
		Y	Y	Y	Y	Y	Y	Y	Y	Y
Trnsf Leads at Conn Block		Y	Y	Y	Y	Y	Y	Y	Y	Y
		B	B	B	B	B	B	B	B	B

◆ **Note:** Refer to section on inductive noise for connections using 4-element (425A) tube. ◆

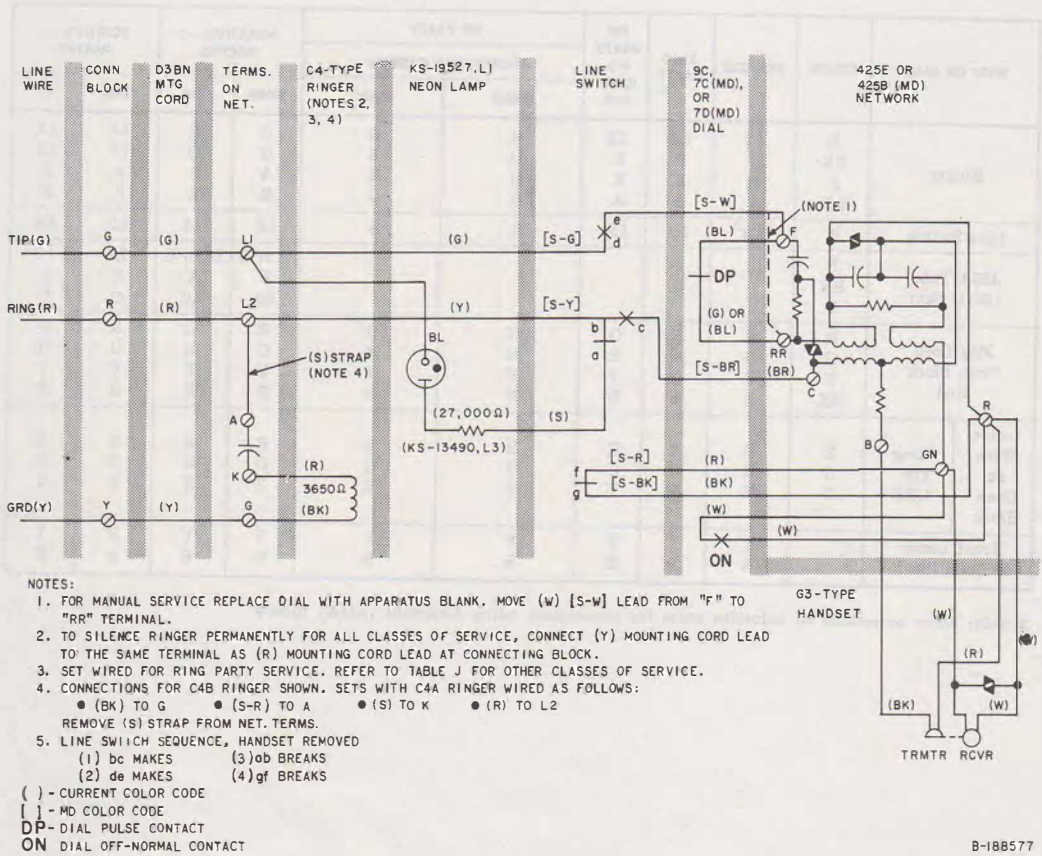

B-188577

Fig. 22—500W and 500Y Telephone Set, Connections

TABLE J
LINE AND RINGER CONNECTIONS
FOR 500W AND 500Y TELEPHONE SETS

WIRE OR LEAD	COLOR	INDIV OR BRIDGED	RING PARTY	TIP PARTY
Mtg Cord in Set	R	L2	L2	L2
	G	L1	L1	L1
	Y	G	G	G
C4A Ringer	R	L2	L2	L2
	BK	G	G	G
	S	K	K	K
	S-R	A	A	A
Neon Lamp	BL	L1	L1	L1
Mtg Cord at Conn Block	R	R	R	G
	G	R	G	R
	Y	G	Y	Y
Inside Wire at Conn Block	R	R	R	R
	G	G	G	G
	Y	Y	Y	Y
C4B Ringer	R	K	K	K
	BK	G	G	G

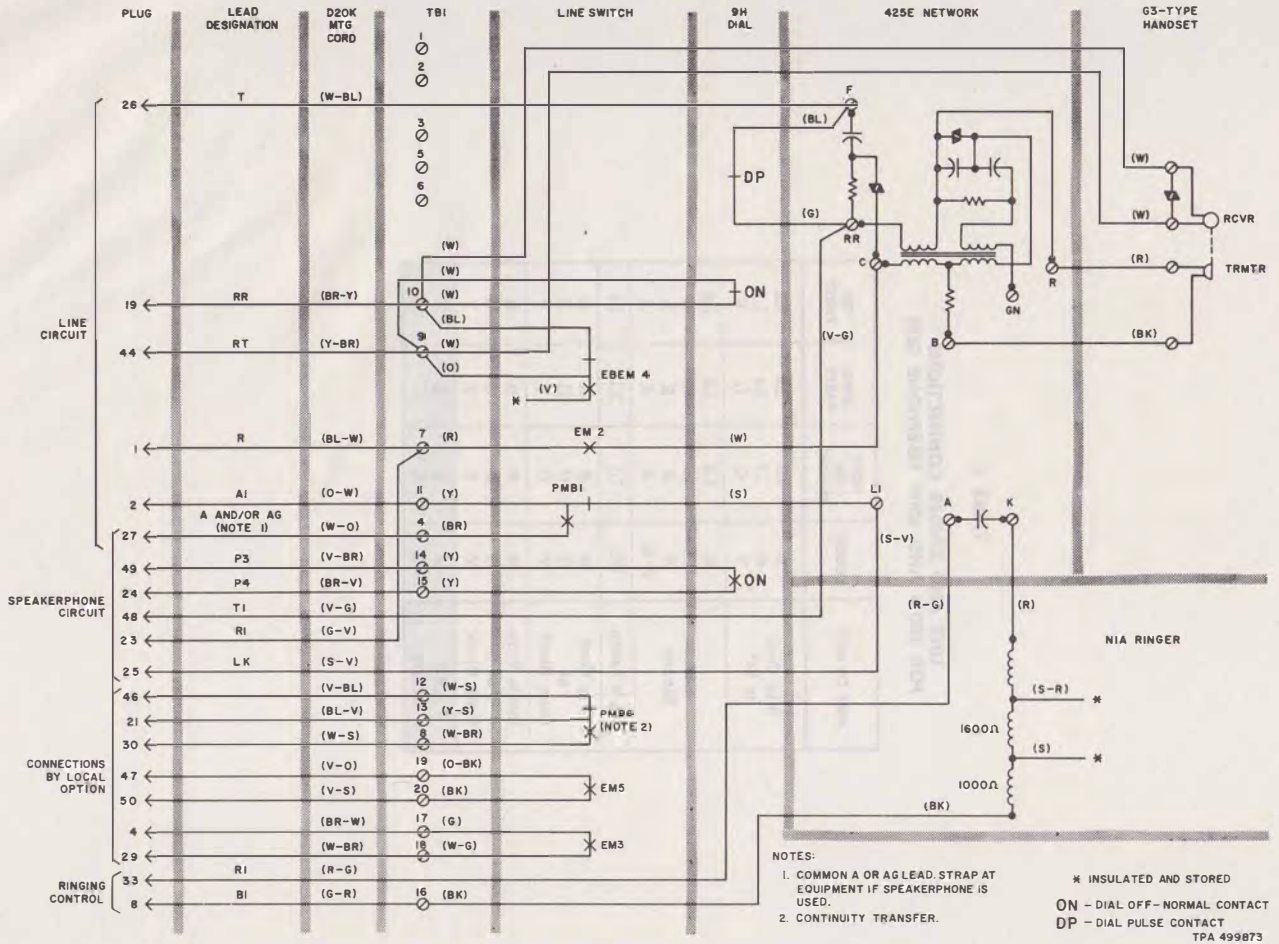

♦ Fig. 23—500AD Telephone Set, Connections ♦

TABLE K
MODIFICATION TO PROVIDE STATION BUSY LAMP
IN 514B TELEPHONE SET

LEAD	COLOR	REMOVE FROM	CONNECT TO
Line Switch	(BR) [S-W]	5	E1
Headset On-Off Key	(BR)	5	E1
KS-15724, L1 Diode			E1  5

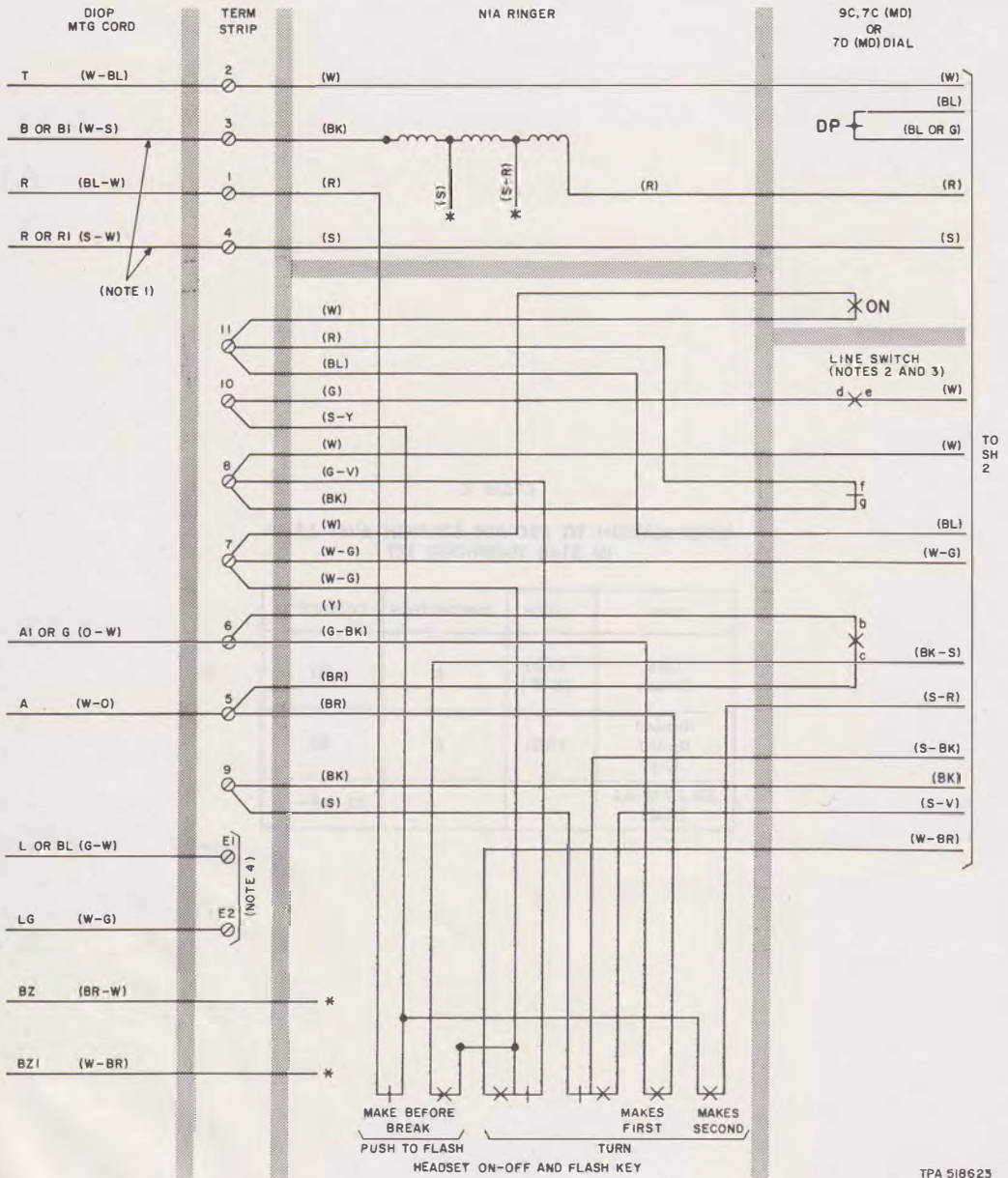
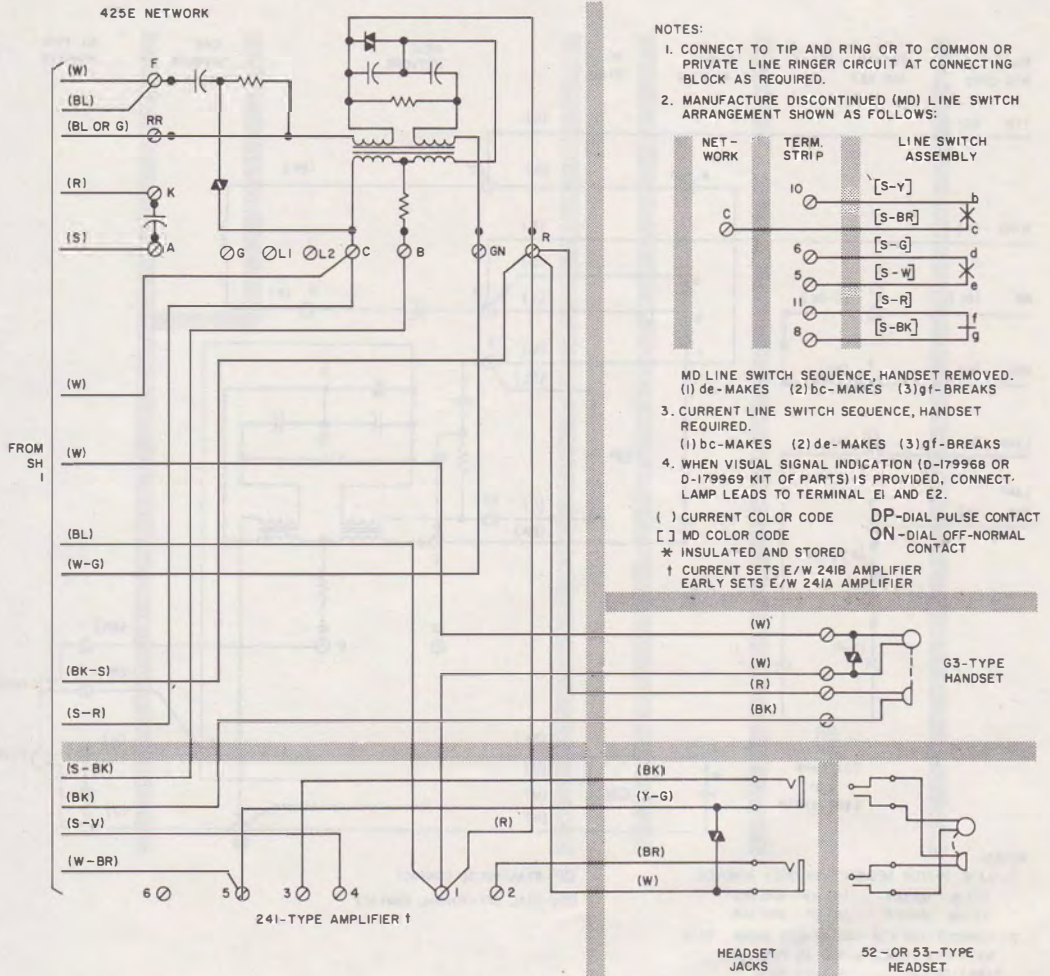
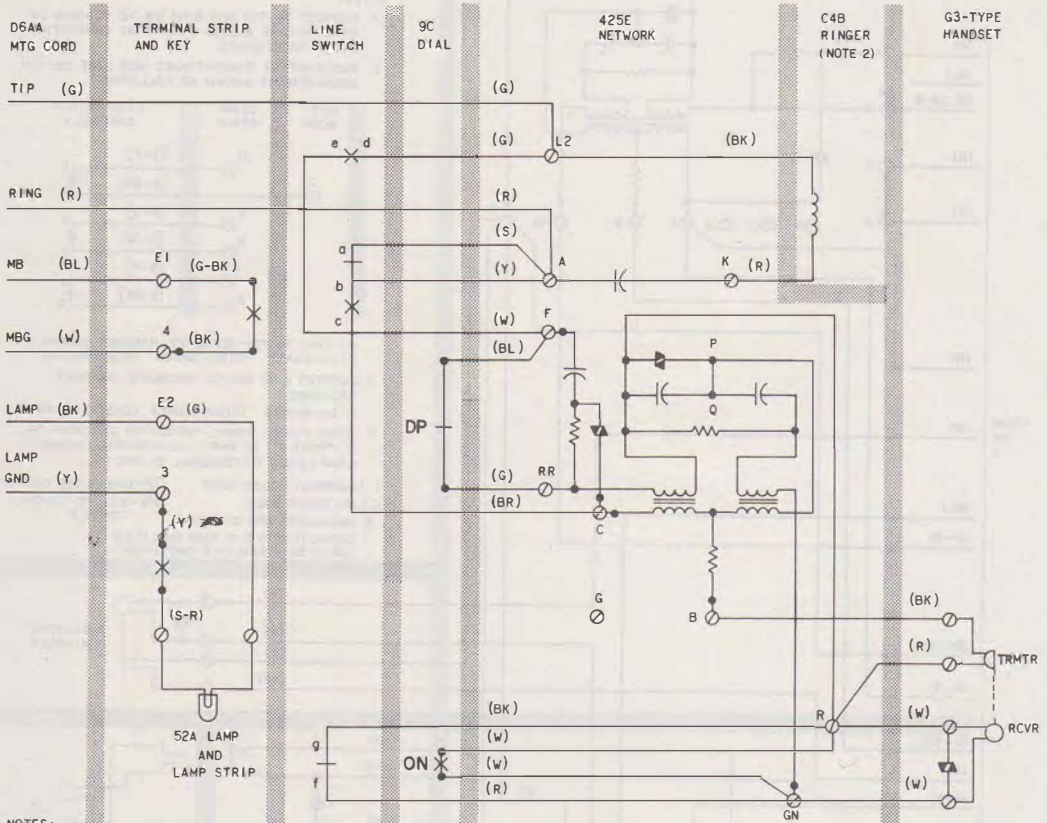

Fig. 24—514B Telephone Set, Connections (Sheet 1 of 2)

TPA 518625



◆ Fig. 24—514B Telephone Set, Connections (Sheet 2 of 2) ◆



NOTES:

1. LINE SWITCH SEQUENCE HANDSET REMOVED.
 - (1) bc - MAKES (3) ab - BREAKS
 - (2) de - MAKES (4) gf - BREAKS
2. CONNECTIONS FOR C4B RINGER SHOWN. SETS WITH C4A RINGER WIRED AS FOLLOWS:
 - (BK) TO L2 • (S-R) TO G
 - (S) TO G • (R) TO K
3. FACTORY WIRED FOR BRIDGED SERVICE.

DP-DIAL PULSE CONTACT
ON-DIAL OFF-NORMAL CONTACT

TPA 55050I

Fig. 25—516B Telephone Set, Connections