

6017-, 6026-, KS-21254, AND KS-21776 TYPE SEPARATELY MOUNTED KEYS IDENTIFICATION, INSTALLATION, AND CONNECTIONS

1. GENERAL

1.01 This section contains information on 6017, 6026, KS-21254 (MD), and ~~KS-21776~~ lever type separately mounted keys.

1.02 This section is reissued to:

- Add information on KS-21776, Lists 1 through 9 keys
- Include schematic drawings of KS-21254, Lists 1 through 4 keys.
- Show KS-21254 type keys MD, replaced by certain KS-21776 type keys, Table B
- Show 6017A, B, C, D, H, and J keys rated (A&M Only) Table A.

2. IDENTIFICATION

2.01 These keys are referred to as lever type and are used to perform general switching functions in station equipment and systems.

A. Ordering Guide

2.02 Refer to Tables A and B for ordering information.

B. Design Features

2.03 **6017-Type Key (Fig. 1):**

- Consists of a key unit and terminal strip mounted in a gray plastic housing
- Not equipped with a designation card holder. A 98A designation strip is available but must be ordered separately. Use a 804768828 (P-476882) designation card or make from good grade of paper approximately 9/16-inch by 5/16-inch.

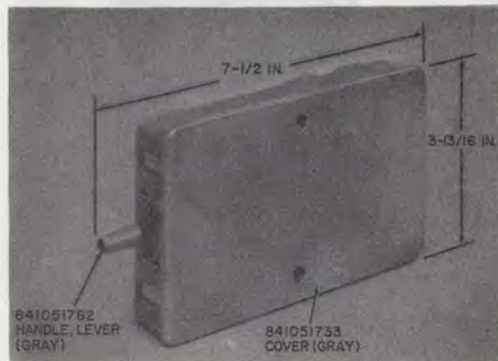

Fig. 1—6017-Type Keys

2.04 **6026-Type Key (Fig. 2):**

- Consists of a key unit, jacks for a 52- or 53-type head telephone set, and a terminal strip mounted in a black metal housing
- This type key is supplied with a designation card holder. Use a E-1164 or E-1165 designation card (cut to size).

2.05 **KS-21254 Type Key (MD) (Fig. 3, 4, 5, or 6).**

- Consists of a toggle switch (two or four pole), flexible wiring strip with 6 or 12 screw terminals for making electrical connections, and molded plastic cover held to base by serrated locking or hex nut at front (Fig. 3) and snap fit at the rear. Cover has a simplified schematic molded inside.
- Contacts are gold plated, suitable for voice and data transmission paths. Contacts also

NOTICE

Not for use or disclosure outside the
Bell System except under written agreement

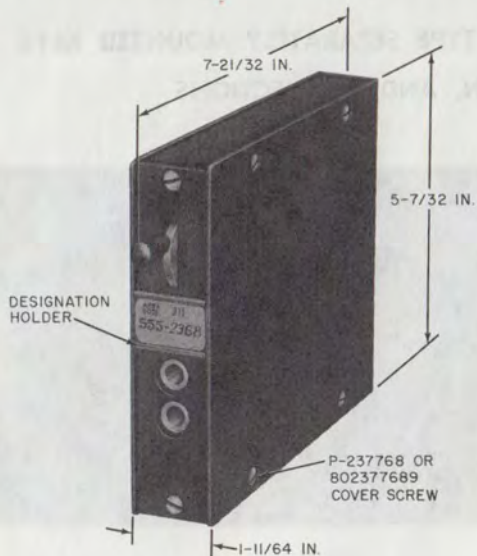

Fig. 2—6026-Type Keys

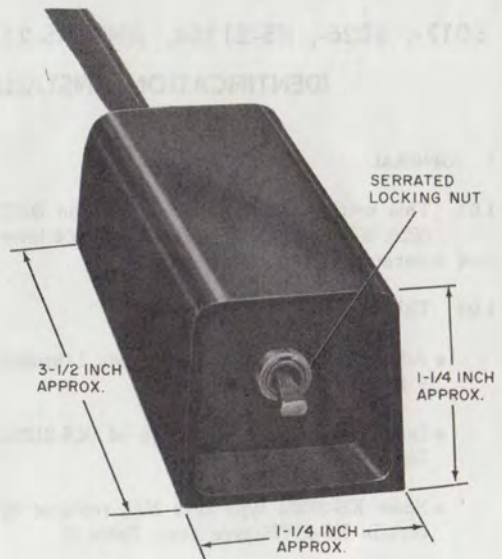

Fig. 3—KS-21254 Type Key (MD)

satisfactory for low energy level circuits associated with solid state devices.

- Electrical cord channel is provided with four teeth-like protrusions which act as a cord stay to prevent cord from being dislodged (Fig. 4)
- Will mount on 77A mounting bracket (ordered separately) so key can be attached to baseplate of telephone set (Fig. 5 and 6)
- Key can be fastened to desk, wall, etc. by appropriate hardware not furnished with key.

2.06 ♦KS-21776 Type Key (Fig. 7, 8, or 9).

- All list number keys (Table B) are available in two different types (A and B).

(a) There are two types of keys, one type (Fig. 8) consists of:

- (1) Toggle switch (two or four pole).

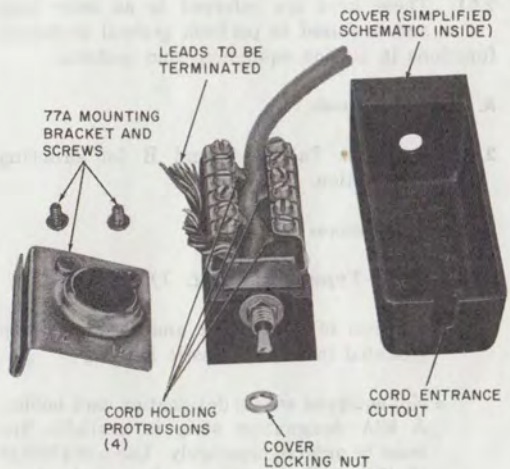

Fig. 4—KS-21254, List 4 Key (MD) Cover Removed and 77A Mounting Bracket



Fig. 5—KS-21254 Type Key (MD) Installed With 2500-Type Telephone Set



Fig. 6—Interior View of KS-21254, List 4 Key (MD) Showing Leads Terminated

- (2) Flexible wiring strip (six or twelve terminal).
- (3) Electrical cord channel is provided with four teeth-like protrusions which act as a cord stay to prevent cord from being dislodged.

Note: These keys can be mounted on 77A mounting bracket or can be fastened to desk, wall, etc. by appropriate hardware. The bracket and hardware must be ordered separately or furnished locally.

(b) The other type (Fig. 9) consists of.

- (1) Toggle switch (two or four pole).
- (2) Screw terminals (6 or 12).
- (3) Auxiliary mounting bracket.
- (4) Pan head mounting screws (2).
- (5) Double-sided adhesive tape (fastened to auxiliary mounting bracket).

Note: These keys are not intended to be mounted with the 77A mounting bracket.



All key covers must be ordered separately (Table B). A simplified schematic is provided on a stick-on decal which is furnished with each key and should be placed inside cover.

- Contacts of toggle switch on both type keys are gold plated and suitable for voice and data transmission paths. Contacts also satisfactory for low energy level circuits associated with solid state devices
- Replaces certain 6017- and KS-21254 type keys, refer to Table B.♦

3. INSTALLATION

3.01 6017- or 6026-Type Keys.

- (a) Locate key where readily accessible to user and designation strip can be seen.
- (b) Face of key should be flush with edge of desk or table. Discourage knee well installations because of space limitations and possible accident hazards.
- (c) To limit number of holes in customer's furniture, key and associated equipment may be mounted on a common backboard.
- (d) Keys are furnished for right-hand mounting on desk or table. To mount 6017-type key

on left side, remove screws holding key to box and invert key. For 6026-type key, reverse cover and back.

(e) A 14A guard (ordered separately) is available to prevent accidental operation of 6017-type keys in special service applications. Mounting screws furnished with guard. To mount 14A guard.

- (1) Unscrew key lever handle and remove.
 - (2) Remove four screws securing key to housing.
 - (3) Place guard over lever.
 - (4) Secure guard and key to housing with screws provided with guard.
 - (5) Replace key lever handle.
- (f) The 10A guard is another type designed to hold a 6017-type key in the operated or nonoperated position. The guard fits over the key lever and is held in either position by the lever handle being tightened against it. The lever handle must be unscrewed to change the lever position and then retightened. The 10A guard is used in special service applications and must be ordered separately.

3.02 ♦KS-21254 Keys MD♦

- (a) Locate key where readily accessible by attaching to telephone set using 77A mounting bracket or fasten key to desk, wall, etc. using appropriate hardware not furnished with key.
- (b) Terminate electrical connections as required. A simplified schematic of the key is shown inside the key cover (Fig. 4).



Place leads between screwhead and washer. Do not place leads between flexible wiring strip and washer. For KS-21254, Lists 1, 2, and 3 keys, use only terminals 2A, B, C and 4A,

B, C. The other terminals are not connected for these keys. For List 4 key, all terminals are connected.

3.03 ♦KS-21776 Key.

- (a) Locate the key with flexible wiring strip where readily accessible by attaching to the telephone set using 77A mounting bracket or fasten key to desk, wall, etc. by using the appropriate hardware not furnished with key.
- (b) Locate the key with screw terminals where readily accessible by attaching to the telephone set using the auxiliary mounting bracket furnished with each key and the double-sided adhesive tape attached to the mounting bracket. May be fastened to desk, wall etc. by pan head mounting screws furnished with key.

Caution: The double-sided adhesive tape should not be used to fasten the key to surfaces other than the auxiliary mounting bracket.

- (c) Terminate electrical connections as required. The stick-on schematic decal furnished with all keys should be placed inside the key cover as shown in Fig. 8.♦

4. CONNECTION INDEX

Fig. 10—6017-Type Lever Keys, Schematics

Fig. 11—6026-Type Lever Keys, Schematics

Fig. 12—KS-21254 Type Keys, Schematics

Fig. 13—KS-21776 Type Keys, Schematics

♦ TABLE A ♦

ORDERING GUIDE 6017—AND 6026—TYPE KEYS

KEY (SEE NOTE)	PRINCIPLE USE	KEY (SEE NOTE)	PRINCIPLE USE		
6017A†	Station Switching	6017Y	1A Key Private Line Circuit		
6017B†	2-Line Pickup	6017AA	Station Signal — Key Equipment 102A		
6017C†	Station Ringing Key	6017AB 6017AC 6017AK 6017AL*	General		
6017D†	4-Wire Private Line Systems				
6017E	3-Line Pickup				
6017G	Switching Key Used in No. 750A or 755A PBX				
6017H†	Signal Control — 2-Wire Line — Station and Control Circuit				
6017J†	Line Cutoff in 1A and 1A1 Key Telephone Systems	6017AM	5A Key Equipment		
6017K	5A Key Equipment With 100-Type Loudspeaker	6017AN	5B Key Equipment		
		6017AP 6017AR	Data Application — 4-Wire Line — Equipped with 14A guard-stamped LINE and TEST at front and rear lever positions, respectively.		
6017L	5B Key Equipment With 100-Type Loudspeaker			6026B	4A Key Equipment with Hold
6017M 6017P	Loudspeaker and Paging Systems	6026C	4-Wire Private Line Termination		
		6017R	750A or 755A PBX Control	6026D	4A Key Equipment (without hold, may be used with 1A, 1A1, or 1A2 Key Telephone System)
6017S 6017T 6017U	2A Key Telephone Systems				

* Contacts must be wired to terminal as required. See Fig. 3.

† (A&M Only).

Note: Early 6017- and current 6026-type keys are furnished in a black metal housing with a black handle but are available with red or white handle when specified on order. Current 6017-type key are furnished with a gray plastic cover and gray handle.

♦ TABLE B ♦

ORDERING GUIDE KS-21776 TYPE KEYS

KEY CODE (NOTES 1 AND 2)	FUNCTION	KEY LEVER POSITION			REPLACES (6017-TYPE)	REPLACES (KS-21254 TYPE)
		UP	CENTER	DOWN		
KS-21776L1	2PDT	On	None	On	6017B*	List 2
KS-21776L2	2PTT	On	Off	On	6017A*	List 1
KS-21776L3	2PDT	On	None	On†	6017C*	List 3
KS-21776L4	4PTT	On	On	On	—	—
KS-21776L5	4PDT	On	None	On	6017D*, H,* & J*	List 4
KS-21776L6	4PTT	On	Off	On	—	—
KS-21776L7	4PDT	On	None	On†	—	—
KS-21776L8	4PTT	On†	Off	On†	—	—
KS-21776L9	4PTT	On	Off	On†	—	—

* (A&M Only).

† Indicates a momentary or nonlocking position.

Note 1. Key covers must be ordered separately as follows:

Cover, KS-21776L101 with color suffix added. Black (-03), Ivory (-50), Green (-51), Red (-53), Yellow (-56), White (-58), Light Beige (-60), or Light Gray (-61).

Note 2. The base of all KS-21776 type may be black or the same color as the key cover.

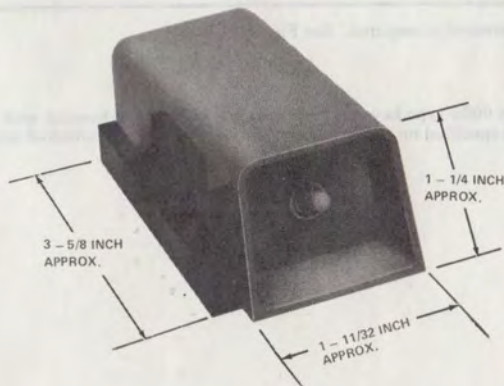

Fig. 7—KS-21776 Type Key

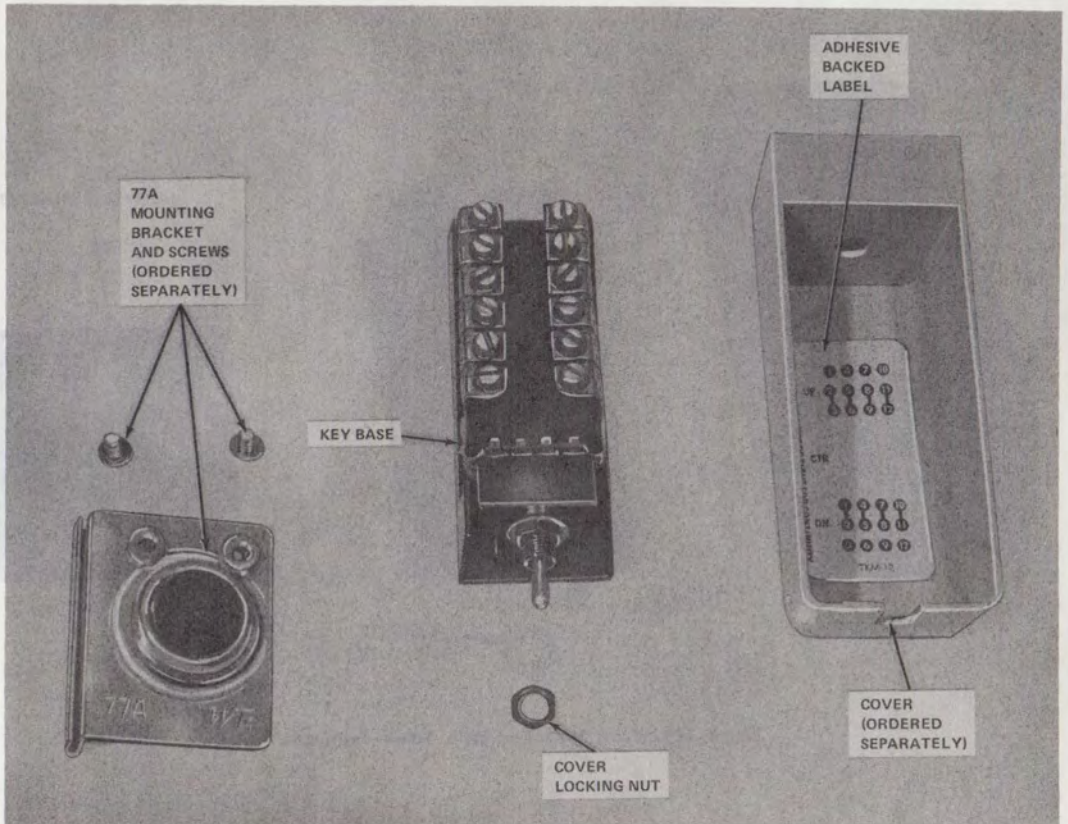

Fig. 8—KS-21776 Type Key With Flexible Wiring Strip

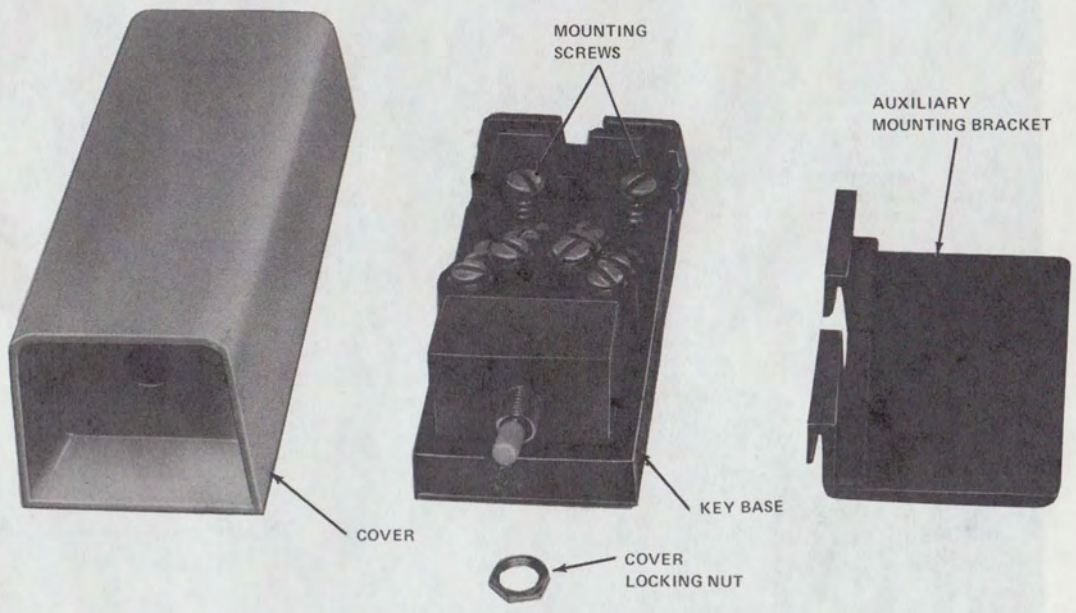

Fig. 9—KS-21776 Type Key With Screw Terminals

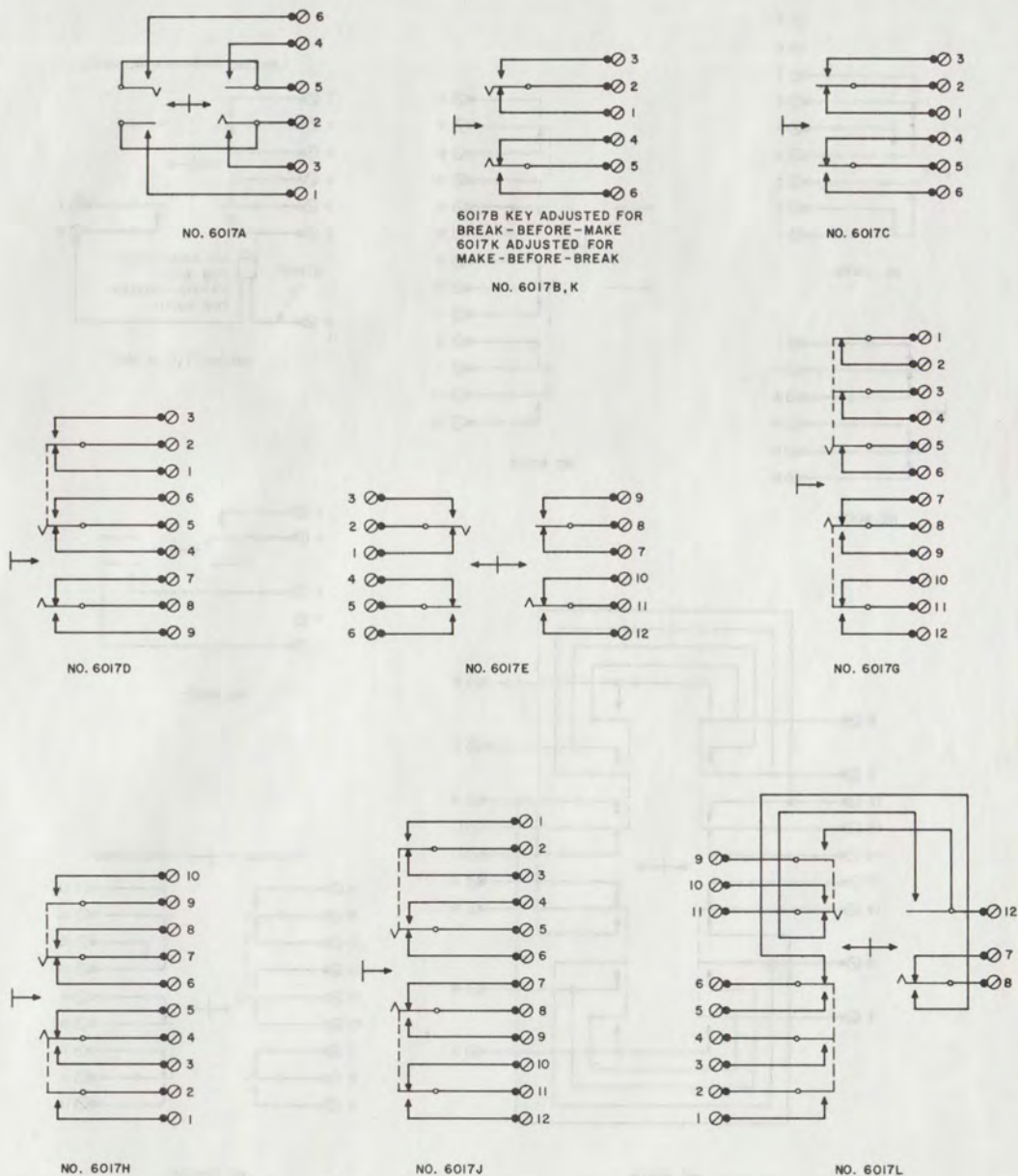
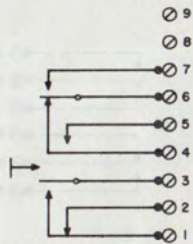
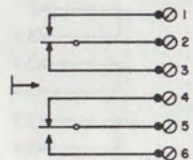

Fig. 10—6017-Type Keys, Schematics (Sheet 1 of 4)



NO. 6017M



NO. 6017P

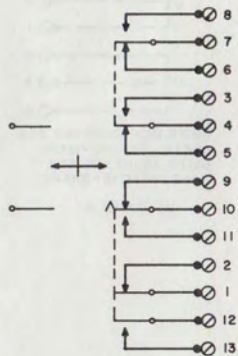

NO. 6017S

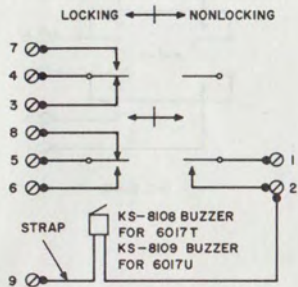

NO. 6017T, U, W (MD)

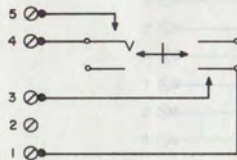

NO. 6017Y

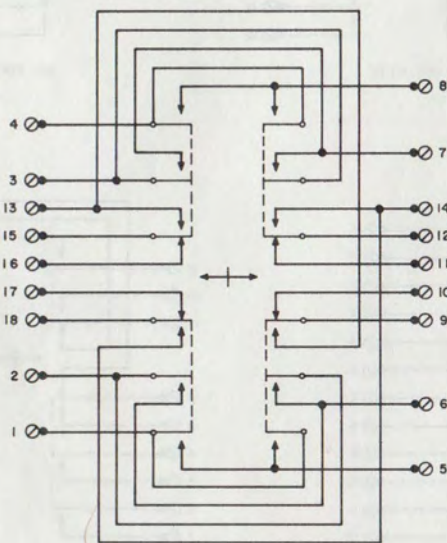

NO. 6017R

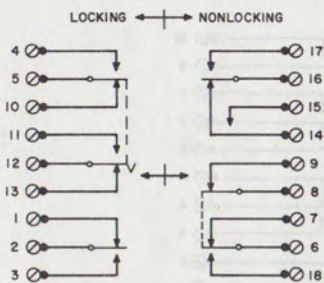

NO. 6017AK

Fig. 10—6017-Type Keys, Schematics (Sheet 2 of 4)

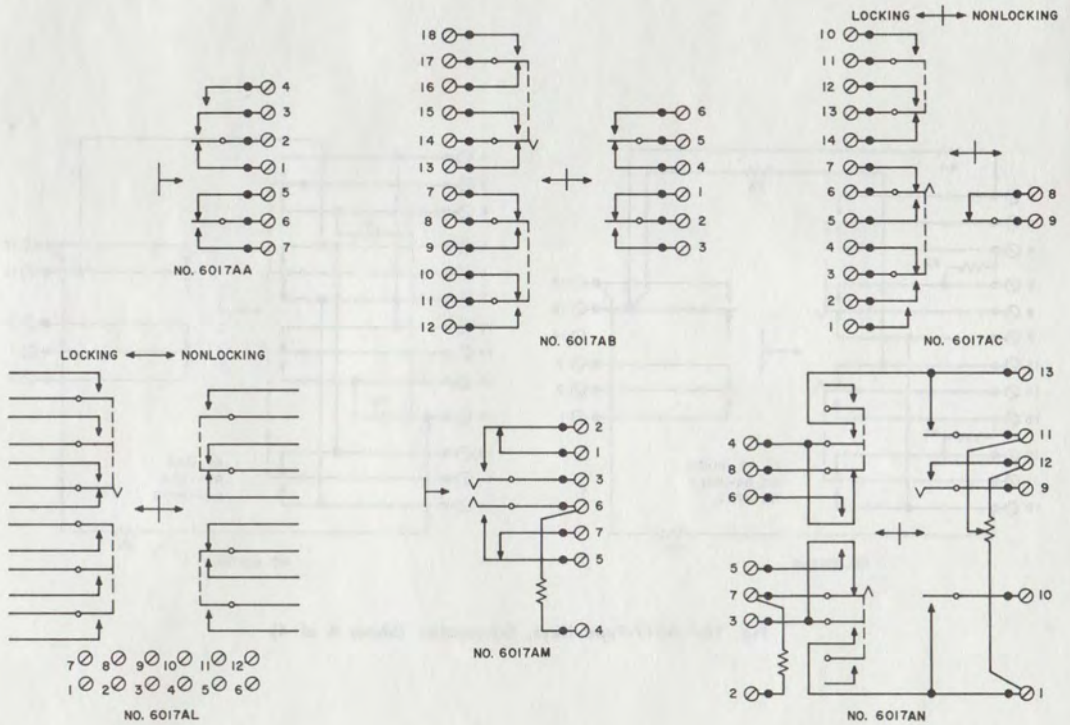

Fig. 10—6017-Type Keys, Schematics (Sheet 3 or 4)

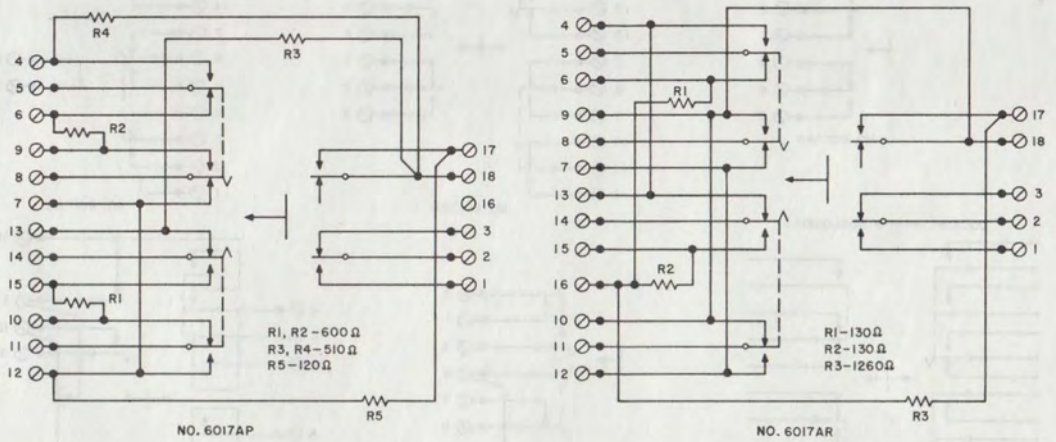

Fig. 10—6017-Type Keys, Schematics (Sheet 4 of 4)

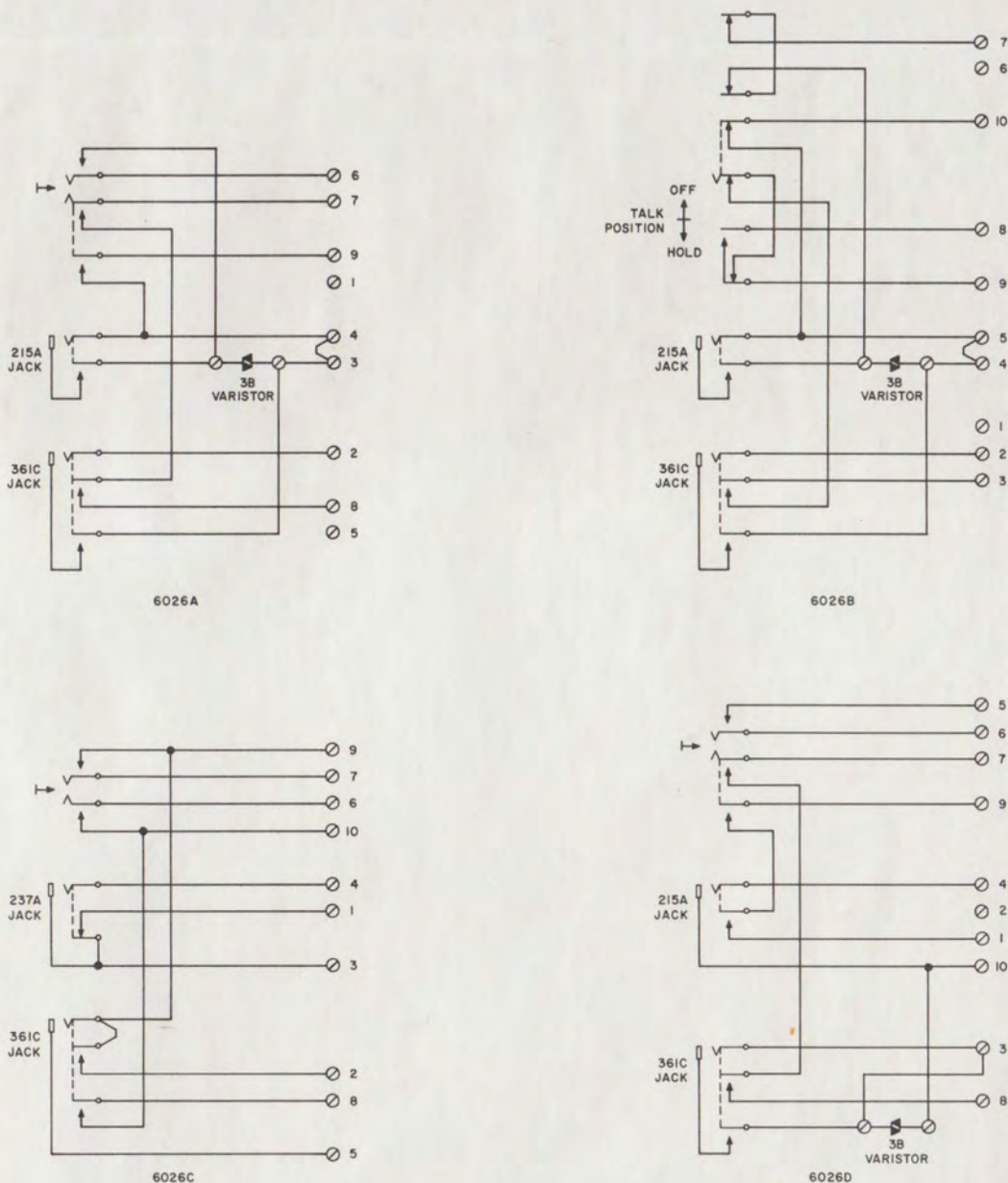

Fig. 11—6026-Type Keys, Schematic

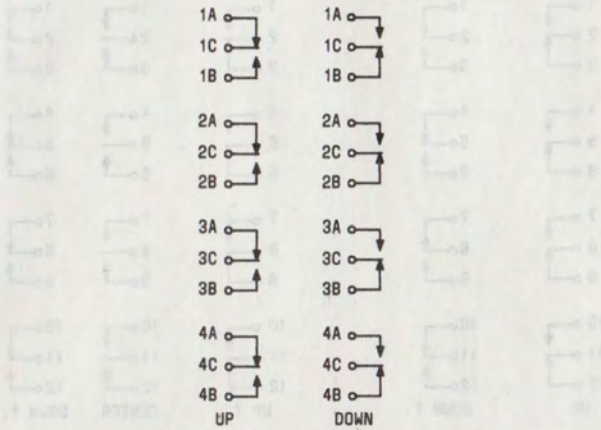
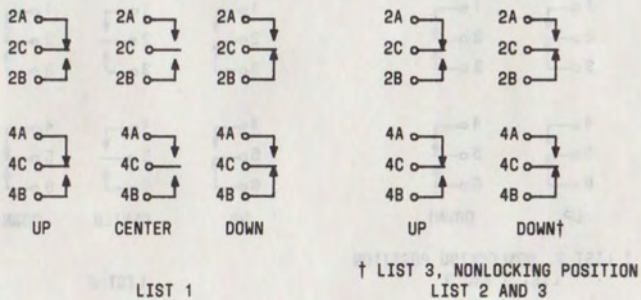
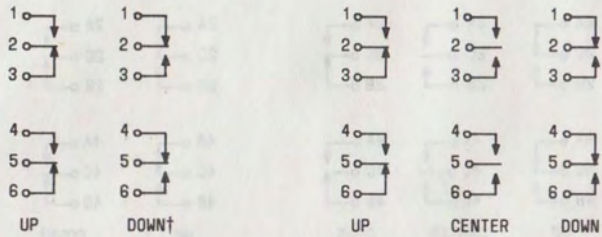
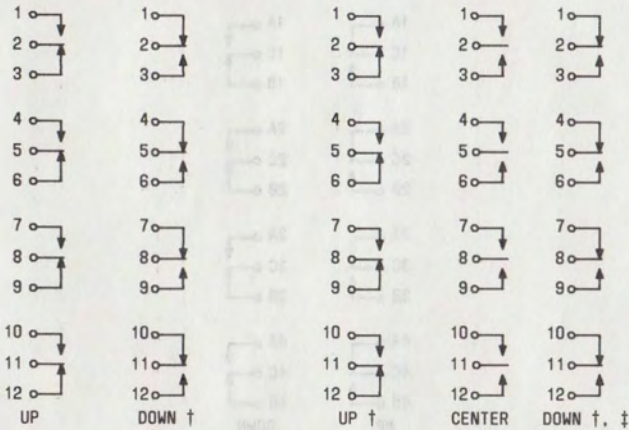

Fig. 12—KS-21254 Type Keys (MD), Schematic



† LIST 3, NONLOCKING POSITION
LIST 1 AND 3

LIST 2



† LIST 5, NONLOCKING POSITION
LIST 5 AND 7

† LIST 8, NONLOCKING POSITION
‡ LIST 9, NONLOCKING POSITION
LIST 6, 8, AND 9

Fig. 13—KS-21776 Type Keys, Schematics (Sheet 1 of 2)

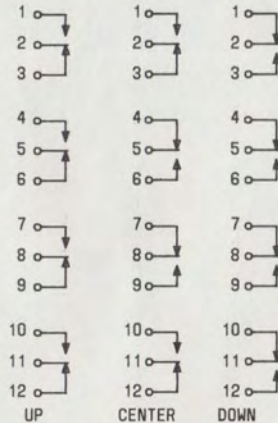

LIST 4

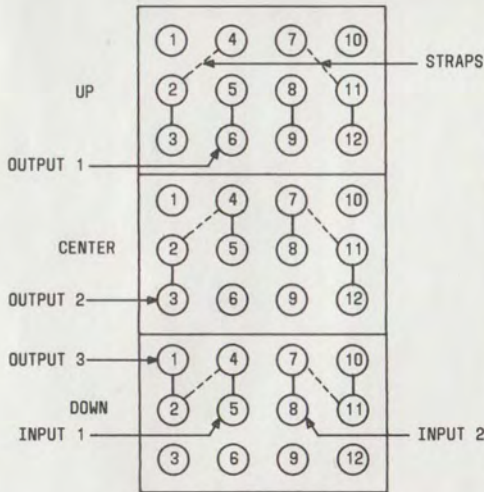

LIST 4
(SEE NOTE 1)

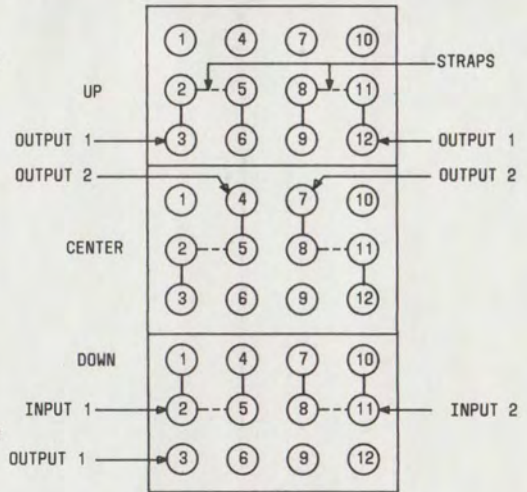

LIST 4
(SEE NOTE 2)

NOTES:

1. LIST 4 MAY BE CONVERTED TO A TWO POLE SWITCH WITH EACH POLE HAVING ONE INPUT AND THREE OUTPUTS BY ADDING TWO STRAPS AS SHOWN.
2. LIST 4 MAY BE CONVERTED TO A TWO POLE DOUBLE THROW MAKE-BEFORE-BREAK SWITCH BY THE ADDITION OF TWO STRAPS AS SHOWN. TERMINALS 6 & 9 ARE NOT USED.

Fig. 13—KS-21776 Type Keys, Schematics (Sheet 2 of 2)