

511- AND 2511-TYPE TELEPHONE SETS

CONNECTIONS

SPEAKERPHONE SYSTEM—4A

1. GENERAL

1.01 This section contains information for the 511- and 2511-type telephone sets used with the 4A speakerphone system.

1.02 The reasons for reissuing this section are listed below. Revision arrows are used to emphasize the more significant changes.

- Identify registered arrangements
- Revise Fig. 2.

1.03 Refer to Section 512-700-100 for detailed information on the components of the 4A speakerphone system.

1.04 To provide 4A speakerphone feature for these telephone sets, refer to Fig. 1, 2, and 3 for layout arrangement of the components required, and Fig. 4 through 9 for individual connections.

1.05 The 511D (MD) telephone set is factory-wired for non-KTS use (Fig. 4). The 511F (MD), 511H (MD), 511HM, 2511F (MD), 2511H (MD), and 2511HM telephone sets are factory-wired for use with 1A1 or 1A2 KTS (Fig. 5, 6, and 7).

1.06 The 511HM and 2511HM telephone sets are registered for connection to CO lines in the arrangements shown in Fig. 3 and 9 only.

2. CONNECTIONS

A. 223-Type Adapter

2.01 The cords from the 108-type loudspeaker set, 680-type transmitter, and 85B1 power unit are installed in the proper receptacle of the 223A (MD) or 223D adapter. The cover must be fastened securely to assure proper mating of connectors.

B. 108-Type Loudspeaker Set

2.02 The loudspeaker set and transmitter must be placed a minimum of one foot apart.

C. 680-Type Transmitter

2.03 The transmitter must be at least two feet from transformer or any ac powered device.

D. 85B1 Power Unit

Danger: For safety, securely attach a retaining clamp to ac outlet using outlet cover screw before attempting to install 85B1 power unit. When removing 85B1 power unit, always unplug the power unit completely from the outlet before attempting to remove the retaining clamp. This will prevent the possibility of a loosened retainer clamp or metallic outlet cover making contact with the ac prongs of the 85B1 power unit when partially withdrawn from outlet. Do not use retaining clamp on outlets where the cover mounting screw holds the duplex outlet in the box.

Warning: Care should be taken to trim and dress leads connecting to low voltage output terminals of 85B1 power unit to assure that inadvertent connection to conducting surfaces or other power sources do not occur. If more than one power unit is plugged into a multiple receptacle power strip, there must be at least one inch separation between power units. Only UL listed receptacle power strips with adequate power rating shall be used. Use of a continuous terminal power strip that allows the secondary output terminals of the power unit to be

NOTICE

Not for use or disclosure outside the
Bell System except under written agreement

in close proximity to the ac line source is not recommended.

2.04 Power shall be supplied by connecting 85B1 power unit as shown in Fig. 1, 2, 3, 4, 8, and 9.

2.05 Use an ac power outlet (not under control of a switch) located as close as possible to the system being installed. A retaining clamp will be shipped with the power unit and should be mounted

to the ac receptacle to hold power unit securely to prevent accidental loss of power.

2.06 The M2FG cord is furnished as part of the 223-type adapter for connecting the 85B1 power unit.

2.07 The 85B1 power unit should be located less than 125 feet from 108-type loudspeaker set when using 24 gauge wire or less than 85 feet when using 26 gauge wire. Refer to Section 512-700-100 for detailed information on power supply application.

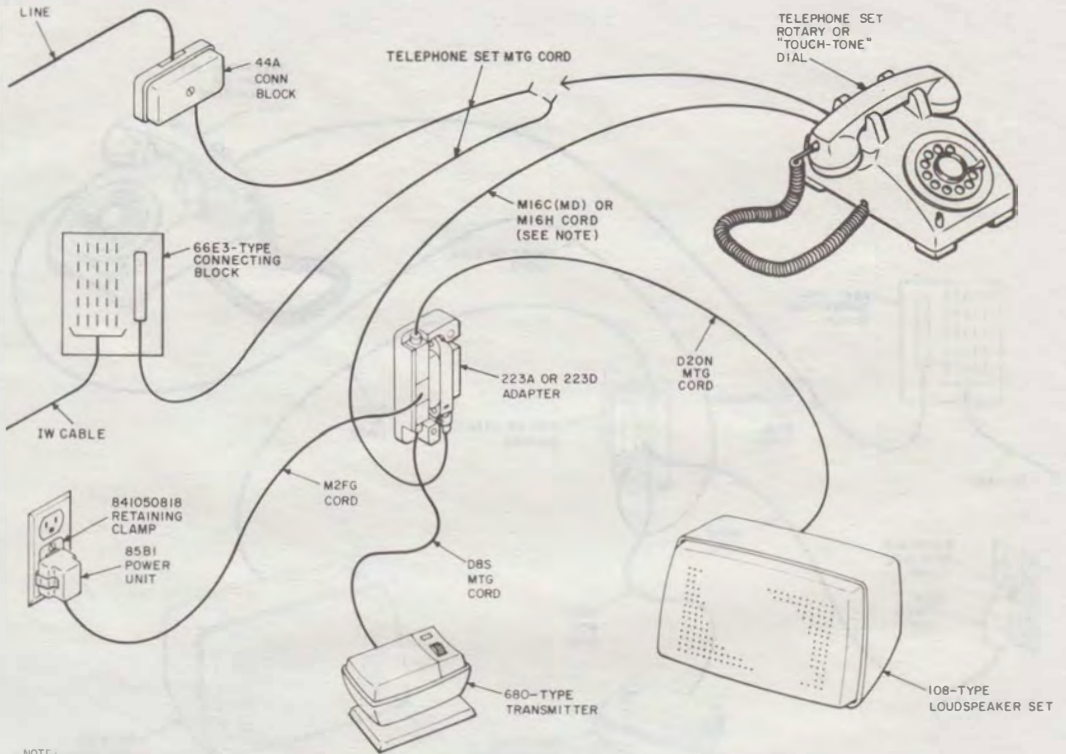

NOTE:

WHEN M16C (MD) OR M16H CORD IS TERMINATED IN SET, DISCONNECT, INSULATE, AND STORE ALL SPEAKERPHONE LEADS IN TELEPHONE SET MOUNTING CORD AT SET. WHEN M16C OR M16H CORD IS TERMINATED AT 66E3-TYPE CONNECTING BLOCK, DISCONNECT, INSULATE, AND STORE ALL SPEAKERPHONE LEADS IN THE 1W CABLE. CONNECT M16C OR M16H CORD TO CONNECTING BLOCK USING 16A ADAPTERS.

Fig. 1—Typical Grandfathered 4A Speakerphone System Arrangement, 511- and 2511-Type (Nonmodular) Telephone Set Using 223A (MD) or 223D Adapter

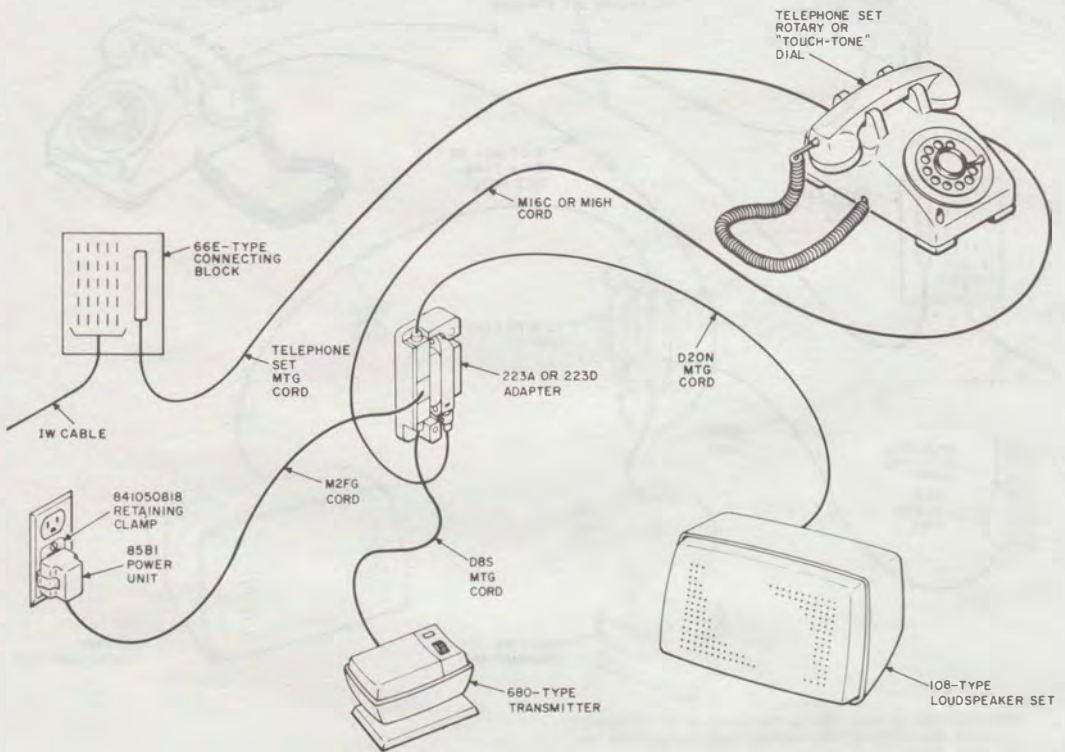

Fig. 2—Typical Grandfathered 4A Speakerphone System Arrangement, 511HM and 2511HM Telephone Set Using 223A (MD) or 223D Adapter

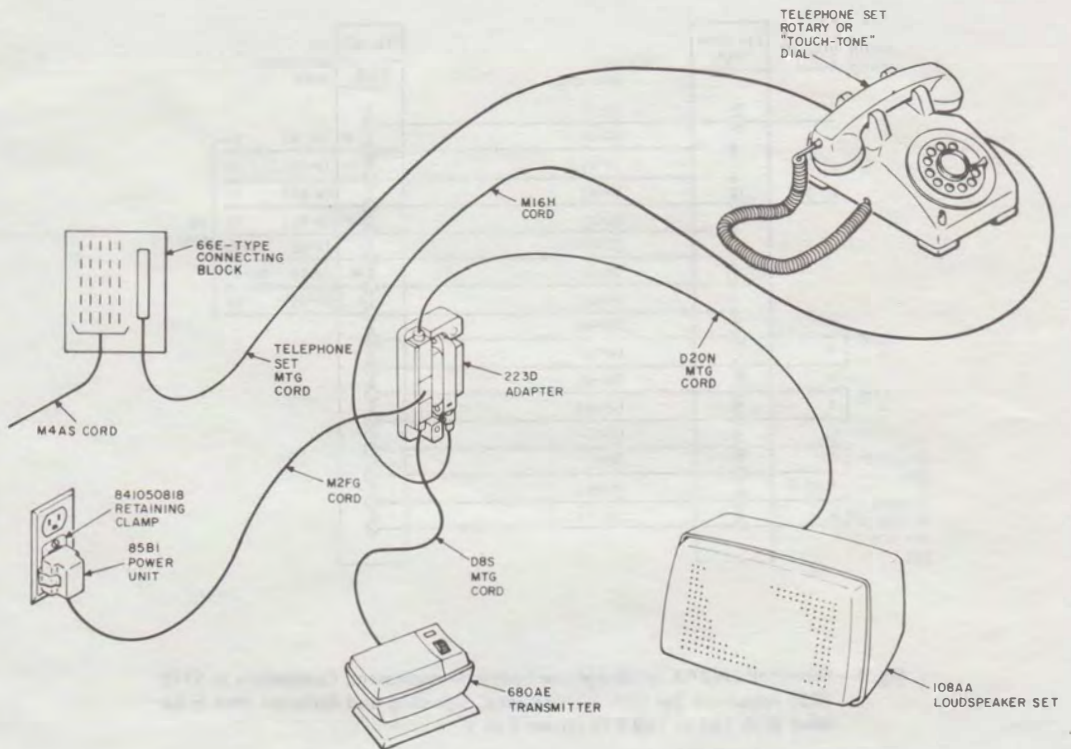

Fig. 3—Registered 4A Speakerphone System Arrangement, 511HM and 2511HM Telephone Set Using 223D Adapter

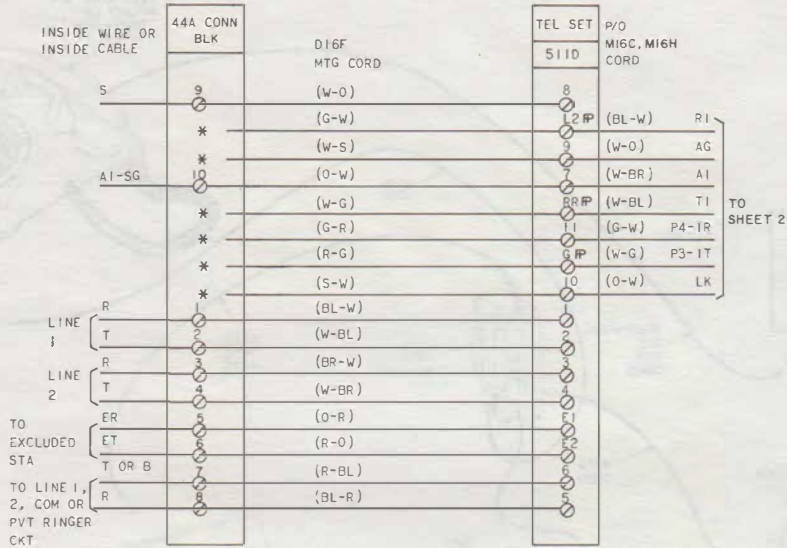

Fig. 4—Grandfathered 4A Speakerphone System Arrangement, Connections to 511D (MD) Telephone Set With 2-Line Pickup, Signaling and Exclusion (Not to be Used With 1A1 or 1A2 KTS (Sheet 1 of 2))

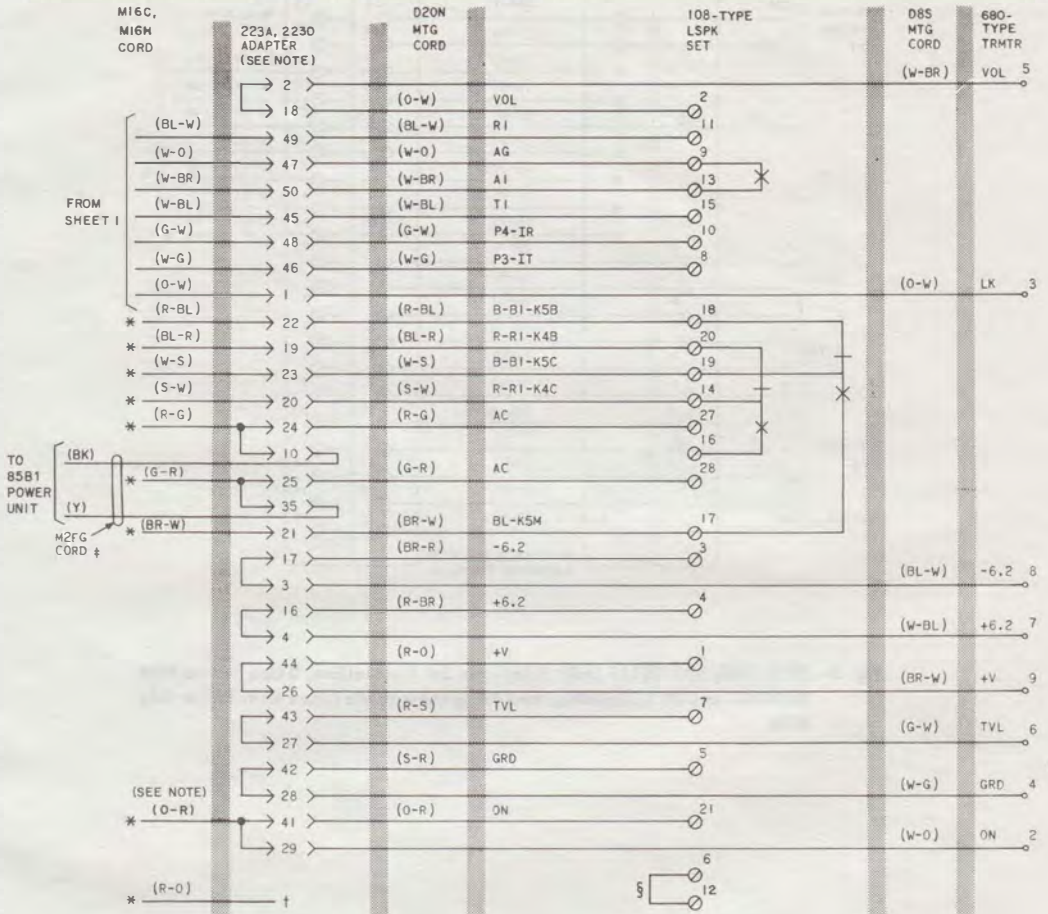

Fig. 4—Grandfathered 4A Speakerphone System Arrangement, Connections to 511D (MD) Telephone Set With 2-Line Pickup, Signaling and Exclusion (Not to be Used With 1A1 or 1A2 KTS) (Sheet 2 of 2)

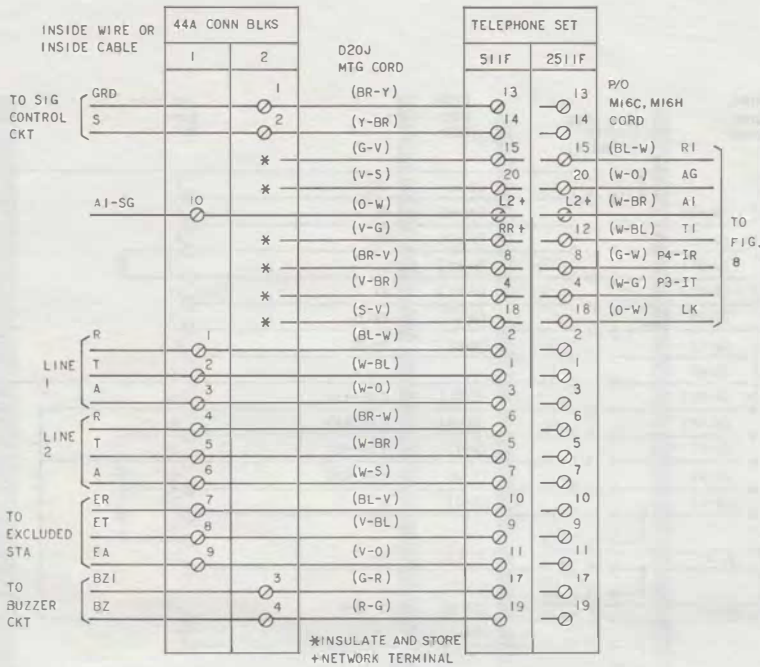

Fig. 5—511F (MD) and 2511F (MD) Telephone Set Connections, 2-Line Pickup With Exclusion on Line 1, Signaling, and 4A Speakerphone (Used With 1A1 or 1A2 KTS)

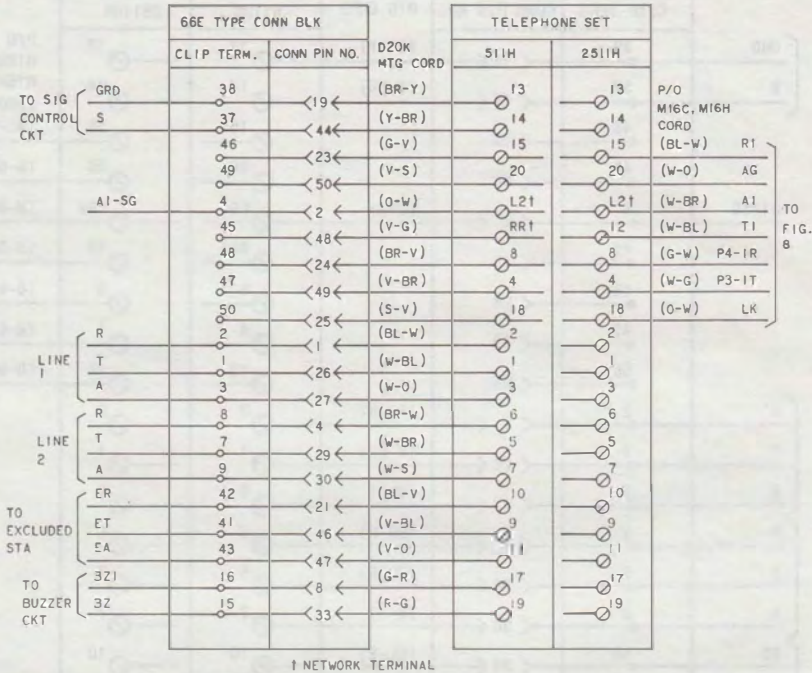
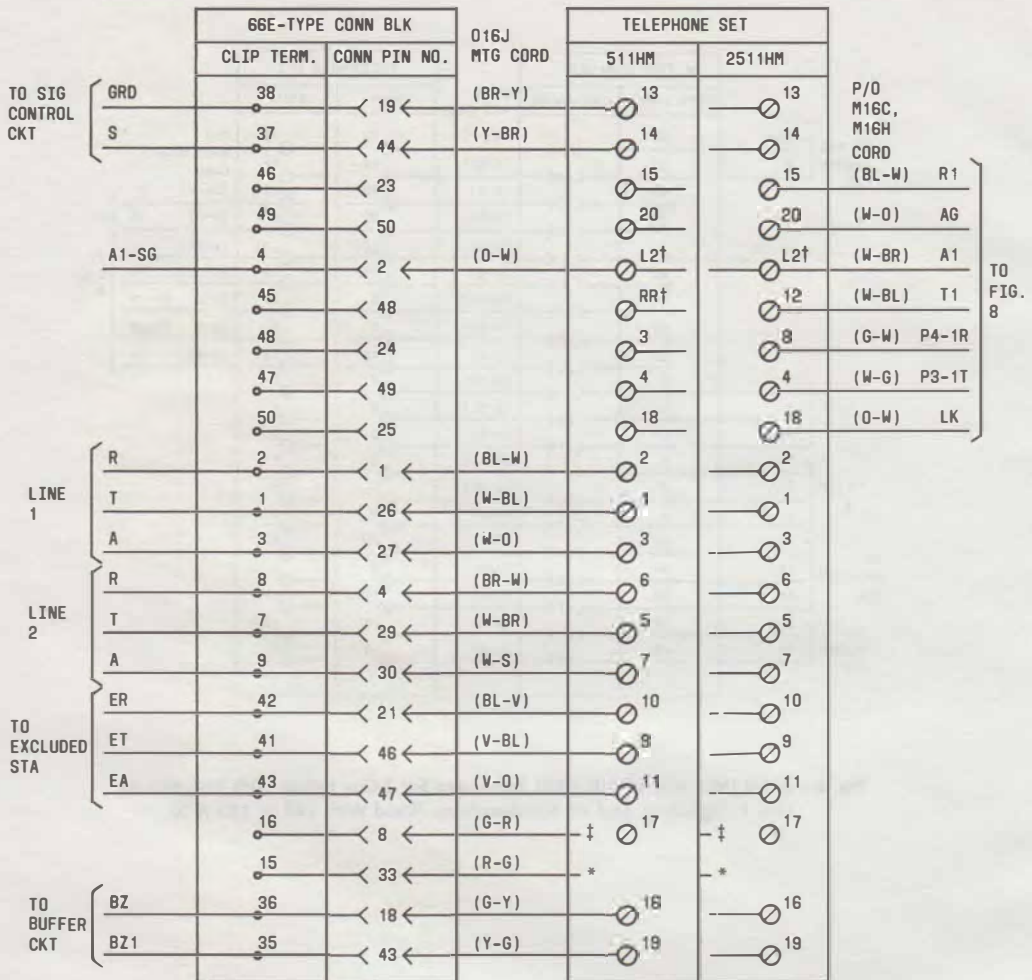

Fig. 6—511H (MD) and 2511H (MD) Telephone Set 2-Line Pickup With Exclusion on Line 1, Signaling, and 4A Speakerphone (Used With 1A2 or 1A2 KTS)



* INSULATE AND STORE

† NETWORK TERMINAL

‡ INSULATED AND STORED IN SET. CONNECT TO TERMINAL NO. 17 WHEN SET IS USED WITH 1A KTS.

Fig. 7—511HM and 2511HM Telephone Set Connections, 2-Line Pickup With Exclusion on Line 1, Signaling and 4A Speakerphone (Used With 1A1 or 1A2 KTS)

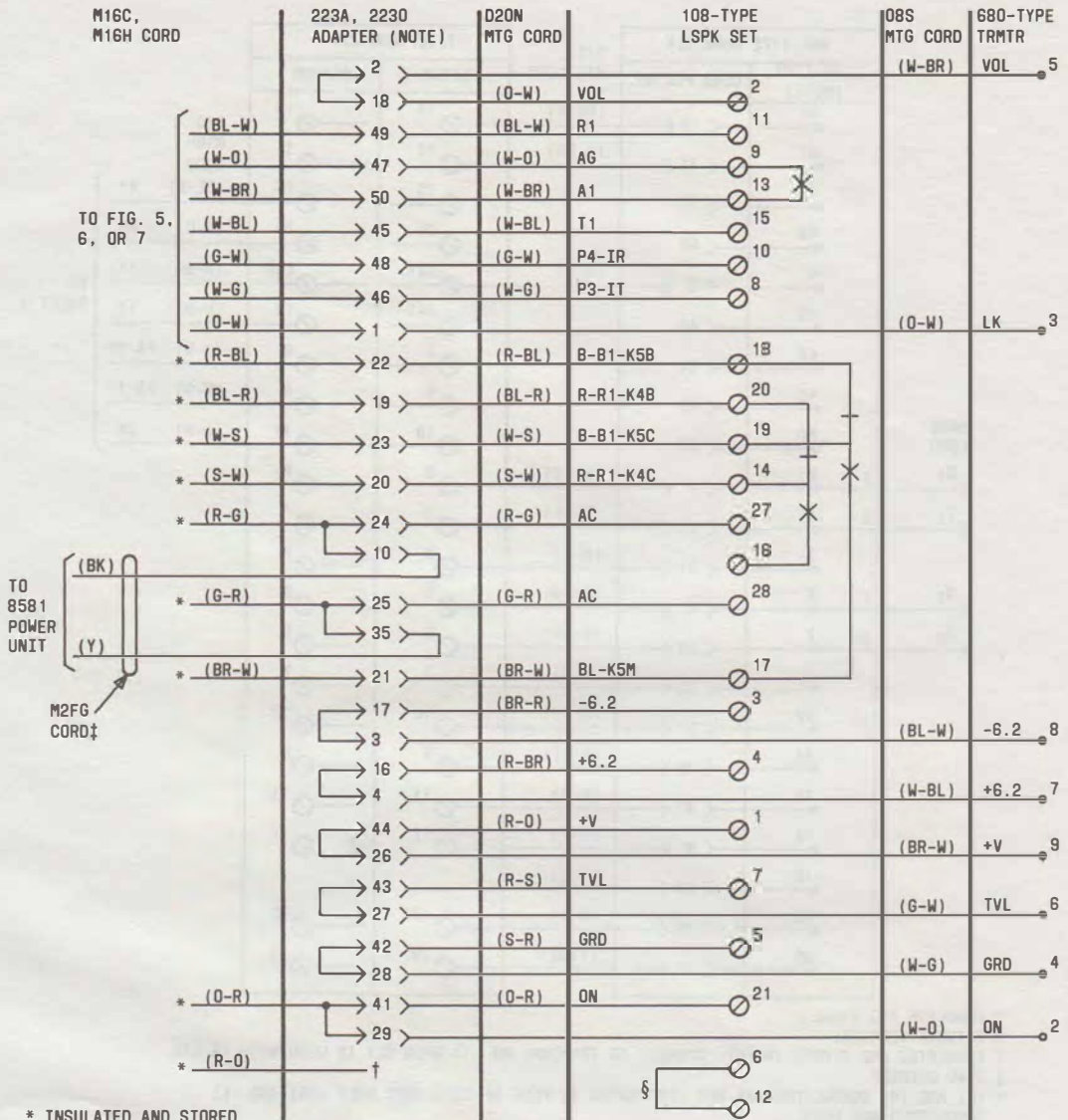

* INSULATED AND STORED
 † DEAD DRESSED
 ‡ (R) AND (G) CONDUCTORS ARE NOT TERMINATED IN PLUG OF M2FG CORD. ONLY (BK) AND (Y) CONDUCTORS ARE USED
 § STRAP APPEARS ON 108AA ONLY

NOTE: (O-R) LEAD IS DEAD DRESSED IN PLUG OF 223A ADAPTER

Fig. 8—4A Speakerphone Connections Using 223A (MD) or 223D Adapter

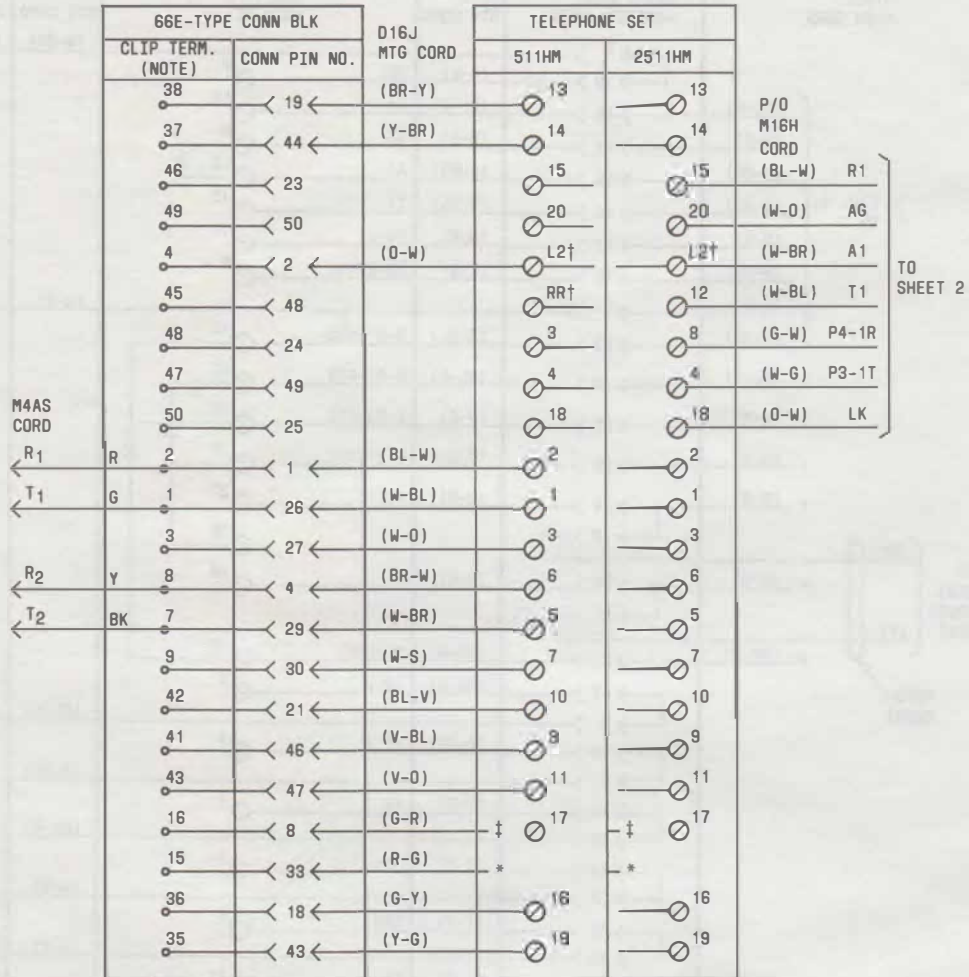

* INSULATE AND STORE

† NETWORK TERMINAL

‡ INSULATED AND STORED IN SET. CONNECT TO TERMINAL NO. 17 WHEN SET IS USED WITH 1A KTS.

§ DEAD DRESSED

¶ (R) AND (G) CONDUCTORS ARE NOT TERMINATED IN PLUG OF M2FG CORD ONLY (BK) AND (Y) CONDUCTORS ARE USED.

NOTE:

USE 161A ADAPTERS TO CONNECT TERMINALS OF M4AS CORD TO TERMINALS OF 66E-TYPE CONNECTING BLOCK.

Fig. 9—Registered 4A Speakerphone System Arrangement, Connections to 511HM and 2511HM Telephone Sets (Sheet 1 of 2)

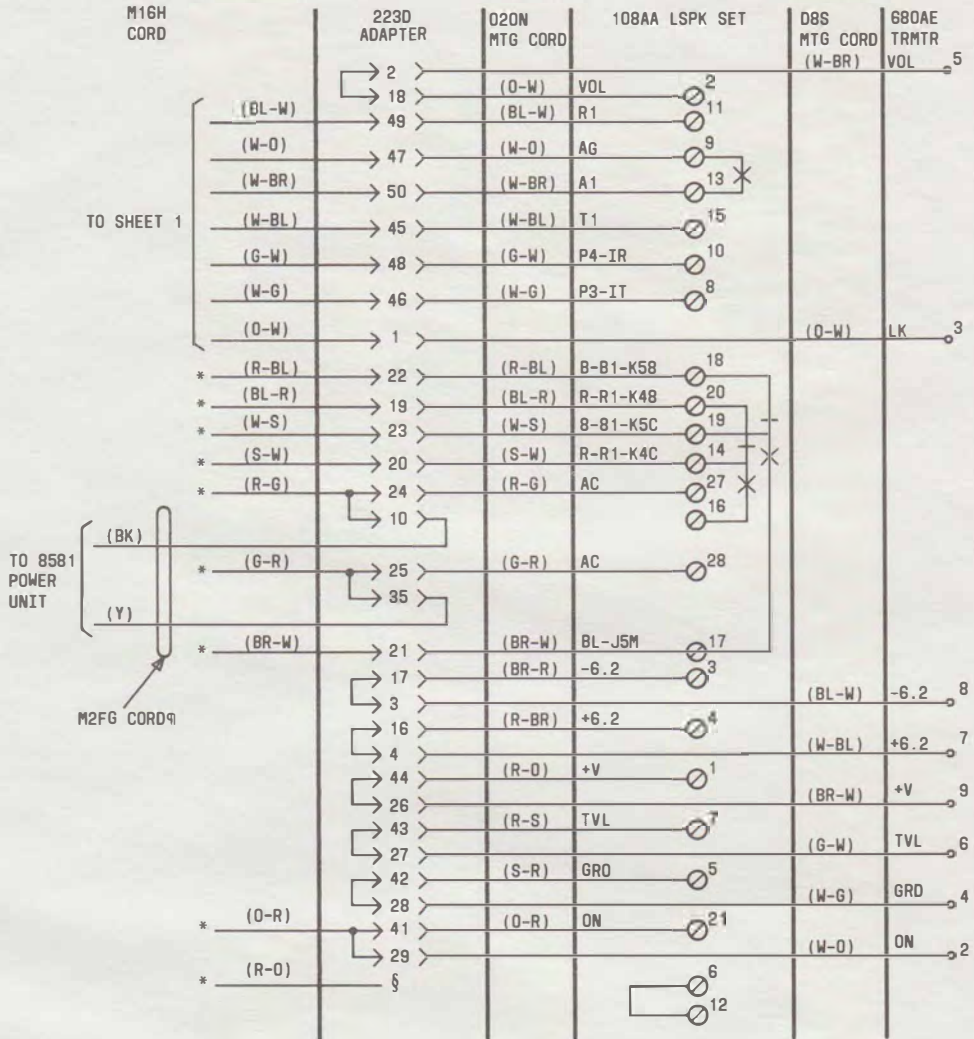

Fig. 9—Registered 4A Speakerphone System Arrangement, Connections to 511HM and 2511HM Telephone Sets (Sheet 2 of 2)