

REFERENCE

BUZZERS AND BELLS

IDENTIFICATION, INSTALLATION, MAINTENANCE, LIMITATIONS, AND CONNECTIONS

1. GENERAL

1.01 This section contains information on low voltage buzzers and bells used in ac or dc signaling circuits and high resistance buzzers that may be used on ac ringing current circuits.

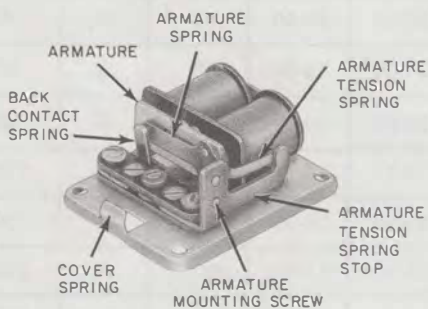

Fig. 1—7F Buzzer

1.02 This section is reissued to show intended use of 9B and 9C buzzers and revise Table B.

1.03 The 4-type buzzers are rated MD and are replaced by the 9- or KS-type buzzers.

1.04 The 7-type buzzers, except for 7F, are rated MD and are replaced by the KS-type buzzers.

2. IDENTIFICATION

A. Purpose

2.01 To provide low voltage audible signals for stations or key systems.

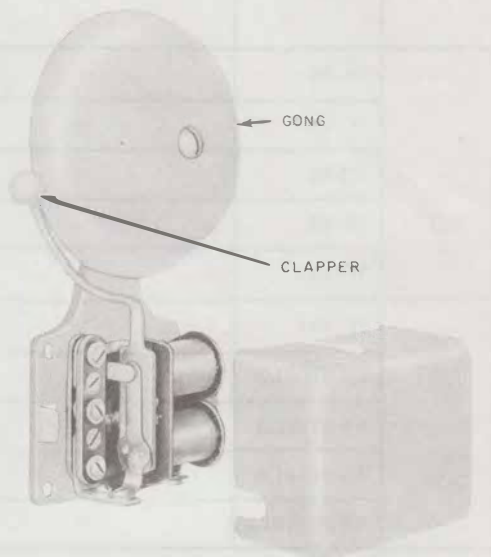

Fig. 2—7-Type Bell

B. Ordering Guide

2.02 Refer to Table A for low voltage buzzers and bells.

2.03 Refer to Table B for high resistance buzzers (ac operation only).

C. Design Features

2.04 The 7F buzzer (A&M Only) (Fig. 1) and the 7-type bell (Fig. 2) have the same design features except the bell is equipped with a clapper and 3-inch gong.

NOTICE

Not for use or disclosure outside the
Bell System except under written agreement

TABLE A

LOW VOLTAGE AC AND DC SIGNALS

ORDERING GUIDE			OPERATING FEATURES				
SIGNAL	CODE	REPLACED BY	VOLTAGE RANGE (SEE NOTE)		APPROX DC RES*	APPROXIMATE AC CURRENT IN MA	
			DC (VOLTS)	50-60 CYCLES AC		MIN	MAX
Bell	7A-49	—	14-40	25-50	270	32	75
	7C-49	—	2-5	4-9	2.6	135	200
	7D-49	—	3-10	6-18	15.8	80	185
	7E-49	—	10-20	18-30	105	85	125
	7F-49†	—	24-60	35-60	682	26	50
Buzzer	7F-49†	—	20-60	20-60	682	15	40
	KS-8108L2	—	3-4	3-4	.5	540	770
	KS-8109L2	—	14-30	14-30	55	150	400
	KS-8110L2	—	24-50	24-50	300	45	125
	KS-20419L1	—	—	6-10	60	70	125

* Multiply these values by 3 when computing dc current drain, except for 7F buzzer or bell.

† May also be operated with 16- to 20-cycle ringing current. Effective impedance is then 850 ohms and approximately 3500 ohms in series with 2- μ f capacitor.

Note: In compliance with Part 68 of the FCC rules, hazardous voltages shall not be routed through the same cables, connectors, or mounting cords as those containing the ring and tip pair or auxiliary interface leads. Accordingly when hazardous voltages used to power these devices, route power through a separate pair. (Hazardous voltages are defined as those which exceed 42 volts ac peak (30V RMS), 80 volts dc, or combined ac and dc voltages with the dc component between 21 and 80 volts, ac voltages less than (55-0.6XVdc) peak. Voltages used for network signaling and control (ringing, talk battery, etc.) are not classified as hazardous voltages.

2.05 The armature and contacts of the 7F buzzer and 7-type bell are protected by a snap-on cover. With this cover installed, the signaling unit protrudes 1-1/2 inches from the mounting surface.

2.06 The 7F buzzer and 7-type bell have three screw type terminals designated A, C, and D for conductor terminations.

2.07 The gong of the 7-type bell (Fig. 2) has its mounting hole drilled off-center. The eccentricity of the mounted gong provides for adjustment of the bell's volume by rotating the gong to increase or decrease the travel distance between the clapper and the gong.

2.08 The 9-type buzzer (Fig. 3, 4, and 5) is composed of a G1C ringer motor, P-type armature, and 64A plastic gong (cover).

◆ TABLE B ◆

HIGH RESISTANCE BUZZERS

ORDERING GUIDE	OPERATING VOLTAGE	
	24 VOLT DC	AC RINGING CURRENT
9A		•
9B*		•
9C†		•
KS-8109L2 or KS-8110L2	•	•

* Consists of 9A buzzer plus 219B adapter and mounting screws (Fig. 4). This buzzer for ac operation only.

† Consists of 9A buzzer plus 220A adapter and mounting screws (Fig. 5).

2.09 The KS-8108L1, KS-8109L1, and KS-8110L1 buzzers have either a single or double coil and should be used for dc operation only. They are rated MD.

2.10 The KS-8108L2, KS-8109L2, and KS-8110L2 buzzers (Fig. 6) replace the List 1 buzzers. They have a single coil only and may be used for ac or dc operation (Fig. 24). With dc operation, the Lists 1 and 2 buzzers are interchangeable.

2.11 The volume on KS-8108, KS-8109, and KS-8110 type buzzers can be set with the adjusting screw (Fig. 6).

2.12 The miniature KS-20419L1 buzzer (Fig. 7) is 3/4-inch in diameter, 1/2-inch thick, and is equipped with two spade-tipped leads 7-1/2 inches long.

2.13 The KS-20419L1 buzzer has a mounting bracket secured to the buzzer housing. The bracket is slotted and 1-1/4 inches in length and can be attached to a single screw at suitable location inside the telephone set.



The screw in the center of the buzzer is not intended for volume adjustment.

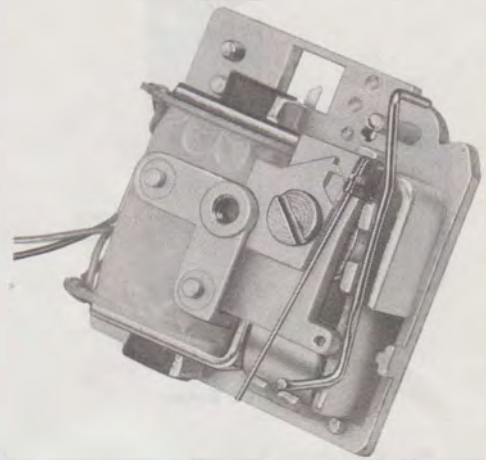

Fig. 3—9A Buzzer With Cover (64A Gong) Removed

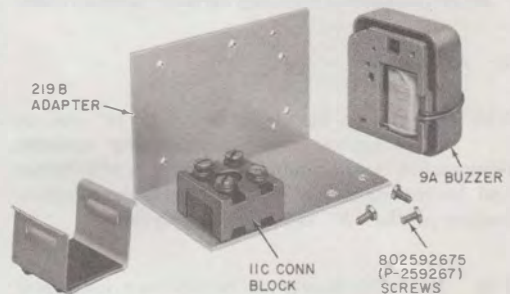

Fig. 4—9B Buzzer

2.14 The KS-13783L1 (MD) bell has been manufactured in two different models.

(a) Earlier models have a square base with a groove which permitted entry of exposed wiring.

(b) Later models have a round base with a groove for entry of exposed wiring.

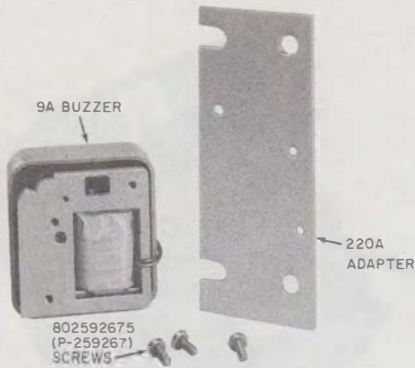

Fig. 5—9C Buzzer

- (c) The KS-13783L1 bell has a 4-inch gong and the KS-13783L2 bell has a 6-inch gong.
- (d) The KS-13783L1 and L2 bell are rated MD and are replaced by KS-16301L20 and KS-20375L1 signals. For information on the KS-16301L20 and KS-20375L1, refer to Divison 463 section entitled Auxiliary Signals—Identification.

D. Application

2.15 The 7-type buzzer or bell may be used on 6A selective intercommunicating systems, common line intercommunicating system with button and buzzer signaling, or dial intercommunicating feature of the 1A2 key telephone system.

2.16 The 9-type buzzer can be used as a distinctive common signal for central office or PBX stations working behind key equipment.



Except for 9-type buzzers, none of the bells or buzzers are to be connected directly across tip and ring leads.

E. Operating Features

2.17 When using a 7F buzzer, make dc connections to terminals D and C and ac connections to terminals A and C. When using a 7-type bell,

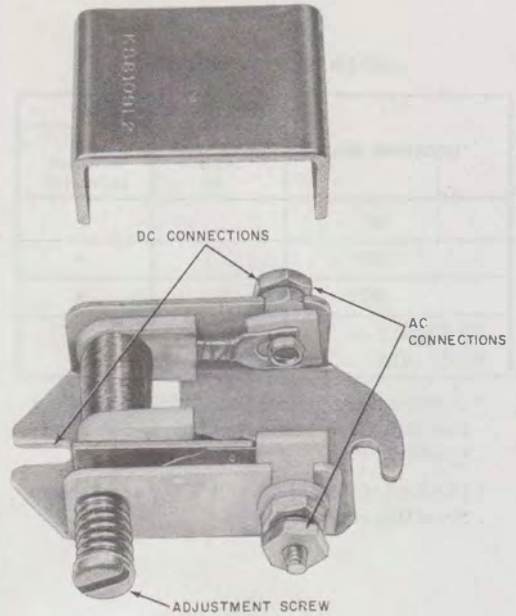

Fig. 6—KS-8109L2 Buzzer

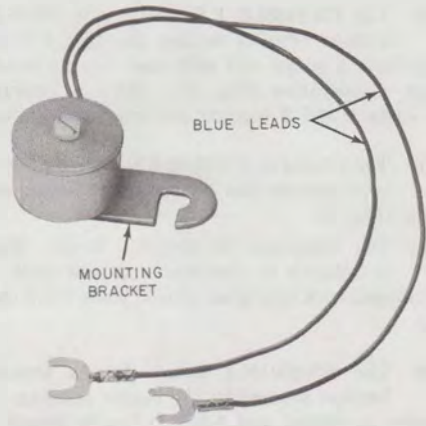

Fig. 7—KS-20419L1 Buzzer

make ac or dc connections to terminals D and C. This provides more positive clapper action.

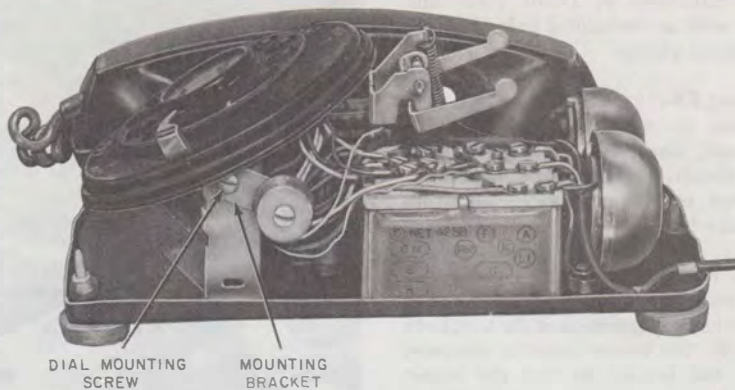

Fig. 8—KS-20419L1 Buzzer Mounted in 500-Type Telephone Set

2.18 When using KS-8108, KS-8109, and KS-8110 type buzzers for dc operation the case becomes part of the circuit and should be insulated from any metal mounting surfaces.

2.19 The KS-20419L1 buzzer operates on 6-10 volt ac only.

3. INSTALLATION

A. Planning

3.01 Consider the following when locating buzzers and bells.

- (a) Use appropriate bracket when placing buzzers in telephone set.
- (b) Locate where signal will be clearly heard.
- (c) The 7-type bells may be mounted on horizontal or vertical surfaces. On vertical surfaces mount bell with gong at top or bottom.
- (d) Locate buzzers and secondary connecting blocks high in desk knee well to avoid disfiguring desks.
- (e) The 7F buzzer (Fig. 1) may be mounted in any position. A preferable position for

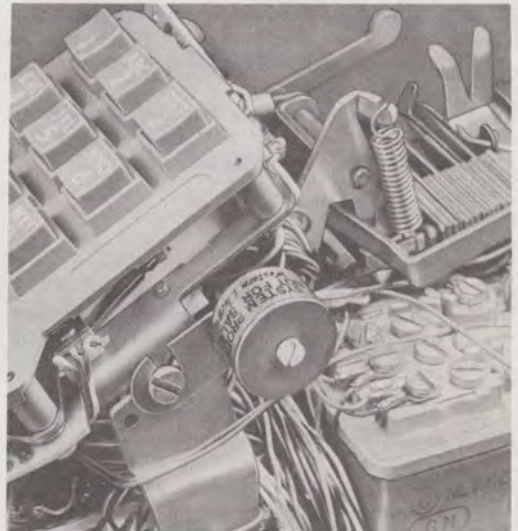

Fig. 9—KS-20419L1 Buzzer Mounted on TOUCH-TONE® Dial Mounting Screw

mounting on vertical surfaces is with armature hanging vertically from hinged end to reduce amount of dust settling on contacts.

(f) Locate a minimum of 1-foot from any equipment with an unshielded induction coil, to reduce magnetic pickup.

(g) Do not mount KS-8108, KS-8109, and KS-8110 type buzzers on metal surfaces unless a backboard is used, since metal base forms part of operating circuit. Countersink backboard mounting screws to prevent screwheads from contacting buzzer base.

(h) Place the KS-20419L1 buzzer inside the telephone set where it will not interfere with electrical or mechanical operation of the telephone set (Fig. 8 and 9). The buzzer circuit is insulated from the case and bracket so that the buzzer can be attached to metal parts of the set.

(i) A 176A-49 backboard is suitable for use on metal desks or other surfaces requiring a backboard.

(j) Use a buzzer where fixed volume buzzer tone is required. Use a bell where a distinctive or louder signal is desired.

(k) The KS-type buzzers are more suitable in CALL DIRECTOR® sets, as they have less induction than the 7-type buzzers.

B. Mounting

3.02 When mounting buzzers directly to a surface use No. 8 pan-head type AB screws of suitable length.

3.03 Refer to Division 461 for information on mounting buzzers in floorduct.

3.04 See Table C for brackets associated with mounting buzzers in telephone sets and to 168-type backboards.

3.05 When mounting KS-8108, KS-8109, and KS-8110 type buzzers on a 70B bracket (Fig. 12) position the buzzer so that it will not interfere with the electrical or mechanical operation of the telephone set, and so the buzzer adjustment screw is accessible.

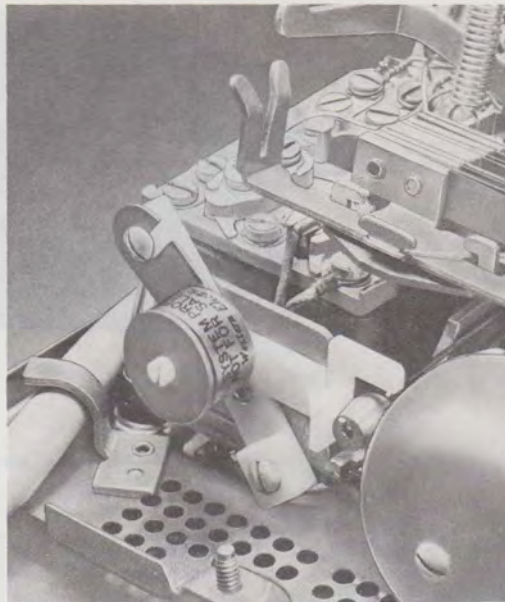

Fig. 10—KS-20419L1 Buzzer Mounted on Bracket of H1A Ringer

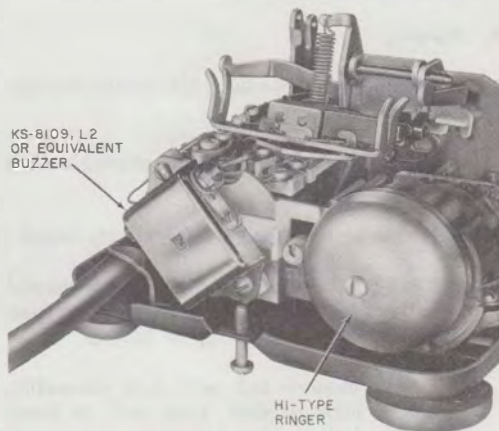

Fig. 11—KS-8109 Type Buzzer Mounted on Bracket of H1A Ringer

♦ TABLE C ♦

MOUNTING BRACKETS OR ADAPTERS

BUZZER	BRACKET CODE	PARTS FURNISHED WITH BRACKET	INTENDED USE	RESTRICTED USE
7F and No. 152A Capacitor	44B	½(2) Screws to mount buzzer and 152A cap. (2) Screws for mounting bracket	All 500 Series Tel. Sets	44A (MD) bracket not for use with 540-, 560-, and 592-type tel. sets
7F	60A (Note 1)	(2) Screws to mount buzzer to bracket	168-type Backboard	
7F or KS-8109L2	65A (Note 3)	(2) Buzzer mounting screws (2) Insulating washers	600 Series <i>CALL DIRECTOR</i> sets	Not for use in 636-, 637-, 638-, and 639-type
KS-8109L2 or KS-20419 L1	70B (Note 2)	(2) Buzzer mounting screws	500 or 2500 Series Tel Sets	Not for use in 500- or 2500-Series sets E/W exclusion switch (Note 4)
7F, KS-8109L2, or KS-20419 L1	71A (Note 3)	(2) Nylon buzzer mounting screws (2) Insulating washers	636-, 637-, 638-, and 639-Type <i>CALL DIRECTOR</i> sets	Mount 7F buzzer (less cover)
9A	219B*	(3) Screws to mount buzzer to adapter plate 11C conn blk	Create 9B buzzer for 322C-03 telephone set	
	220A*	(3) Screws to mount buzzer to adapter plate	Create 9C buzzer for No. 14 local test desk	

Notes:

1. The mounting screws used to secure the 168-type backboard also hold the 60A bracket (Fig. 16).
2. 70B bracket mounts astride ringer coil and is fastened with the same screws that hold core to ringer frame. The spade-tipped leads on F terminal contact with the buzzer case. Boss is also provided on the 70B bracket to ensure adequate clearance.
3. The 65A (Fig. 14) and 71A (Fig. 15) mount on the dial mounting plate with a dial mounting screw.
4. Where both ringer and buzzer signals are needed in these sets replace the C4A ringer with an H1A ringer. Mount KS-type buzzers per (Fig. 10 and 11).

* Adapters



Fig. 12—70B Bracket

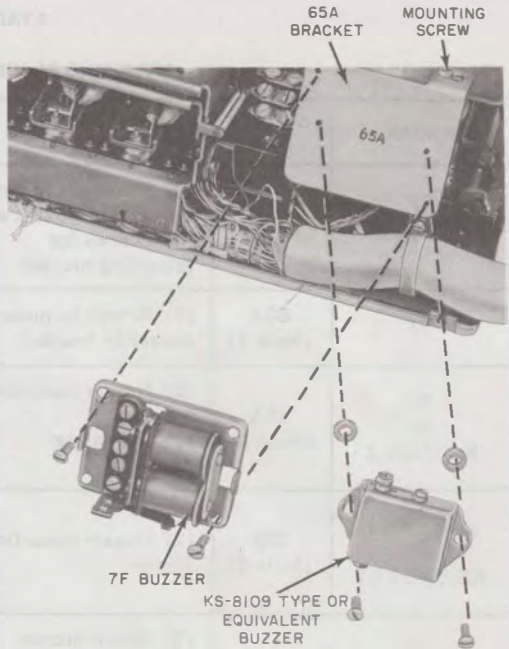

Fig. 14—65A Bracket

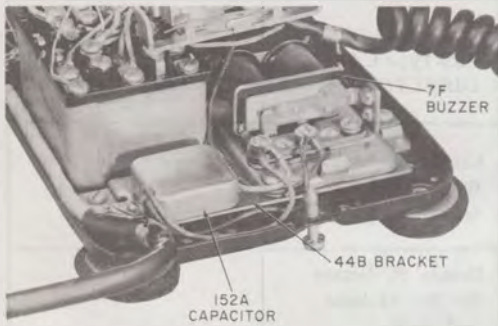

Fig. 13—7F Buzzer and 152A Capacitor Mounted on 44B Bracket

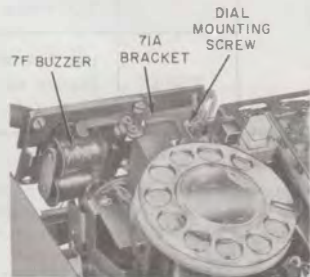

Fig. 15—71A Bracket

4. MAINTENANCE

4.01 Buzzer and bell failure is usually due to one or more of the following:

- Dirty contacts or gummy parts
- Loose connections or poorly soldered terminals
- Insufficient airgap between armature and pole face at hinged end
- Excessive or insufficient armature spring tension
- Armature out of parallel with pole faces.

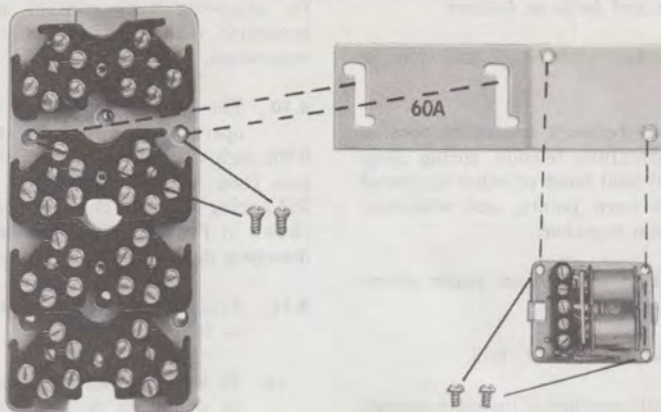

Fig. 16—60A Bracket

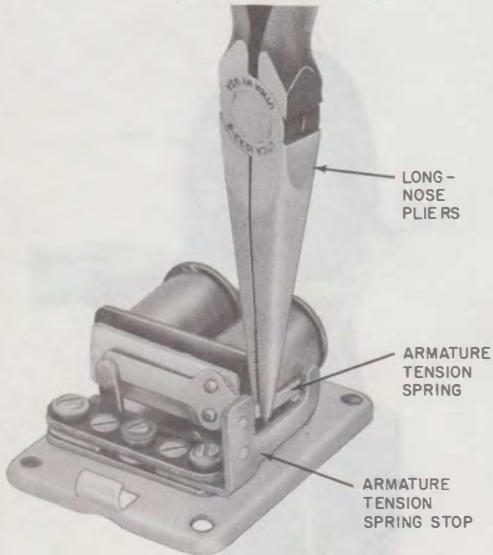

Fig. 17—Adjusting Armature Tension Spring

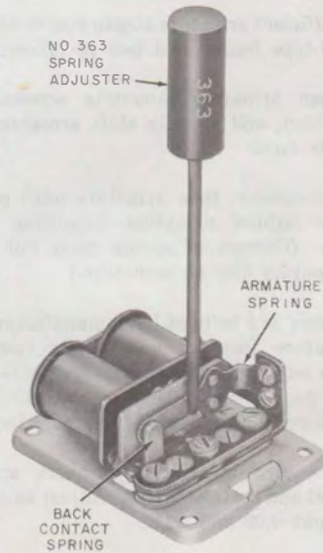

Fig. 18—Adjusting Armature Spring

4.02 Clean buzzers and bells as follows.

- (1) Brush out interior with No. 7 sash tool or equivalent.
- (2) To clean point between armature tension spring and armature tension spring stop, insert strip of Bell Seal bond or other approved cleaning paper between points, and withdraw while pressing them together.
- (3) Repeat operation until clean paper shows no sign of dirt.
- (4) Burnish contacts with 265C tool.

4.03 Buzzers and bells are shop adjusted to operate within the voltage ranges as shown in Table A. Check circuit voltage and if necessary correct.**4.04** Inspect signal for loose connections or poorly soldered terminals.**4.05** There must be a perceptible airgap between armature and pole face at hinge end on 7-type buzzers and bells when the armature stop disc is against other pole face.**4.06** Insufficient armature airgap may be corrected on 7-type buzzer and bell as follows.

- (1) Loosen armature mounting screws, when provided, and slightly shift armature away from pole faces.
- (2) If necessary, turn armature until parallel, then tighten armature mounting screws securely. (Contact of spring must fall wholly within contact disc on armature.)

4.07 Buzzers and bells of later manufacture have armature fastened with rivets instead of screws. To adjust this type, grip armature spring at a point near rivets with long-nose pliers, and bend armature slightly away from pole face.**4.08** After adjusting armature, check armature travel and spring tension. Adjust as outlined in paragraphs 4.09 and 4.11.**4.09** Excessive armature travel may be checked by placing tip of long-nose pliers slightly against armature, moving armature nearer poles face. If this improves tone, reduce armature travel

by adjusting back contact spring toward the armature with long-nose pliers. Check contact separation.

4.10 The contact separation of buzzer and bell operated on direct current is approximately 0.005 inch when armature is held manually against pole face. Adjust as required by applying a No. 363 spring adjuster close to base of the spring as shown in Fig. 18. Give adjuster a slight twist in direction desired. Take care not to kink spring.**4.11** Armature spring tension may be adjusted as follows.

- (a) To increase tension, place long-nose pliers on armature tension spring as shown in Fig. 17 and adjust spring in direction away from coils. This will raise sound pitch of buzzer.
- (b) To decrease tension, adjust spring in direction toward coils. This will lower sound pitch of buzzer.
- (c) Retain airgap between armature and pole face near hinge.

**Fig. 19—Adjusting Clapper Movement**

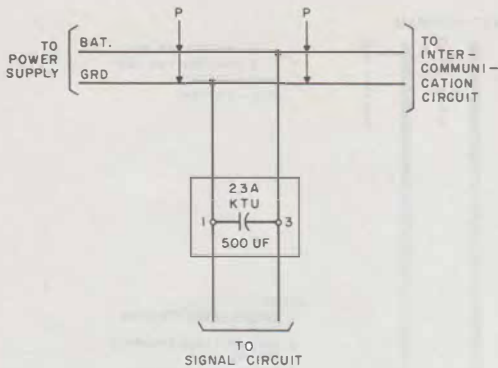

Fig. 20—Noise Suppression Filter

(d) After adjusting, see that armature tension spring rests against armature tension spring stop when armature is in unoperated position (Fig. 17).

Caution: Do not adjust armature spring stop, as this may adversely affect the buzzer or bell operation.

- 4.12 When in place, the cover must not make contact with armature or its mounting bracket. If cover is not held snugly in place, adjust cover springs with long-nose pliers.
- 4.13 If 7-type bell armature vibrates satisfactorily, but the clapper does not strike gong or clapper arm strikes cover, adjust with long-nose pliers (Fig. 19).
- 4.14 Armature travel and contact separation of the KS-8108, KS-8109, and KS-8110 type buzzers are controlled by the adjustable contact screw which is provided.
- 4.15 The bias spring tension is a two position control on the 9-type buzzer. The bias spring is factory set in the high tension notch. Bias adjustment is made through opening in 64A gong.
- 4.16 Except for voltage adjustment the KS-20419L1 buzzer is maintenance free.

5. LIMITATIONS

- 5.01 The number of audible signals operated in multiple by a common pushbutton or 6021-type key is subject to limitations.
- 5.02 Relay equipment may be used to operate a number of audible signals in multiple. Do not exceed maximum load of relay contacts.
- 5.03 Buzzers or bells should be of the same type throughout a pushbutton and buzzer system.

2012A(MD), 2012C, or KS-16184 Transformer

- 5.04 Either a 2012A, 2012C, or KS-16184 transformer may be used for small pushbutton and buzzer systems requiring not more than 1/4 amp.
- 5.05 Where a common battery feeder is used for intercommunicating and signaling, connect a 23A KTU across the signal circuit (Fig. 20).

6. CONNECTIONS

- 6.01 A simplified method of connecting buzzers, bells, and pushbutton keys is to be used on all systems. This method ensures the pairing of all key and buzzer leads throughout the system (Fig. 21 and 22).
- 6.02 Subsequent changes and additions may be made with a minimum of wiring changes.
- 6.03 Pairing of all leads will reduce the possibility of interference in adjacent talking circuits.
- 6.04 Where 7-type bells are connected to 60-cycle alternating current, bell operation may be more satisfactory if the dc terminals are used.
- 6.05 Connect 7-type buzzers or bells as shown in Fig. 23.
- 6.06 Where radio frequency induction is caused by a sparking buzzer or bell contact, operating power should be ac and connections should be to the ac terminals. A 152A capacitor should be used across buzzer contacts when power supply is dc (Fig. 23).

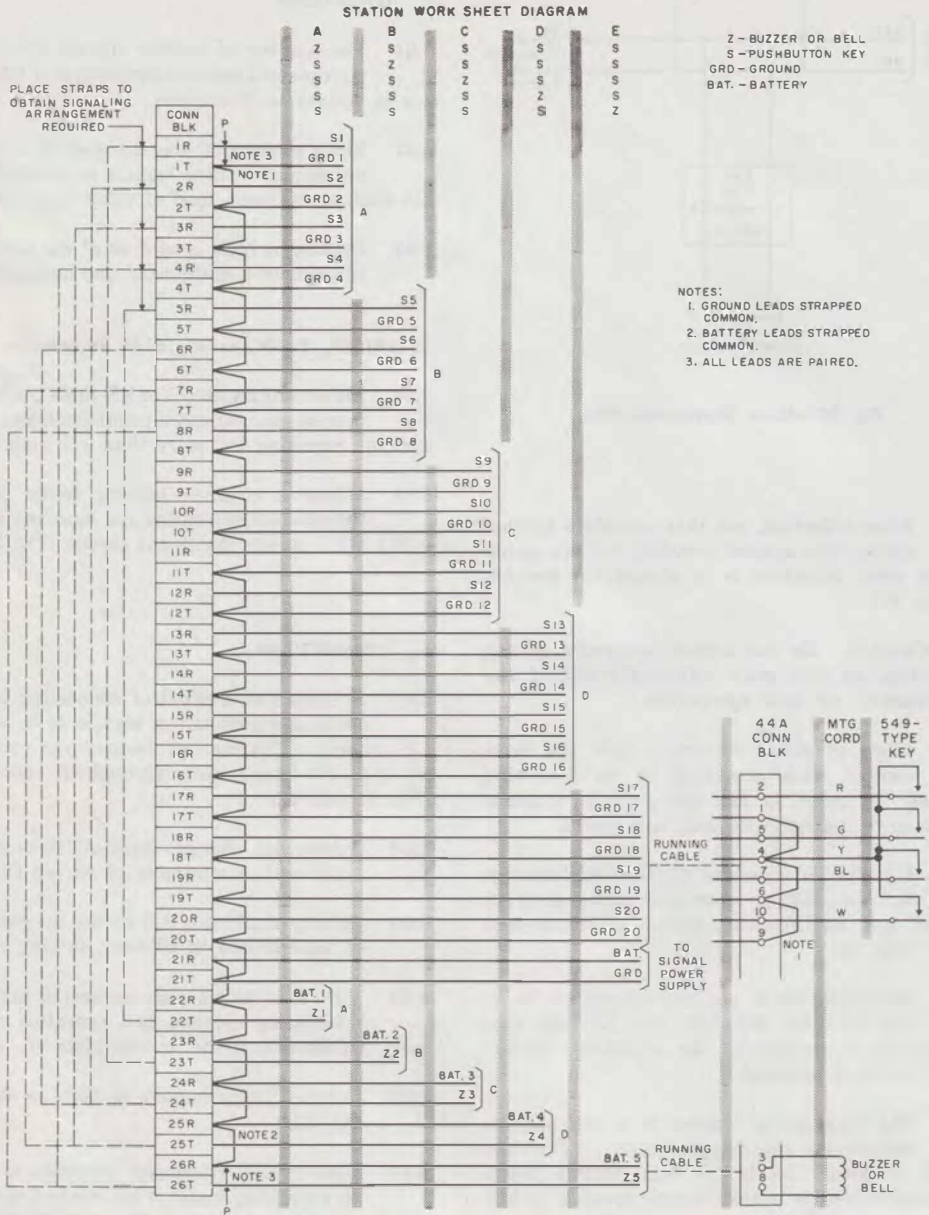

Fig. 21—Large Pushbutton and Buzzer System

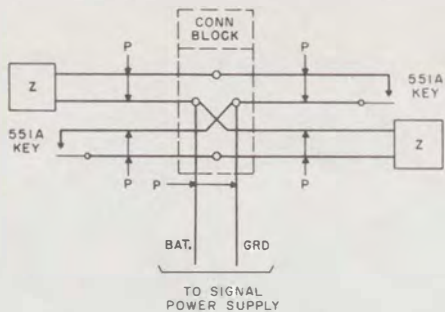

Fig. 22—Small Pushbutton and Buzzer System

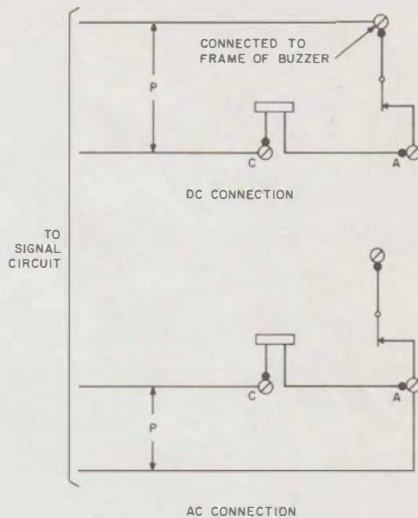

Fig. 24—KS-8108, KS-8109, and KS-8110 Type Buzzer Connections

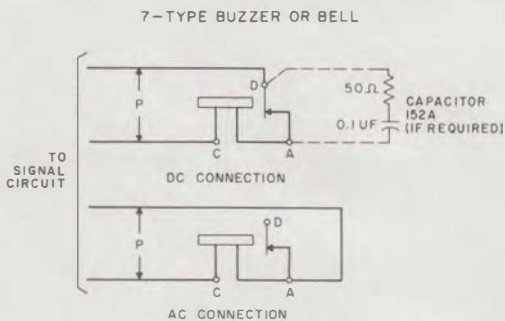

Fig. 23—AC and DC Connections