

4A COMMUNICATION SYSTEM

(COM KEY* 416)

IDENTIFICATION, INSTALLATION, CONNECTION, OPERATION, AND MAINTENANCE CUSTOMER EQUIPMENT

CONTENTS	PAGE	CONTENTS	PAGE
1. GENERAL	3	POWER REQUIREMENTS	21
2. IDENTIFICATION	7	Supplementary Power	22
BASIC FEATURES	7	CABLING RESTRICTIONS	23
OPTIONAL FEATURES	10	SYSTEM CABLING AND CONNECTIONS	24
TELEPHONE SETS	11	TELEPHONE SETS	24
PBX INTERFACE	12	A. Primary Sets	24
FCC REGISTRATION	12	B. Basic Satellite and HFAI Desk Sets	24
ORDERING GUIDE	12	C. BIS Desk Sets	24
A. Telephone Sets	12	D. Basic Satellite Wall Sets	25
B. Optional Apparatus	15	E. BIS Wall Sets	28
C. Optional Components	16	F. HFAI Wall Sets	30
D. Interconnection Components	17	G. All HFAI Sets	30
E. Replaceable Components	17	BASIC FEATURES	31
3. INSTALLATION AND CONNECTION	20	A. CO/PBX and Intercom Line Assignments (Priority Sets Only)	31
PLANNING	20	B. CO/PBX Ringing and DSS Code Assignments (All Sets)	31
ELECTRICAL PROTECTION	21	SUPPLEMENTARY POWER	32
ELECTRO-MAGNETIC INTERFERENCE	21	OPTIONAL FEATURES	33
		A. Music-On-Hold	33

*Trademark of AT&T.

NOTICE

Not for use or disclosure outside the
Bell System except under written agreement

CONTENTS	PAGE	CONTENTS	PAGE
B. Tone-On-Hold	34	ANSWERING CALLS USING BUILT-IN SPEAKERPHONE	60
C. Paging (Telephone Company Provided System)	36	PLACING CALLS USING BUILT-IN SPEAKERPHONE	61
D. Paging (Interface With Customer-Provided System)	39	Built-In Speakerphone Operating Features	61
E. Power Failure Ringing	40	ANSWERING INTERCOM CALLS AT HFAI STATION	61
F. Supplementary Alerting Device Access	43	HFAI Operating Features	62
G. Preset Intercom Voice Signaling	45	CALLING AN HFAI STATION	62
H. Privacy	47	4A SPEAKERPHONE OPERATION	62
I. Station Dial Restriction	49	MISCELLANEOUS OPERATING TECHNIQUES	63
J. Personal Line	49	5. MAINTENANCE	64
K. Code Busy DSS Key	54	DIAGNOSTIC PROCEDURES	64
L. 4A Speakerphone	54	DISASSEMBLY AND ASSEMBLY OF TELEPHONE SETS	65
M. Repertory Dialing	57	A. Faceplate	65
N. External Ringing	57	B. Upper Housing	65
O. Special Handsets	58	C. Lower Housing (All Satellite Desk Sets)	71
FINAL SYSTEM CONNECTIONS	58	D. Wall Housing (All Satellite Wall Sets)	71
4. METHOD OF OPERATION	59	E. Lower Housing (Primary Sets)	71
ANSWERING CALLS USING HANDSET	59		
PLACING CALLS USING HANDSET	60		
HOLD OPERATION	60		

CONTENTS	PAGE
REMOVAL AND INSTALLATION OF COMPONENTS	73
A. DSS Key	74
B. Dial	75
C. Loudspeaker Assembly	78
D. Handset Jack	79
E. Recall Key	79
F. Loudspeaker Volume Control	80
G. Line Key	80
H. BIS Module	81
I. HFAI Module	81
J. Amplifier	82
K. Voice-Signaling Interface Circuit	82
L. Interconnect Field Assembly	83
M. Base and Logic Assembly	84
N. Power Transformer	84

1. GENERAL

1.01 This section provides complete information on the 4A Communication System (COM KEY 416) using 981/2981- and 983/2983-type telephone sets.

1.02 This section is reissued to:

- Add information relative to the Federal Communications Commission (FCC) Registration Program

- Show the 91B connecting block replacing the 91A (MD)
- Show the 33C voice coupler replacing the 33A (MD)
- Show the 30AM apparatus unit replacing the 30A (MD)
- Show the 19B4 power unit replacing the 19B2 (MD)
- Show the 2012D transformer replacing the 2012B (MD)
- Show the D-180980 music-on-hold kit of parts replacing the D-180730 (MD)
- Delete coverage of F-60591 Kit of Parts
- Add information on electrical protection and electro-magnetic interference protection
- Refer to additional external ringers
- Cover use of special handsets
- Add new Table A, combining previous Tables A and B
- Add new Table B
- Revise Table F
- Add new Fig. 7, 10, 26, 33, 39, 40, and 46
- Revise Fig. 8, 9, 11, 12, 21, 24, 28, 32, 38, 43, 44, 48, 49, 50, 51, and 52.

Since this reissue is a general revision, no revision arrows have been used to denote significant changes.

1.03 The 4A System is a packaged, modular key telephone system having a maximum capacity of 16 stations with four common CO/PBX lines, one personal CO/PBX line per telephone, and two intercom paths. A wide selection of basic and optional features is available (see Part 2). The

system includes five types of telephones: (1) primary sets, (2) basic satellite desk sets, (3) basic satellite wall sets, (4) satellite sets with built-in speakerphone (BIS), and (5) satellite sets with hands-free answer on intercom (HFAI). Each primary set contains the control circuitry for two CO/PBX lines and one intercom path and the power circuitry to serve itself and some combination of up to seven satellite sets. The addition of a second primary set doubles the capacity of the system; up to seven more satellite sets can be connected, with each station in the system now served by up to four CO/PBX lines and two intercom paths. The satellite sets provide the same basic services as the primary sets, but they do not contain control and power circuits.

Caution 1: *The 4A System is designed to operate on CO/PBX loops of 20 milliamperes or greater.*

Caution 2: *The 4A System is not intended for installations where off-premises extensions are required.*

1.04 Because the control and power circuitry of the 4A System is contained in the primary station sets, there is no need for separately mounted key service units such as most key systems require. The only equipment required in addition to the telephone sets are interconnecting cables, blocks, adapters, and small externally mounted units for some optional features. Systems with many optional features may require an externally mounted power unit.

1.05 Each 4A station can be programmed by the customer to ring on any combination of the common CO/PBX lines. All stations have access to all common lines in the system; therefore, any set can be assigned as the attendant station, if one is required. Each station also has direct access to the ten intercom codes.

1.06 All 4A telephone sets are available with either rotary or TOUCH-TONE® dialing. The primary set is available only in a desk-type model, but the basic satellite sets can be ordered in both desk and wall configurations. The BIS and HFAI sets are convertible from desk to wall mounting by means of a kit of parts. There are a total of ten telephone set codes in the 980-series (Table A). Figures 1 through 5 illustrate typical sets.

1.07 The 4A System derives its ac power from a standard 117-volt 60-Hz source. The system components are protected by a self-resetting thermal cutout in the power supply of the primary station, making separate fusing unnecessary. The 19B4 power unit, used when supplementary dc power is required, has both input and output fusing.

1.08 While the 980-series telephones provide more optional features than the 830 series (MD) used with the earlier 4A System (Section 518-450-105), the two series are compatible and interchangeable. They can coexist in the same system and 980-series sets can be used to replace 830-series sets in existing installations. However, if supplementary power is required, the primary sets must be from the 980 series.

Note: In a mixed system, optional code busy direct station selection (DSS) keys can only give busy indications for 980-series telephones.

1.09 Certain components and apparatus used with the 4A System have been rated MD and replaced by new units. These units are listed in Table B. Throughout the rest of this practice, all references will be to the current versions of the units, *unless* the procedures applying to the MD unit are different in any way; in the latter case, both units will be given separate coverage.

1.10 Schematics of the telephone sets and apparatus units of the 4A System are contained in SD-69856-01. The schematic of the 1A transmitter-receiver (built-in speakerphone module) is in SD-69800-01.

1.11 For additional information on the following subjects, refer to the documents listed:

4A Speakerphone—Section 512-700-100

33C Voice Coupler—Section 463-341-102

Adjunct Repertory Dials—Section 501-164-201

KS-16301L17 Relay—Section 463-110-100

KS-16626L12 Relay Set—Section 463-120-100

19B4 Power Unit—Section 167-440-201

Wall-Mounting Fasteners—Section 080-720-105

TABLE A

SUMMARY OF 4A COMMUNICATION SYSTEM TELEPHONE SETS AND OPTIONS

TELEPHONE SETS			DESK	BASIC	BASIC	BIS	HFAI	
			PRIMARY	DESK	WALL	SATELLITE	SATELLITE	
OPTIONS			ROTARY	981A01	981A02	981A03	983A01	983A02
			TOUCH-TONE	2981A01	2981A02	2981A03	1983A01	2983A02
OPTION	COMPONENT(S) REQUIRED							
Set Options	Personal Line	30AM Apparatus Unit (Note 1) D-180758 Kit of Parts	•	•	•	•	•	•
	Privacy	D-180729 Kit of Parts	•	•	•	•	•	•
	Wall Mounting	D-180747 Kit of Parts				•	•	
	Code Busy DSS Key	664C Key	•	•	•	•	•	•
	Station Restriction	(Wiring Change Only)	•	•	•	•	•	•
	Impaired Hearing Handset	G6BM Handset D-180851 Kit of Parts	•	•		(Note 2)	(Note 2)	•
	Handset With More Receive Gain Than G6BM	D-180413 Handset D-180851 Kit of Parts	•	•		(Note 2)	(Note 2)	•
	Weak Speech Handset	G7BM Handset D-180851 Kit of Parts	•	•		(Note 2)	(Note 2)	•
	Noisy Location Handset	G8BM Handset D-180851 Kit of Parts	•	•		(Note 2)	(Note 2)	•
	Acoustic or Inductive Coupling Handset	G15A Handset D-180851 Kit of Parts	•	•		(Note 2)	(Note 2)	•
	G-Type Handset Equipped With Shoulder Rest	G4BM Handset D-180851 Kit of Parts	•	•		(Note 2)	(Note 2)	•
	Long Loop, 3-dB Transmit Gain	G36AM Handset D-180851 Kit of Parts	•	•		(Note 2)	(Note 2)	•
	External Speakerphone	4A Speakerphone D-180732 Kit of Parts						•
	Repertory Dialing	Adjunct Repertory Dial 870A1 or 2870A1 D10Y50 Cord		•		(Note 2)	(Note 2)	•
	Built-In Speakerphone	(Factory-Installed)					•	
Hands-Free Answering on Intercom	(Factory-Installed)						•	
System Options	Power Failure Ringing	24B Apparatus Unit						
	Supplementary Alerting Device Access	25A Apparatus Unit KS-16626L12 Relay or KS-16301L17 Relay Alerting Device and its Power Unit						
	Preset Intercom Voice Signaling	26A Apparatus Unit						
	Telephone Company - Provided Paging System	109A Loudspeaker Set						
	Customer-Provided Paging System Interface	27A Apparatus Unit (Note 3)						
	Background Music With Any Paging System	33C Voice Coupler (Note 4)						
	Music-On-Hold	33C Voice Coupler (Note 4) D-180980 Kit of Parts	•					
	Tone-On-Hold	D-180731 Kit of Parts	•					
	External Ringing	E1CM, S1AMP, or L1AM Ringer						
Supplementary Power	19B4 Power Unit							

Note 1: Mounted external to telephone set.

Note 2: Option not offered when set is wall mounted.

Note 3: KS-16626L12 relay may also be required.

Note 4: Only one 33C voice coupler is required per system.

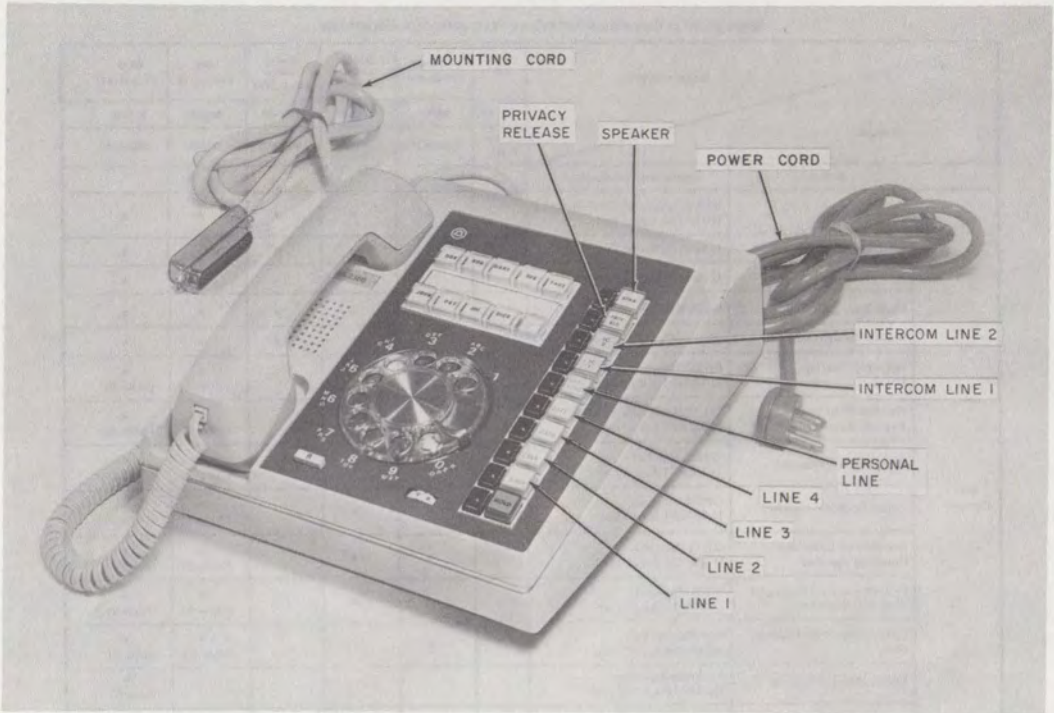

Fig. 1—Primary Telephone Set



Fig. 2—Basic Satellite Wall Telephone Set



Fig. 3—Built-In Speakerphone Satellite Telephone Set

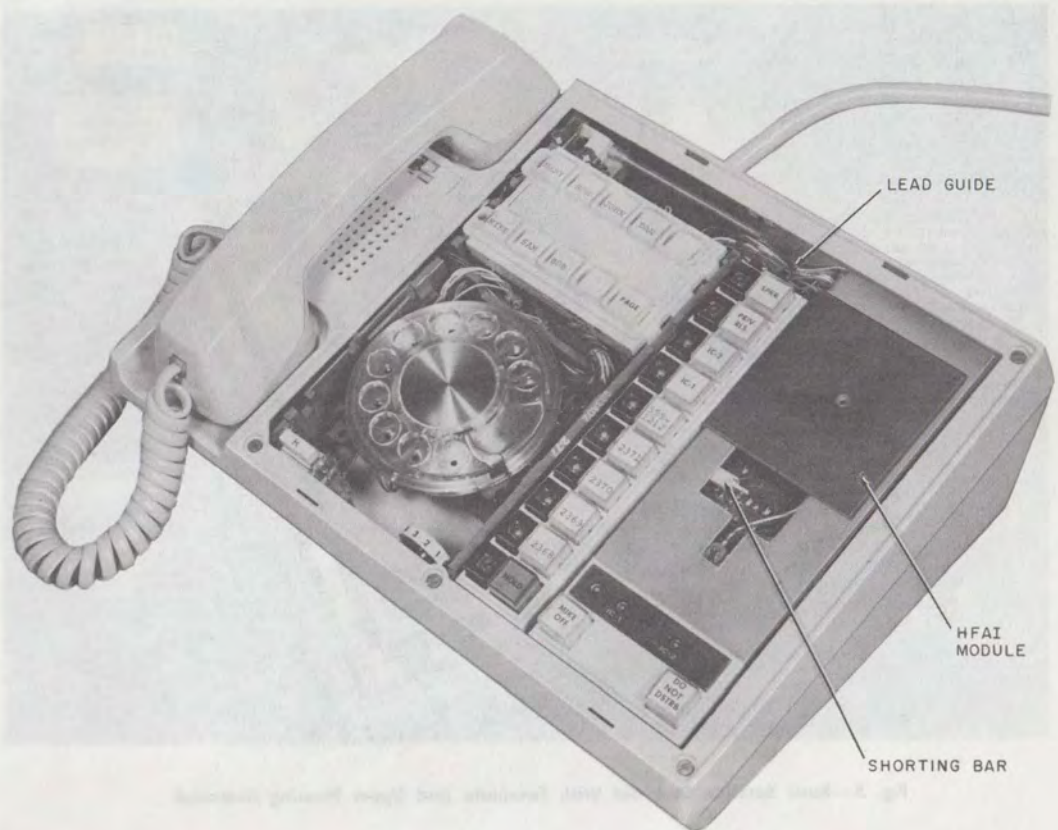

Fig. 4—Hands-Free Answer on Intercom Satellite Telephone Set With Faceplate Removed

E1-Type Ringers—Section 501-251-100

LIAM Ringer—Section 501-258-101

SIAMP Tone Ringer—Section 501-260-100

Electro-Magnetic Interface Protection—X-4235

2. IDENTIFICATION

2.01 The 4A System consists primarily of key telephone sets and various connecting hardware and cables. Basic operating features are supplied as part of the telephone sets, while additional

apparatus, installed in the sets or externally, provides optional features.

BASIC FEATURES

2.02 The following features are provided in all 4A System telephone sets and require no additional installation:

- (a) **Pickup, Hold, and Illumination**—Standard key system pickup, hold, and line status lamp indications, including flash on incoming CO/PBX line calls, steady on answered calls, and wink-on-hold are provided. Systems with one primary set are limited to two common

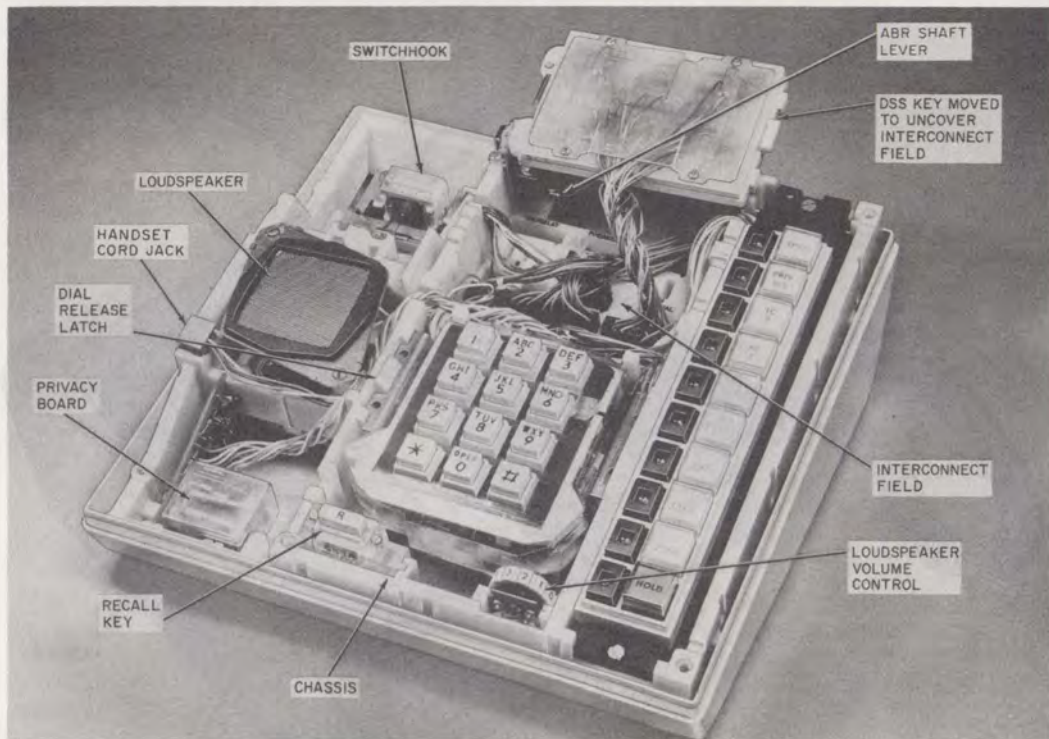

Fig. 5—Basic Satellite Desk Set With Faceplate and Upper Housing Removed

CO/PBX lines; systems with two primary sets can have up to four lines.

- (b) **2-Path Intercom With DSS**—Two paths are provided for intercom calls, each associated with an IC button in the pickup key. A busy path is indicated by a steady lamp adjacent to the IC button. The DSS buttons allow one-way voice signaling of called stations without dialing. A two-way conversation is established when the called party goes off-hook and picks up the intercom path. Ten DSS codes are available; in systems with more than ten stations, codes must be shared. The intercom code is set at each station by means of a programming switch and may be reprogrammed by the customer. Systems with one primary set are limited to a single intercom path; systems with two primary sets have two paths.

- (c) **Automatic Button Restoration (ABR)**—Depressed line or intercom buttons are mechanically returned to the unoperated position when the handset is placed on-hook. This prevents inadvertent intrusion into calls in progress when handset is picked up and prevents lines from being left bridged after a conference call.

- (d) **Built-In Loudspeaker**—The built-in loudspeaker is bridged across the handset receiver when the locking SPKR button is operated, permitting other people in the area to hear both sides of a conversation. The loudspeaker has a thumbwheel volume control on the front of the telephone. This loudspeaker also receives tone and voice signaling.

Note: In BIS and HFAI sets with 4A speakerphone added, the bridging feature is

TABLE B

STATUS OF MANUFACTURE DISCONTINUED (MD) COMPONENTS AND APPARATUS

MD UNIT	REPLACED BY	REASON FOR CHANGE	APPLICATION OF MD UNIT
91A Connecting Block	91B	Meet FCC Registration Requirements in 4A System	Previously used unit can be reused in any installation
24A Apparatus Unit	24B	Meet FCC Registration Requirements in 4A System	Previously used unit can be reused in any installation
30A Apparatus Unit	30AM	Meet FCC Registration Requirements in 4A System	Previously used unit can be reused in any installation
33A Voice Coupler	33C	Meet FCC Registration Requirements in 4A System	Previously used unit can be reused in any installation
D-180730 Music-On-Hold Kit of Parts	D-180980	Meet FCC Registration Requirements in 4A System	Previously used unit can be reused in any installation
19B2 Power Unit	19B4	Meet New Underwriters Laboratories Standards	Any installation
2012B Transformer	2012D	Design Improvement	Any installation

disabled but equivalent service is provided by the speakerphone.

(e) **Tone Signaling**—The alerting signal for incoming CO/PBX lines is a tone source rather than conventional ringing. It is supplied through the built-in loudspeaker. Each station can be individually programmed by the customer to be tone signaled on any combination of incoming CO/PBX lines.

(f) **Voice Signaling**—Voice signaling rather than ringing or tone is provided on the intercom paths. The calling party alerts the called station by voice while holding down the appropriate DSS button. The called station receives this voice signal through its built-in loudspeaker. Multiple stations may be signaled by depressing more than one DSS button at a

time. When the called station picks up the handset, the loudspeaker is attenuated.

(g) **Multiline Conferencing**—Two or more CO/PBX lines can be conferenced by a station by simultaneously depressing the associated locking buttons. Transmission quality is degraded as more lines are added.

Note: Intercom lines cannot be conferenced with CO/PBX lines.

(h) **Recall**—The R button, located below and to the left of the dial on each set, has two functions: (1) to drop a line and reoriginate dial tone without going back on-hook and (2) to signal [flash] the attendant when the 4A System is behind a PBX or Centrex. The R button should be used for these operations instead of depressing

the switchhook which will cause the line or intercom buttons to restore.

(i) **Outgoing Service During Power Failure**—Outgoing CO/PBX calls can be made from the 4A System even when local power has failed.

OPTIONAL FEATURES (TABLE A)

2.03 The following options are available as separately installed items or as features of specific telephones:

(a) **Personal Line**—Each station in the 4A System can be provided with one noncommon, personal CO/PBX line. Each such line requires the installation of a separately mounted 30AM apparatus unit which provides standard key system pickup, hold, and line status lamp indications for that line. The personal line is assigned to a button in the line pickup key. A given personal line may be shared by more than one station in the system, and it will ring at every station where it is connected. Music- or tone-on-hold is available as an option with this feature.

(b) **TOUCH-TONE Dialing**—Rotary dialing can be replaced by TOUCH-TONE dialing by ordering appropriate telephone codes. Rotary dial and TOUCH-TONE dial sets may be intermixed in the 4A System without additional equipment.

(c) **Privacy/Privacy Release**—A station equipped with the optional privacy feature is prevented from entering a CO/PBX call in progress. Privacy is implemented on a per-station basis by installation of a D-180729 Kit of Parts. The station can be released from this condition by the operation of the privacy release feature at the *other* station(s) on the call. All 980-series telephone sets have the factory-wired PRIV RLS button, which should be designated only when at least one station in the system has privacy installed.

Note: The privacy feature applies to all CO/PBX lines but not to intercom lines.

(d) **Station Restriction**—Placing of all outgoing CO/PBX calls from a station can be prevented by shorting bar changes inside the set.

(e) **Music-On-Hold**—Music from customer-provided music source is supplied to CO/PBX lines placed on hold. Installation of one 33C voice coupler per system and a D-180980 Kit of Parts in each primary station and each 30AM apparatus unit is required.

(f) **Tone-On-Hold**—An alternative to music-on-hold, it provides intermittent bursts of tone to CO/PBX lines placed on hold. Installation of a D-180731 Kit of Parts in each primary station and each 30AM apparatus unit is required.

(g) **Supplementary Alerting Device Access**—The operation of an external relay to control bells, gongs, horns, etc, by incoming ringing on CO/PBX lines and/or by depression of an assigned DSS button is provided. This feature requires installation of a 25A apparatus unit, an external relay, and a signal with its power source.

(h) **Paging**—Voice announcements can be made over 109A loudspeaker sets or a customer-owned and maintained paging system. The latter arrangement requires the use of a 27A apparatus unit to provide proper interface with the 4A System. Background music may be provided by means of customer-provided music and a 33C voice coupler (same source and coupler used for music-on-hold). The paging path is activated by operation of a DSS button assigned to this feature. The 109A loudspeaker contains two customer-accessible volume controls for adjusting background music and paging volume; background music is automatically muted during paging.

Note: For normal voice inputs, the minimum output of the 27A apparatus unit is -30 dBm into 600 ohms.

(i) **Preset Intercom Multiple Voice Signaling**—Allows any number of preselected stations and/or paging loudspeakers to be voice signaled simultaneously by means of a designated DSS button. A 26A apparatus unit is required for this feature.



Remember that a DSS code used for supplementary signaling, paging, or preset intercom signaling is no longer available as a station code.

(j) **Code Busy DSS Key**—Lamps in this DSS key indicate that one or more stations assigned to a DSS code are off-hook or being voice signaled. This feature can be implemented on a per-station basis by replacing the factory-installed DSS key with an identical size 664C key which contains LEDs.

Note: In systems where 980-series sets are mixed with 830-series sets, the 664C key will indicate busy 980-series sets only.

(k) **Power Failure Ringing**—The 24B apparatus unit provides two C4B ringers and associated circuitry to connect the ringers to the CO/PBX lines in the event ac power to the 4A System fails. Installation of a 24B for each primary station is required.

(l) **Hands-Free Answer on Intercom**—The HFAI is available only as a built-in feature of two 4A telephones (983A02 and 2983A02). It allows incoming intercom calls to be answered without any manual action by the called party; the microphone in the HFAI is turned on by the incoming call. The HFAI station user can operate a "mike-off" button to disable the microphone while still receiving voice signaling or use a "do-not-disturb" button to both disable the microphone and block voice signaling.

(m) **Speakerphone**—Speakerphone service permits hands-free conversations on CO/PBX and intercom lines and is available in the 4A System in two configurations only.

- (1) Built-in speakerphone telephone sets (983A01 and 2983A01).
- (2) An external 4A speakerphone connected to the HFAI telephone set. The installation of a D-180732 relay Kit of Parts is required. The 4A speakerphone cannot be used with any other 4A System telephone sets.



In all telephones with speakerphone, the ability to bridge the set loudspeaker across the incoming line with the SPKR button is disabled.

(n) **Repertory Dialing**—This feature is provided by connection of an 870A1 (rotary dial) or 2870A1 (TOUCH-TONE dial) adjunct repertory dial with a D10Y-50 cord to desk models

of satellite telephone sets. It allows numbers stored in the dial memory to be called by the operation of a single button.

(o) **Supplementary Power**—A 19B4 power unit can be used to increase the basic power capacity of the 4A System and to compensate for the additional power required for HFAI sets, code busy DSS keys, and 109A paging loudspeakers. If any of these optional features are employed in the 4A System, supplementary power may be required.

Note: The 19B4 power unit supplies only 24-volt battery to the 4A System. The built-in power supplies in the primary sets continue to provide lamp power to the system and control circuit power to the primary sets when a 19B4 is connected.

(p) **External Ringing**—This feature is provided by connecting an external ringer (such as an E1CM, SIAMP, or LIAM) across the CO/PBX tip and ring leads at the network interface.

(q) **Special Purpose Handsets**—The K1C handset supplied with each 4A System desk telephone can be removed and replaced with a standard G4 or G15 handset or with one designed for long loop, handicapped users, or noisy locations. A D-180851 Kit of Parts must be installed on the new handset to adapt it to the 4A System telephone.

TELEPHONE SETS

2.04 The 980-series telephone sets are completely new in design; all components are connected by means of plugs and jacks for quick assembly and replacement. Primary and basic satellite sets are packaged in housings of the same width, but the primary sets are somewhat deeper because of the control and power circuitry they contain. The BIS and HFAI satellite sets require a wider housing to accommodate their additional features.

2.05 The basic features described in paragraph 2.02 appear in all sets. The 663A2 line key contains ten buttons—hold, four common CO/PBX lines, an optional personal line, two intercom paths, an optional privacy release, and built-in loudspeaker on/off control. The LED status lamps are associated with each line and intercom path button. The 664B DSS key consists of two horizontal rows of five

buttons, each of which may be assigned to one or more stations, a paging loudspeaker, supplementary ringing or preset multiple signaling. Between the two rows of DSS buttons and under a hinged cover are the programming switches for DSS code assignment and CO/PBX line ringing control. The built-in loudspeaker is located under the handset, and its volume control is below and to the right of the dial. The recall (R) key is below and to the left of the dial. All sets employ the K1C modular handset. The rotary dial is standard, but TOUCH-TONE dial is available.

2.06 The internal arrangement of the telephones is based on the use of a molded plastic chassis to which the components of the set are attached and an electrical interconnect field into which the components are plugged (Fig. 5). The interconnect field also contains positions for plugging in optional features and switches A through H for adapting the set to options. Outside connections are made by way of the set mounting cord or separate cords for such optional features as personal lines, 4A speakerphone, and repertory dialing. In primary sets (Fig. 6), the mounting cord plugs into a wiring harness which distributes leads to the line key and the control logic board. In the other desk-type sets, the mounting cord plugs directly into the line key. The system connector cable is intended to be plugged directly into the wall sets without the use of mounting cords, which are not supplied with wall sets.

2.07 Mounted on the base of each primary set is a logic board containing control and power circuitry for two CO/PBX lines and one intercom path, and a transformer for supplying ac power to the logic board (Fig. 6). Up to seven satellite telephones can derive their power from one primary set. Each primary set contains a polarity guard circuit which prevents battery reversals on the CO/PBX lines from interfering with TOUCH-TONE dial operation and multiline conferencing.

PBX INTERFACE

2.08 The 4A System will interface with all PBXs except that it cannot provide for ground-start operation of CO trunks which bypass the PBX in the event of PBX power failure. In all other respects, the system performs on PBX lines in the same manner as on CO lines. For PBX use, the only restriction on the number of telephone sets is that each 25-pair connector cable system

can serve a maximum of 2 primary stations and 14 satellite stations. Although 4A telephone sets behind a PBX have full capabilities, they can contact telephones in other systems only via PBX lines. To signal the PBX operator, the recall button must be used.

FCC REGISTRATION

2.09 The 4A System was tested per, and complies with, the rules and regulations in Subpart D of Part 68 of the FCC rules. The FCC has defined a register-only date after which new product, which is registered, can be installed. Old product which is not registered but had previously been installed is "grandfathered" and may be reinstalled.

2.10 The system may be interconnected in a "home-run" configuration, in a bridged configuration, or in a combination of both methods (Fig. 7). All interconnections between the 4A System and the telephone network must be made via a standard jack (eg, RJ11C or RJ14C) and fully protected premises wiring. The type of network address signaling is E and the ringer equivalence number for the system varies from one to five as a function of the number of power failure ringer apparatus units a particular configuration contains.

ORDERING GUIDE

A. Telephone Sets

2.11 Order the required telephone sets from the following list. Sets are supplied in ivory only and are shipped with E-6723 key designation tabs and disposable faceplates. Order the desired permanent faceplates separately:

- (a) **Primary Sets**—Order one for a system with one or two CO/PBX lines and one intercom path; order two for a system with three or four CO/PBX lines and two intercom paths.
 - 981A01 (desk model, rotary dial; includes D50AB-50 mounting cord)
 - 2981A01 (desk model, TOUCH-TONE set; includes D50AB-50 mounting cord).
- (b) **Satellite Sets**—Order as required.

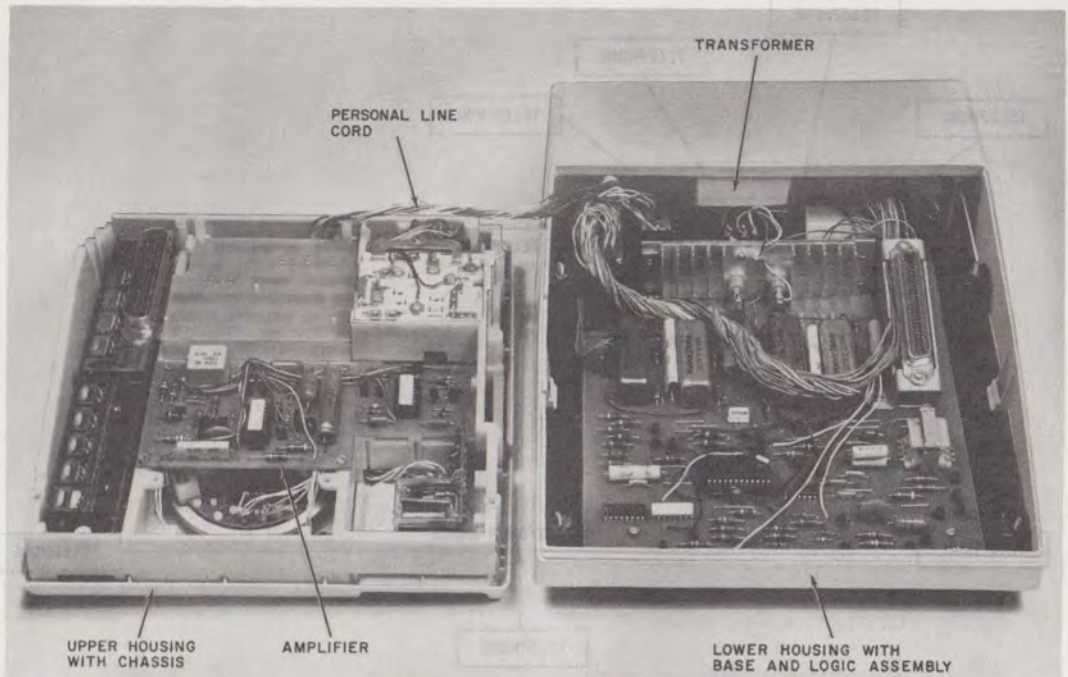

Fig. 6—Primary Set Disassembled

(1) Basic Satellite **Desk** Sets:

- 981A02 (desk model, rotary dial; includes D50AW-50 mounting cord)
- 2981A02 (desk model, TOUCH-TONE set; includes D50AW-50 mounting cord).

(2) Basic Satellite **Wall** Sets:

- 981A03 (wall model, rotary dial; mounting cord not included)
- 2981A03 (wall model, TOUCH-TONE set; mounting cord not included).

(3) The **BIS** Satellite Sets:

- 983A01 (desk model, rotary dial; includes D50AW-50 mounting cord, D8W-50 speakerphone power cord, 2012D transformer, and 86A connecting block to provide an interface for

D or H station wire or D inside wiring cable used to connect the 2012D to the BIS set)

- 2983A01 (desk model, TOUCH-TONE set; includes D50AW-50 mounting cord, D8W-50 speakerphone power cord, 2012D transformer, and 86A connecting block to provide an interface for D or H station voice or D inside wiring cable used to connect the 2012D to the BIS set).

Note: Desk model of BIS set can be converted to wall set by use of kit of parts listed in paragraph 2.14.

(4) The **HFAI** Satellite Sets:



Keep in mind when ordering HFAI sets that each one consumes as much power as any other two stations; therefore, either the total number of stations in the system may have

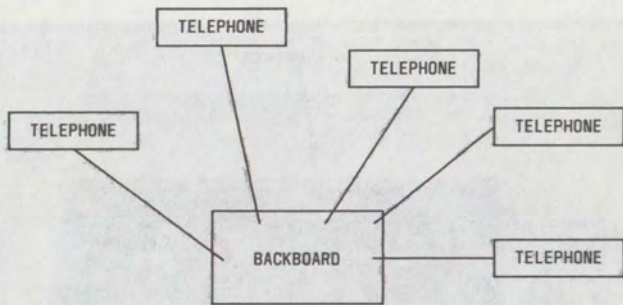

A. BASIC HOME-RUN WIRING SYSTEM

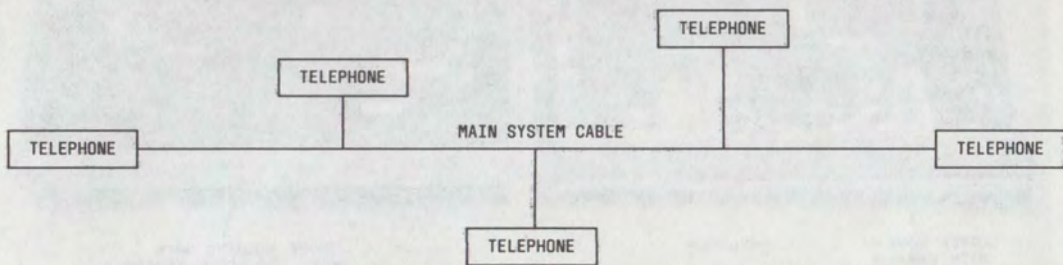

B. BASIC BRIDGED WIRING SYSTEM

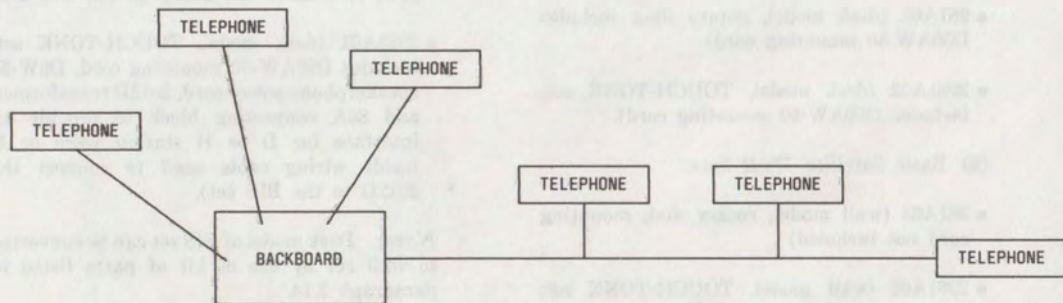

C. COMBINATION OF BRIDGED WITH HOME-RUN SYSTEM

Fig. 7—Simplified Block Diagram of Basic Wiring Methods

to be reduced or supplementary power used (see paragraph 3.13).

- 983A02 (desk model, rotary dial; includes D50AW-50 mounting cord)
- 2983A02 (desk model, TOUCH-TONE set; includes D50AW-50 mounting cord).

Note: Desk model of HFAI set can be converted to wall set by use of kit of parts listed in paragraph 2.14.

2.12 Order the following as required depending on the types of telephones being installed:

- Block, Connecting, 91B (order one for each primary station)
- Faceplate, 61C-† (for 981-type sets)
- Faceplate, 261C-† (for 2981-type sets)
- Faceplate, 63D-† (for 983-type sets)
- Faceplate, 263D-† (for 2983-type sets)

†Add color code suffix as follows:

Avocado (-100)
Teak (-108)
Walnut (-109)
Gold (-111)
Orange (-112)
Brown (-113)
Red (-114)
Blue (-115)
Black (-118)

B. Optional Apparatus

2.13 Order the following apparatus as required to implement options (see Table A).

(a) **Personal Line:**

- Unit, Apparatus, 30AM (order one for each personal line to be installed; includes 95B1 power unit)
- D-180758 Kit of Parts (consists of 86A connecting block, D8W-50 cord, jack assembly, plug retainer, and mounting bracket; order one for each primary, basic satellite, or

HFAI satellite set to be equipped with a personal line; do not order for BIS satellite set to be equipped with a personal line).

(b) **External 4A Speakerphone** (order one of each of the following for each HFAI station to be equipped):

- Adapter, 223C (includes D16H-50 cord and M2FG cord)
- D-180732 Kit of Parts (includes relay board and button stop for SPKR button)
- Loudspeaker, 108A (any color)
- Transmitter, 680A (any color)
- D-180508 Kit of Parts (provides ivory housing for loudspeaker and ivory trim for transmitter)
- Unit, Power, 85B1-49.

(c) **Repertory Dialing:**

- Dial, Repertory, Adjunct, 870A1 (rotary dial) or 2870A1 (TOUCH-TONE dialing) (order one for each desk-type satellite station to be equipped for repertory dialing)
- Cord, D10Y-50 (order one for connecting dial to telephone; 2 feet long)
- Unit, Power, 95B1 (order one for each repertory dial).

(d) **Power Failure Ringing:**

- Unit, Apparatus, 24B (order one for each primary set to be provided with power failure ringing).

(e) **Access to Supplementary Alerting Device:**

- Set, Relay, KS-16626L12 or Relay, KS-16301L17 (order one for use with 25A apparatus unit to operate an auxiliary signal)
- Unit, Apparatus, 25A (order one for each supplementary signaling device to be operated)
- Desired alerting unit and its power source.

(f) Preset Intercom Voice Signaling:

- Unit, Apparatus, 26A (order one for each preset intercom voice-signaling arrangement to be installed).

(g) Paging:

- Set, Loudspeaker, 109A (order quantity required for paging and background music; includes wall mounting bracket with 85A connecting block attached, D8W cord, and four rubber washers).



Each 109A loudspeaker consumes as much power as a primary, basic satellite, or BIS set. Refer to paragraph 3.14.

- Coupler, Voice, 33C (one is required for background music on any paging system; *can be same one used for music-on-hold*)
- Unit, Apparatus, 27A (order one for interface between 4A System and a customer-owned and maintained [COAM] paging system)

Note: The 27A will not drive COAM speakers directly.

- Set, Relay, KS-16626L12 (order one for use with COAM paging system that requires a contact closure).

(h) External Ringing:

- Ringer, E1CM, S1AMP, or L1AM (order up to three for each CO/PBX line to be equipped with external ringing but no more than two if power failure ringing is provided).

(i) Supplementary Power:

- Unit, Power, 19B4 (order one if the power requirements of the system being installed exceed the capacity of the built-in power supplies in the primary sets; refer to paragraph 3.14 for details of calculating power requirements)

- Cord, Power (order one of required length for 19B4 power unit):

824013262 (P-40J326)—1-1/2 feet

824013270 (P-40J327)—2 feet

824013288 (P-40J328)—4 feet

824013296 (P-40J329)—6 feet

824010995 (P-40J099)—12 feet.

C. Optional Components

2.14 Order the following components as required to implement options (see Table A).

(a) Privacy:

- D-180729 Kit of Parts (privacy circuit board; order one for each station to be locked out).

(b) Music-On-Hold:

- Coupler, Voice, 33C (order only one per system when music-on-hold is provided and/or when background music is provided on paging system)
- D-180980 Kit of Parts (music-on-hold circuit board; order one for each primary station and each personal line to be equipped with music-on-hold).

(c) Tone-On-Hold:

- D-180731 Kit of Parts (tone-on-hold circuit board; order one for each primary station and each personal line to be equipped).

(d) Wall Mounting:

- D-180747 Kit of Parts (order one for each BIS or HFAI set to be converted from desk set to wall set).

(e) Code Busy Indication:

- Key, 664C (code busy DSS key; order one for each station to be equipped for busy status indication; includes E-6873 key designation tabs).



Each 664C key consumes as much power as a primary, basic satellite, or BIS set.

(f) **Handsets for Special Applications:**

- Handset, G6BM (impaired hearing, modular)
- Handset, D-180413 (more receive gain than G6BM, modular)
- Handset, G7BM (weak speech, modular)
- Handset, G8BM (noisy location, modular)
- Handset, G15AM (general use, modular)
- Handset, G4BM (G-type equipped with shoulder rest, modular)
- Handset, G36AM (long loop, 3-dB transmit gain, modular)
- D-180851 Kit of Parts (ivory transmitter and receiver covers; order one for each handset).

(d) Cables, Connector (for system cabling between telephone sets; specify desired length):

- A25B (single-ended)
- A25B (double-ended)
- A25D (single-ended)
- B25A (double-ended).

(e) Cable, D Inside Wiring

(f) Cord, D50AB-50 (7 feet or 18 feet; extension mounting cord for satellite sets; **not intended for extending primary set mounting cord**)

(g) Cord, D4BU or D6AP (double-ended, modular)

(h) Wire, Station, D, H, or SK

E. Replaceable Components**2.16 All Sets:**

- Amplifier, 841009103
- Assembly, Dial, Rotary, 841010770 (includes 8TA-119 dial)
- Assembly, Dial, TOUCH-TONE, 841010762 (includes 35AU3A dial)
- Assembly, Loudspeaker, 841009053
- Cord, H4DU-50 (handset cord)
- Form, E-6723 (key designation tabs for line keys and standard DSS keys)
- Form, E-6873 (key designation tabs for code busy DSS keys)
- Handset, K1C-50
- Jack, 616JK (handset jack)
- Key, 663A2 (line key)
- Key, 664B (DSS key)
- Key, 683C (recall key)

D. Interconnection Components

2.15 Unless otherwise noted, the following list consists of typical components recommended for interconnecting the parts of the 4A System. Refer to Fig. 8 and 9 for typical connection arrangements.

- (a) Adapter, 3-Way Bridging, KS-19252 type
- (b) Block, Connecting, 91B (**required** for connecting primary set to network interface and system cable)
- (c) Blocks, Connecting, 66-Type in various configurations:
- Backboard, 184A1 (includes two 66B4-25 blocks)
 - Backboard, 184B2 (includes four 66B4-25 blocks)
 - Block, Connecting, 66E3-25
 - Adapter, 161A (adapts 66-type terminals for spade-tipped leads).

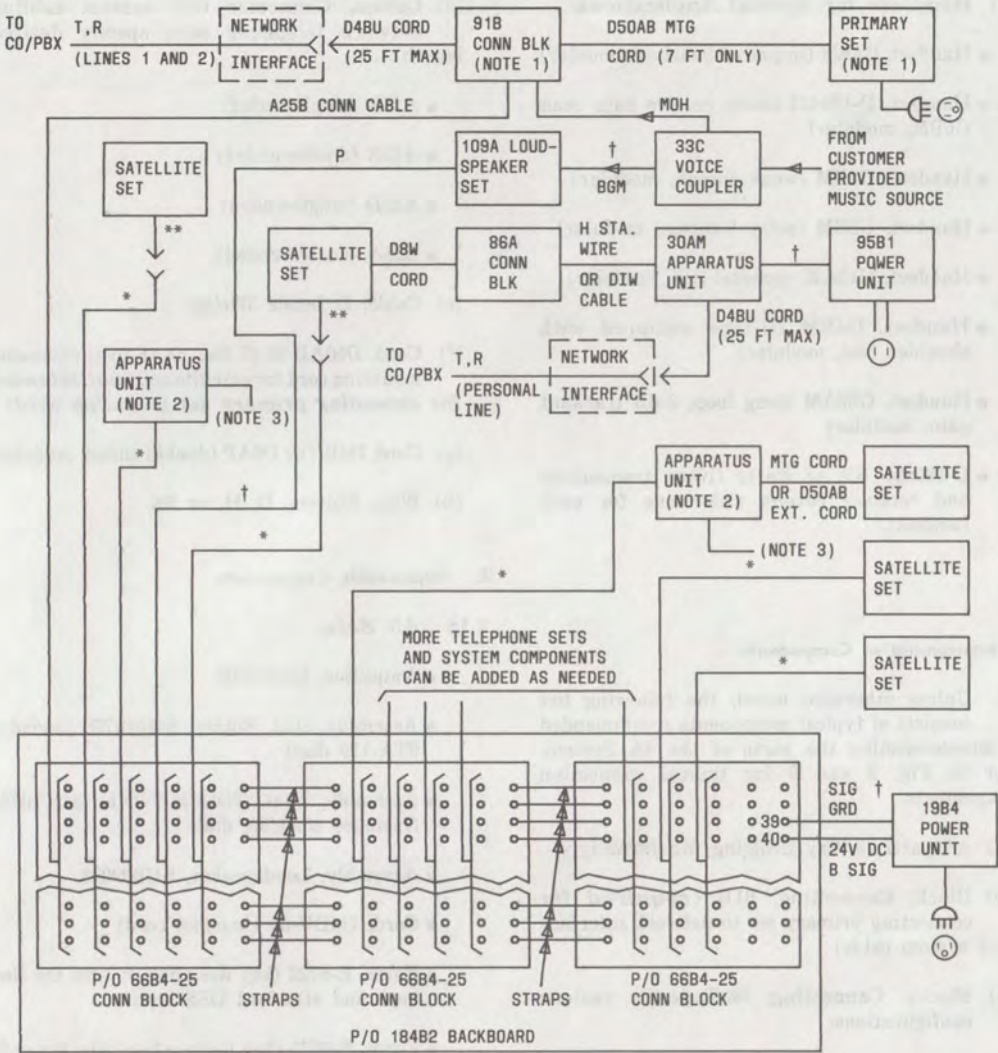

SEE NOTES 1, 2 AND 3 OF FIG. 9.

* SYSTEM CABLING (25 PAIR) MAY CONSIST OF D INSIDE WIRING (IW) CABLE OR B25A, A25B OR A25D CONNECTOR CABLES.

** SATELLITE SETS CONNECTED VIA MOUNTING CORDS SUPPLIED OR D50AB EXTENSION CORDS, USED WITH SYSTEM CONNECTOR CABLE OR 66E3-25 BLOCK WITH DIW CABLE.

† D OR H STATION WIRE OR DIW CABLE.

P - PAGING
 BGM - BACKGROUND MUSIC
 MOH - MUSIC ON HOLD

Fig. 8—Typical Installation Using "Home-Run" Connections

- D-180828 Kit of Parts (963E-2 connectors for use as shorting bars on interconnect field)
- Potentiometer, 842618985 (loudspeaker volume control).

2.17 Primary Sets:

- Assembly, Base, and Logic, 841009087 (includes base, control logic board, and wiring harness)
- Assembly, Field, Interconnect, 841009954
- Cord, D50AB-50 (mounting cord, 7-foot only)
- Housing, Upper, 61AU-50
- Housing, Lower, 61BL-50
- Transformer, KS-21361L5 (includes 6-foot power cord and heat sink).

2.18 Basic Satellite Sets:

- Assembly, Field, Interconnect, 841009954 (wall sets only)
- Assembly, Field, Interconnect, 841009988 (desk sets only)
- Cord, D50AW-50 (mounting cord, desk sets only)
- Housing, Lower, 61AL-50 (desk sets only)
- Housing, Upper, 61AU-50
- Housing, Wall, 61AY-50 (wall sets only).

2.19 BIS Satellite Sets:

- Assembly, Field, Interconnect, 841015449
- Circuit, Interface Signaling, Voice, 841010788
- Cord, D8W-50
- Cord, D50AW-50
- Housing, Lower, 63AL-50
- Housing, Upper, 63AU-50

- Transformer, 2012D
- Transmitter-Receiver, 1A (BIS module)

2.20 HFAI Satellite Sets:

- Assembly, Field, Interconnect, 841015050
- Cord, D50AW-50
- Housing, Lower, 63AL-50
- Housing, Upper, 63AU-50
- Module, HFAI, 841010796.

3. INSTALLATION AND CONNECTION

PLANNING

3.01 Consult with the customer to determine where the 4A System stations should be installed, optional features desired, the best routes for interconnecting cables, intercom code assignments, paging requirements, and the optimum locations for connecting blocks, apparatus units, adapters, etc.

Caution: *Remind the customer that after installation has been finished, primary station power cords must remain plugged in or service will be interrupted.*

3.02 Select the most appropriate method of interconnecting the stations of the 4A System (Fig. 7). Use existing cabling from a previous installation, if possible.

Caution: *If supplementary power from a 19B-type power unit is needed, the "home-run" method of cabling must be used.*

(a) "Home-run" cabling—In this method, each station is separately cabled back to a common cross-connection field such as a 184B2 backboard. A typical "home-run" installation is shown in Fig. 8. The "home-run" cabling method is preferred over other methods because it is usually simpler to install and allows maximum system growth.

(b) Bridged cabling—In this method, each station is bridged across a main cable which carries

system signals. Bridging points are provided by KS-19252 bridging adapters and/or 66E3-25 connecting blocks. See Fig. 9 for a typical bridged installation. The bridged method should only be used when all system power can be supplied from the primary set(s) and where significant system growth is not expected.

(c) Combination—A basic “home-run” system can be modified, if supplementary power is not needed, by bridging several stations across a direct line from the backboard. This method is useful where the distribution of stations is very unsymmetrical or where a close group of stations is remote from the rest of the system.

Caution: *The 91-type connecting block must always be used for connecting a primary set into the 4A System.*

3.03 In all installations, regardless of the cabling method used, a primary station is connected into the system by plugging its 7-foot mounting cord into the associated 91B connecting block (Fig. 10). The 91B block also provides a modular jack for connection to the network tip and ring interface with a D4BU cord.

3.04 In existing installations, 91A (MD) connecting blocks (Fig. 11) may be used to interface between primary sets and CO/PBX lines; it is permissible to reuse these blocks in other installations.

3.05 Apparatus units 24B through 27A can be mounted where there is convenient access to system cabling. Each unit has input and output connectors which mate with the system cable connectors, allowing the unit to be inserted between stations or at the end of a cable run. Specific instructions for the location of apparatus units and other optional external equipment are included in the installation instructions for particular features.

3.06 Select and order the appropriate apparatus according to the job requirements (see ORDERING GUIDE).

ELECTRICAL PROTECTION

3.07 Under normal conditions, the 4A System will provide satisfactory performance in the presence of surges in the telephone plant caused by lightning. If care is exercised to follow good protection practices as discussed in Sections

518-010-105, 876-100-100, and 876-300-100, there should be no need to install a coupled bonding conductor.

3.08 Coupled Bonding Conductor—Under unusual circumstances, a particular installation may experience a high incidence of lightning-related troubles. This might be due to the excessive length of the bonding conductor between the protector and power grounds. Where the length of the bond between these grounds exceeds 20 feet, use of a coupled bonding conductor is recommended.

3.09 A coupled bonding conductor follows the same route as the inside wiring cable. This conductor can consist of a shield, spare pairs of the inside wiring cable, or a wire tie-wrapped to unshielded cable. It is connected to the lug on the building entrance facility protector and to the equipment single point ground terminal. ***Due to the mutual coupling between this wire and the tip and ring conductors, the potential difference appearing between the equipment ground and the protector lug is minimized.***

3.10 In an actual 4A System installation, the coupled bonding conductor should be connected between the green wire ground terminal of the 117-volt 60-Hz power outlet serving each primary set, 19B4 power unit, or 30AM apparatus unit and the protector lug. To facilitate connection to the power outlet green wire ground, an outlet adapter such as the Hubbell part 5291 (brown) or 5291-1 (ivory) can be used.

ELECTRO-MAGNETIC INTERFERENCE

3.11 The 4A System has been designed with adequate electro-magnetic interference (EMI) protection for most installations. However, a few installations very near radio transmitters may require additional EMI protection for either tip and ring or intercom circuits. Instructions for EMI protection are contained in X-4235, conversion of 981/2981- and 983/2983-type telephone sets (4A System).

POWER REQUIREMENTS

3.12 The customer is responsible for providing suitable 117-volt 60-Hz power outlets, not under control of switches, for the following apparatus of a 4A System installation: each primary set, 19B-type power unit, BIS station, 4A speakerphone,

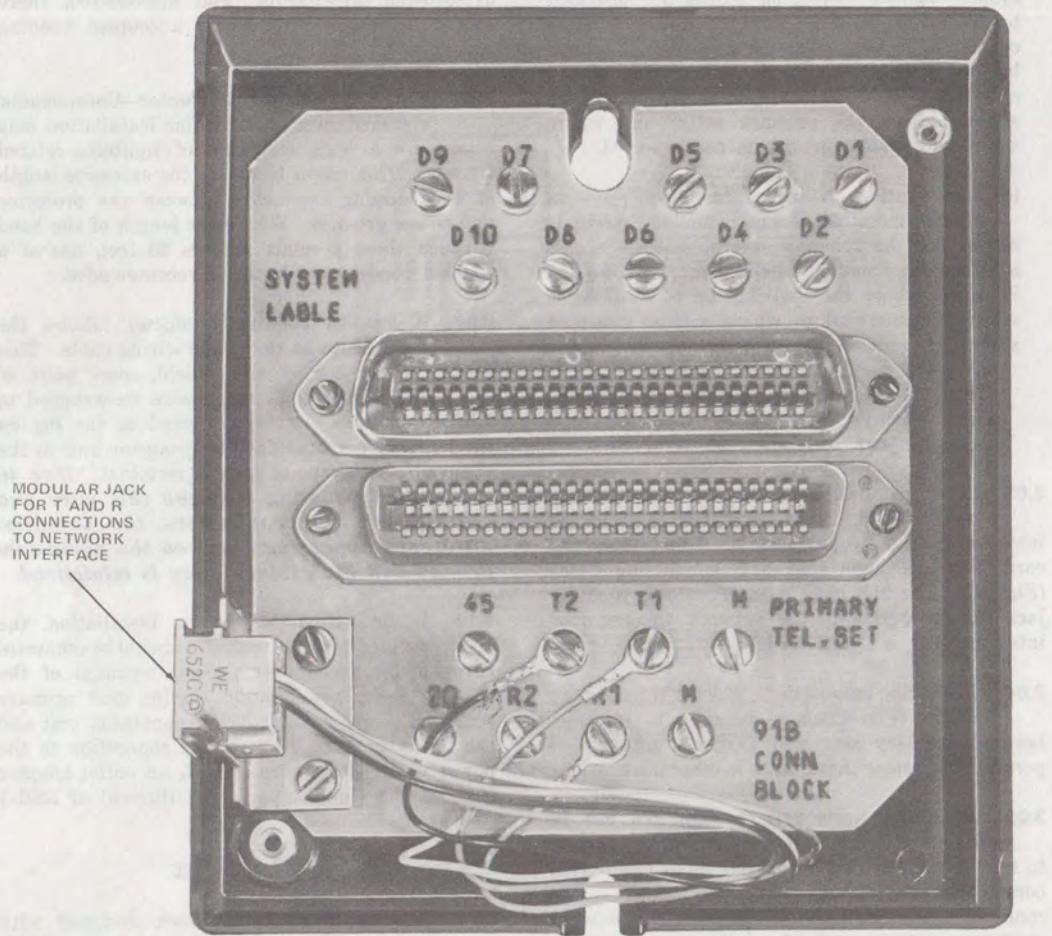

Fig. 10—91B Connecting Block

repertory dial, and 30A-type apparatus unit. The outlets should be separately fused, where possible, to avoid accidental system shutdown.

Caution: Plug primary set and power unit cords into grounded outlets only, in order to meet Underwriter's Laboratory conditions for listing and to provide proper system static electricity discharge protection. Make no connections between any point in the system and building ground, except

for the plug-ended 117-volt power cords and the 33-type voice coupler.

Supplementary Power

3.13 Sufficient power is available from the built-in power supplies in the primary sets for most 4A System installations. However, a concentration of optional features (HFAI sets, 109A loudspeakers, code busy DSS keys) can make it necessary to install a 19B4 power unit for supplementary power.

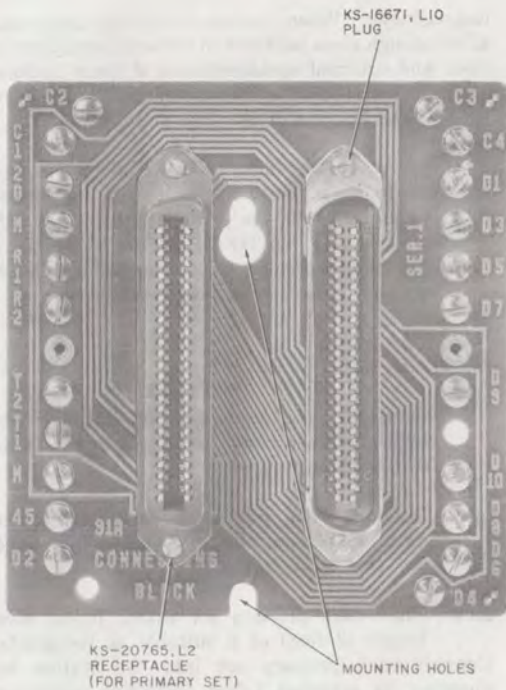

Fig. 11—91A (MD) Connecting Block

3.14 In order to determine whether supplementary power is required, follow this procedure to get the **station equivalent number** of the installation.

- (a) Calculate the values below based on the particular equipment being installed:

(Number of non-HFAI sets, including primary sets) \times 1 =

(Number of HFAI sets) \times 2 =

(Number of 664C code busy DSS keys in excess of two per system) \times 1 =

(Number of 109A loudspeaker) \times 1 =

Sum (station equivalent numbers) =

- (b) If the system has one primary station and the station equivalent number is greater

than 8, install a 19B4 power unit and use the "home-run" method of system connection.

Note: Refer to paragraph 3.35 for detailed installation and connection instructions for the 19B4 power unit.

- (c) If the system has two primary stations and the station equivalent number is greater than 16, install a 19B4 power unit and use the "home-run" method of system connection.

Example: Installation has one primary set, four basic satellite sets with code busy DSS keys, two HFAI sets, one BIS set, and one 109A loudspeaker.

(a) $6 \times 1 = 6$ (non-HFAI sets)

$2 \times 2 = 4$ (HFAI sets)

$2 \times 1 = 2$ (664C keys)

$1 \times 1 = 1$ (loudspeaker)

Sum = 13.

Therefore, a 19B4 power unit is required.



Supplementary power cannot extend the system capability (either 1 or 2 primary sets) beyond 16 station sets or 32 station equivalents.

CABLING RESTRICTIONS

Caution: No more than 2000 running feet (total) of cable should be used for interconnecting the stations in any installation.

3.15 **Station Interconnection**—In installations where bridged cabling is used (Fig. 9), the maximum distance between any satellite station and both primary stations or between primary stations must not exceed the restrictions in Table C. In a small system where only one primary station is required and bridged cabling is used, the total number of station equivalents must not exceed eight since supplementary power cannot be used. When two primary sets are used with bridged cabling, the limit is sixteen.

TABLE C

LIMITATIONS ON CABLE LENGTH AND SYSTEM SIZE IN BRIDGED SYSTEM

NUMBER OF STATION EQUIVALENTS	MAXIMUM CABLE FEET FROM SATELLITES TO BOTH PRIMARY STATIONS*
10 or less	1000
11	900
12	800
13	700
14	600
15	500
16	400

* Sum of cable length from satellite set to first primary set and cable length from satellite set to second primary set. Total number of feet in any installation shall not exceed 2000 feet.

3.16 Personal Line Cabling—Personal lines do not utilize the system interconnection cables but require separate connections between stations and 30AM apparatus units. Figure 12 illustrates the limitations on the connection of personal lines. Bridged cabling can connect a maximum of 16 sets to a 30AM apparatus unit. Refer to paragraph 3.56 for detailed instructions on installing personal lines.

SYSTEM CABLING AND CONNECTIONS

3.17 Install the necessary connecting blocks, bridging adapters, apparatus units, and backboard at the desired locations and connect them with appropriate connector cables. Use the shortest possible lengths of cable consistent with other requirements of the installation. Where single-ended cables are used, cut them down on the connecting blocks in standard color-code sequence (Table D).

TELEPHONE SETS

3.18 Carefully unpack the telephone sets and install them at the locations requested by

the customer. When placing desk-type telephones, allow enough room adjacent to the sets for repertory dials and external speakerphones if these options are to be installed. Put the appropriate designation tabs in the buttons of the line and DSS keys.

Note: Do not install PRIV RLS tabs in any sets unless at least one station in the system is equipped with the privacy feature. On BIS satellite sets and HFAI sets to be equipped with 4A speakerphone, do not install the SPKR tab; this button is inoperative.

A. Primary Sets

Warning: Do not plug in the primary station power cords until all installation is complete.

Caution: Do not use any extension cords between the set mounting cord and the 91B block.

3.19 Place each primary set within power cord length (6 feet) of a suitable ac receptacle. Connect each primary set into the system by plugging its attached 7-foot D50AB-50 mounting cord directly into the assigned 91B block.

B. Basic Satellite and HFAI Desk Sets

3.20 Connect each set into the system with the attached D50AW-50 mounting cord; plug its free end into its assigned bridging adapter or extension cable.

C. BIS Desk Sets

3.21 Connect each set into the system with the attached D50AW-50 mounting cord; plug its free end into its assigned bridging adapter or extension cable. The BIS satellite desk stations require an additional connection to provide power for the built-in speakerphone. Mount the 86A block (Fig. 13) supplied with each BIS set in a convenient place near the station, and plug the D8W-50 cord extending from the back of the set into it. Use inside wire to connect terminals 7 and 8 of the 86A block to the 2012D transformer supplied with the set. **Do not plug the 2012D into an ac receptacle until all installation is complete.**

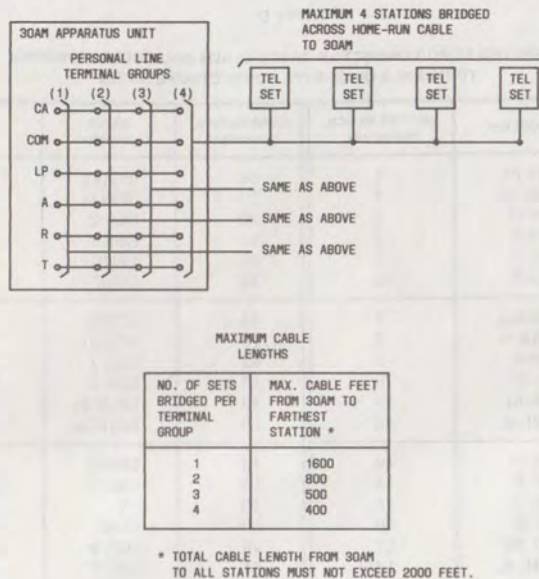

Fig. 12—Personal Line Cabling Limitations

D. Basic Satellite Wall Sets

3.22 The wall model of the basic satellite telephone is a separately coded set and is equipped with a wall mounting plate and appropriate hardware. It is intended to be connected directly to a system connector cable and is, therefore, not supplied with a mounting cord.

3.23 There are three basic methods of connecting a wall set into the system—(a), (b), and (c):

(a) A system cable can be run along the wall surface to the location where the set is to be mounted and connected directly to the set (Fig. 14).

(1) Attach the wall mounting plate to the wall using four No. 8 screws. Place a spacer, supplied with the set, on each screw so that the plate stands off from the wall.

(2) If the cable connector has a screw at the end, remove and discard the screw.

(3) Remove the connector mounting screw (Fig. 15) from the top of the connector bracket on the wall plate and save for Step (6). (The lower bracket screw is captive to the bracket and should be left in place.)

(4) Position the cable connector on the mounting brackets with the flange on its outer end between the stationary upper bracket and the floating clamp, and the flange on its lower end under the lower bracket (Fig. 15).

(5) Start the lower bracket captive screw through the lower flange of the connector so that the connector is held loosely on the wall plate.

(6) Put the mounting screw removed in (3) back into the upper bracket and run it through the flange of the connector and into the floating clamp. Tighten the screw enough to pull the floating clamp up firmly against the underside of the flange, but **do not overtighten**.

TABLE D
MOUNTING CORD/CONNECTOR CABLE LEADS AND CORRESPONDING
TERMINALS ON 66-TYPE CONNECTING BLOCKS

CONNECTOR TERMINAL	DESIG-NATION	COLOR	66-TYPE BLOCK TERMINAL	CONNECTOR TERMINAL	DESIG-NATION	COLOR	66-TYPE BLOCK TERMINAL	
26	T(1)	W-BL	1	38	ICT(1)	BK-G	25	
1	R(1)	BL-W	2	13	ICR(1)	G-BK	26	
27	A(1)	W-O	3	39	DSS 2	BK-BR	27	
2	CA1	O-W	4	14	DSS 1	BR-BK	28	
28	LP(1)	W-G	5	40	LP(IC1)	BK-S	29	
3	LC(1)	G-W	6	15	LC(IC1)	S-BK	30	
29	T(2)	W-BR	7	41	ICT(2)	Y-BL	31	
4	R(2)	BR-W	8	16	ICR(2)	BL-Y	32	
30	A(2)	W-S	9	42	DSS 4	Y-O	33	
5	CA2	S-W	10	17	DSS 3	O-Y	34	
31	LP(2)	R-BL	11	43	LP(IC2)	Y-G	35	
6	LC(2)	BL-R	12	18	LC(IC2)	G-Y	36	
32	T(3)	R-O	13	44	DSS 6	Y-BR	37	
7	R(3)	O-R	14	19	DSS 5	BR-Y	38	
33	A(3)	R-G	15	45	+V	Y-S	39	
8	CA3	G-R	16	20	COM	S-Y	40	
34	LP(3)	R-BR	17	46	DSS 8	V-BL	41	
9	LC(3)	BR-R	18	21	DSS 7	BL-V	42	
35	T(4)	R-S	19	47	DSS 10	V-O	43	
10	R(4)	S-R	20	22	DSS 9	O-V	44	
36	A(4)	BK-BL	21					
11	CA4	BL-BK	22		PRI-MARY			
37	LP(4)	BK-O	23		SATEL-LITE			
12	LC(4)	O-BK	24					
				48	MOH	+V	V-G	45
				23	MOH	COM	G-V	46
				49	T1/T3	+V	V-BR	47
				24	R1/R3	COM	BR-V	48
				50	T2/T4	+V	V-S	49
				25	R2/R4	COM	S-V	50

(7) Tighten the lower bracket screw so that the connector is securely mounted and does not wobble or shift around.

(8) Place the strain relief strap on the cable about 6 inches from the connector. Secure the cable to the lower edge of the mounting plate with the cable positioned as shown in Fig. 14.

(b) In some installations, a connector cable may be concealed in the wall and brought through an opening behind the telephone set (Fig. 16).

(1) Attach the wall mounting plate to the wall using four No. 8 screws. Position the plate over the opening in the wall so the cable can enter through the hole in the plate and

in such a way that the connector hood fits into the opening when mounted to the bracket. If the opening is too small to provide clearance for the hood, place a spacer on each mounting screw so the plate stands off from the wall.

(2) Attach the cable connector to the wall plate as described in paragraph 3.23(a)(2) through (7).

(3) Push any excess cable into the opening.

(c) If the connector cable cannot reach the location where the set is to be mounted or if the cable has been previously cut down on a 66-type connecting block, use a D50AB mounting cord as an extension cord.

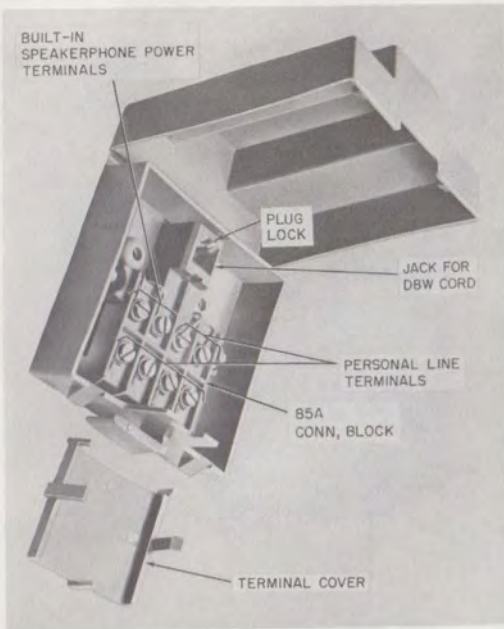

Fig. 13—86A Connecting Block

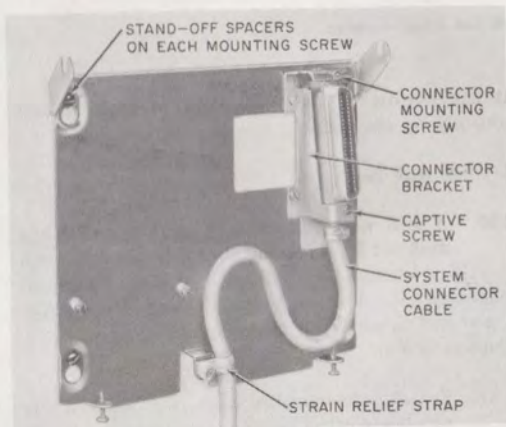

Fig. 14—Wall-Mounting Plate With Connector Cable Attached

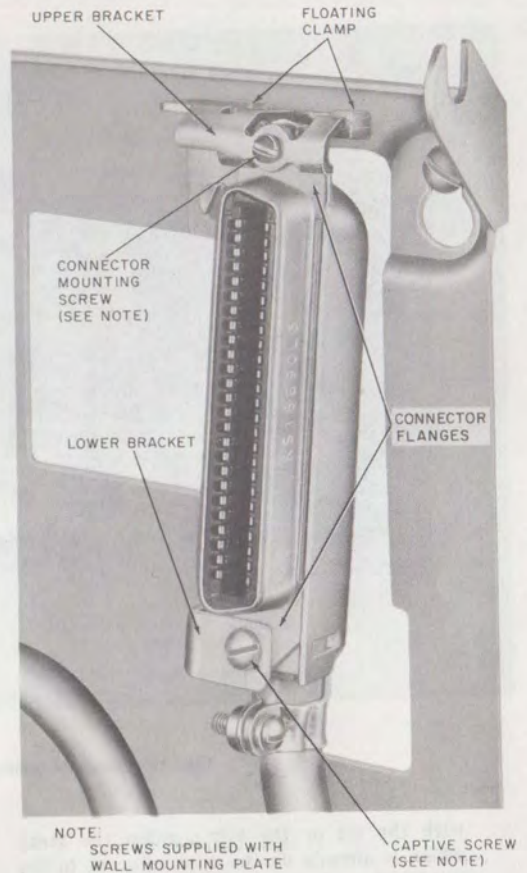

Fig. 15—Detail of Connector Mounting on Wall Plate

- (1) Attach the wall mounting plate to the wall using four No. 8 screws.
- (2) Mount a D50AB cord to the wall plate as described in paragraph 3.23(a)(2) through (7).

Note: If a D50AB cord is not available, use a D50AW mounting cord (Fig. 17). Do not attach the connector of the D50AW to the wall plate like the D50AB, but instead plug it directly into the line key connector in the back of the set. Secure the cord to the wall housing with the strain relief strap supplied

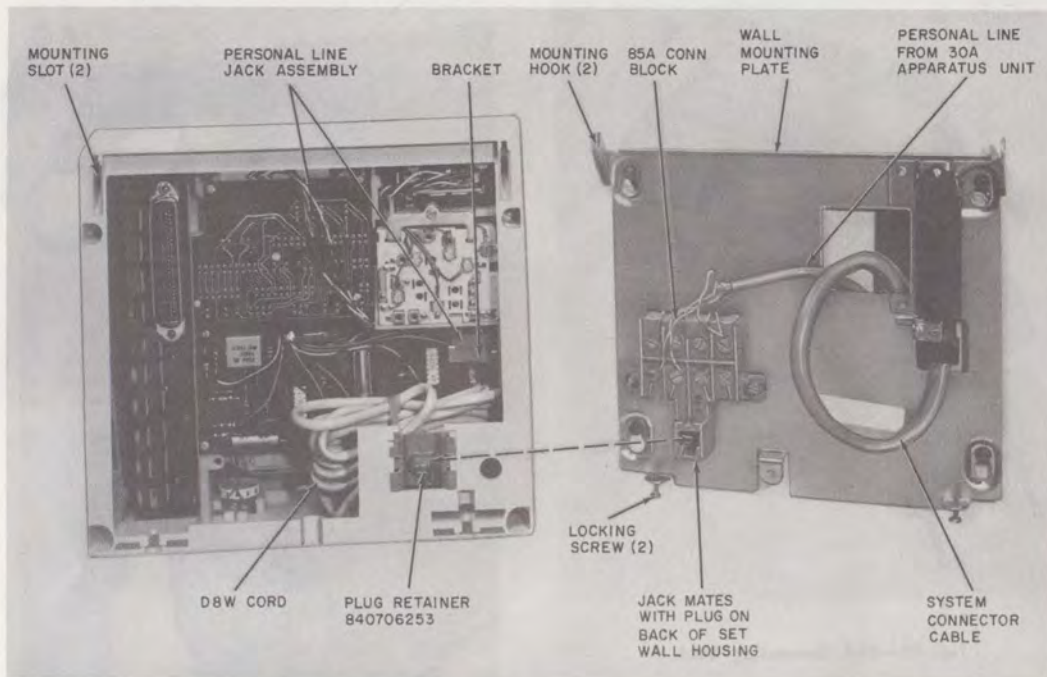

Fig. 16—Basic Satellite Wall Set Disassembled

with the set or the kit; position the strap which is already on the cord adjacent to the inside edge of the housing. **Remove the connector bracket from the wall mounting plate to prevent interference with the cord connector.** Before placing the set on the wall plate, position the cord inside the set as shown, and make sure the connector is tightly engaged. Plug loose end of extension cord into system cable or bridging connector.

3.24 Attach the wall telephone set to its associated wall mounting plate by tilting the set about 30 degrees and engaging the hooks at the top of the plate in the slots in the upper corners of the set housing (Fig. 18). Swing the set down so the line key plug engages the connector mounted on the wall plate. While pressing the set firmly against the plate, tighten the two locking screws

at the bottom of the wall plate to hold the set securely on the plate.

E. BIS Wall Sets

3.25 A BIS wall set must be converted from a desk set by replacing its lower housing with a wall housing supplied with a D-180747 wall mounting kit. This kit also contains a wall plate, a handset hook, and other necessary hardware. Convert the set as follows:

- (a) Remove the number card retainer and the number card (Fig. 19).
- (b) Remove the screw under the number card and lift out the housing blank.
- (c) Replace the housing blank with the handset hook from the kit and secure it with the screw.

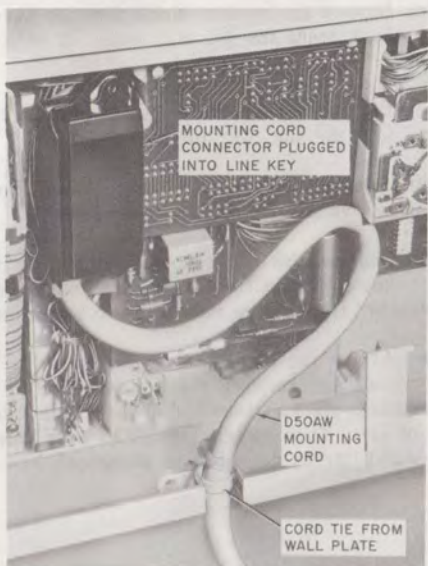

Fig. 17—D50AW Mounting Cord Connected to Wall Set



Fig. 18—Mounting Wall Set on Wall Plate



Fig. 19—Handset Hook

- (d) Put the number card and its retainer back into the slot over the screw.
- (e) Turn the set over and loosen the six captive screws which hold the lower housing.
- (f) Before removing the lower housing from the set, free the D8W cord from its strain relief in the housing.
- (g) Replace the lower housing with the wall housing from the kit. (The mounting cord attached to the lower housing is no longer used.)
- (h) Position the microphone on the BIS module in the lower right corner of the set in relation to the wall housing microphone port by aligning the two white marks on the microphone with the two marks on the housing.
- (i) Insert the free end of the D8W cord into the plug retainer from the kit of parts.
- (j) Snap the plug retainer onto the wall housing (Fig. 14) so the cord plug will mate with the jack in the 85A connecting block to be mounted on the wall plate (see paragraph 3.26).
- (k) Fold up the excess D8W cord, tie it with the plastic cord tie supplied with the kit, and store it inside the set behind the plug retainer.

3.26 Attach the wall plate from the kit to the wall and connect the system cable to the connector bracket as described in paragraph 3.23(a), (b), or (c).

3.27 Convert the 86A connecting block (Fig. 12) supplied with the set to an 85A block and mount it on the wall plate as follows:

- (a) Using a screwdriver, carefully pry the 85A connecting block portion away from the mounting cover. (The cover will not be used.)
- (b) Remove the white plastic plug lock from the top of modular jack of the 85A block.

Warning: *If the plug lock is not removed, the D8W cord plug will lock into the 85A block when the telephone is attached to the wall plate, and it will be extremely difficult to remove the telephone again.*

- (c) Mount the 85A block on the wall mounting plate with the two screws supplied with the plate (Fig. 16).
 - (d) Using inside wire, connect terminals 7 and 8 to the output terminals of the associated 2012D transformer. **Do not plug the 2012D into an ac outlet until all installation is complete.**
- 3.28 Complete the mounting of the BIS wall set by attaching the telephone to the wall plate as described in paragraph 3.24.

F. HFAI Wall Sets

3.29 An HFAI wall set must be converted from a desk set by replacing its lower housing with a wall housing supplied with a D-180747 wall mounting kit. This kit also contains a wall plate, a handset hook, and other necessary hardware. Convert the set as follows:

- (a) Remove the number card retainer and the number card (Fig. 19).
- (b) Remove the screw under the number card and lift out the housing blank.

- (c) Replace the housing blank with the handset hook from the kit and secure it with the screw.

- (d) Put the number card and its retainer back into the slot over the screw.

- (e) Turn the set over and loosen the six captive screws which hold the lower housing.

- (f) Replace the lower housing with the wall housing from the kit. (The mounting cord attached to the lower housing is no longer used.)

3.30 Attach the wall plate from the kit to the wall and connect the system cable to the connector bracket as described in paragraph 3.23(a), (b), or (c). Then attach the HFAI telephone to the wall plate as described in paragraph 3.24.

G. All HFAI Sets

3.31 Each HFAI telephone set contains a factory-installed shorting bar which restricts its hands-free answer capability to intercom path 1. For the set to operate properly in a system with two intercom paths, the shorting bar must be removed.

3.32 If the system being installed has only one primary set and one intercom path, make no modification to the sets; if the system has two primary sets and two intercom paths, modify each HFAI set as follows:

- (a) Remove the faceplate (paragraph 5.07)
- (b) Find the shorting bar mounted on two pins on the inner left side of the HFAI module (Fig. 4)
- (c) Pull the shorting bar off the pins and discard it
- (d) Replace the faceplate.



If an existing system is ever expanded from one to two intercom paths, be sure to remove the shorting bars in all HFAI modules as described in paragraph 3.32.

BASIC FEATURES**A. CO/PBX and Intercom Line Assignments (Primary Sets Only)**

3.33 Primary sets are factory-wired so the two incoming CO/PBX lines are picked up on line buttons 1 and 2 and the intercom on IC1. If the system uses two primary sets, one set must be modified to connect CO/PBX lines 3 and 4 and intercom path 2 to line buttons 3 and 4 and IC2. This is accomplished by changing a connector inside one set as follows:

- (a) Remove the power transformer and heat sink assembly from the back of the set by loosening the two retaining screws under the rear of the set (Fig. 20) and pulling out on the heat sink. It is not necessary to remove the screws but only to back them out about 1/8 inch. Pulling gently on the power cord to dislodge the transformer from the plug inside the set is permissible.
- (b) Find the line assignment connector plugged into the logic board near the back of the set (Fig. 21). The visible side is labeled "LINES 1 & 2."
- (c) Carefully disconnect the line assignment connector from the logic board by pulling straight up until it clears the plastic guide block around the pins on the board.
- (d) Rotate the connector 180 degrees so that the side labeled "LINES 3 & 4" is visible.
- (e) Carefully plug the connector back into the logic board in its new position.
- (f) Plug the transformer and heat sink assembly back into the rear of the set. Tighten the two retaining screws.

B. CO/PBX Ringing and DSS Code Assignments (All Sets)

3.34 Located under the hinged cover on the DSS key of each station are four common audible switches which control CO/PBX ringing, and the DSS intercom code selection switch which determines the intercom code of the station (Fig. 22). Repeat the following procedure at each station.

(a) CO/PBX Ringing Assignments:

- (1) Raise the cover by pressing on the left end to tilt it up or pry up the right end with a fingernail.
- (2) Find out which CO/PBX lines are to ring at the station. Set the switch for each line either ON or OFF. On the standard DSS key (664B), ON is up and OFF is down; on the code busy DSS key (664C), ON is right and OFF is left. (Figure 22 shows the station coded to ring on lines 2 and 4.)

(b) DSS Code Assignments:

- (3) Find out which intercom code is to be assigned to the station. The following considerations and limitations should apply to code assignments.
 - If several stations are set for the same DSS code, they will all be voice signaled when that code is called.
 - The DSS codes can also be assigned to paging, supplementary alerting, and preset multiple signaling.
 - If the standard DSS key (664B) is used, the number of stations plus the number of options assigned to the same DSS code must not exceed 16.
 - If the code busy DSS key (664C) is used, the number of stations plus the number of options assigned to the same DSS code must not exceed 4.



Do not assign an HFAl station to the same code with any other station set, apparatus unit, or loudspeaker set.

- (4) To set the intercom code, slide the DSS intercom code selection switch to the proper number between 1 and 10 (or to OFF if the station is to have no DSS code). Be careful that the switch is not between detent positions. (Figure 22 shows the set coded as station 3.)
- (5) Close the switch cover.

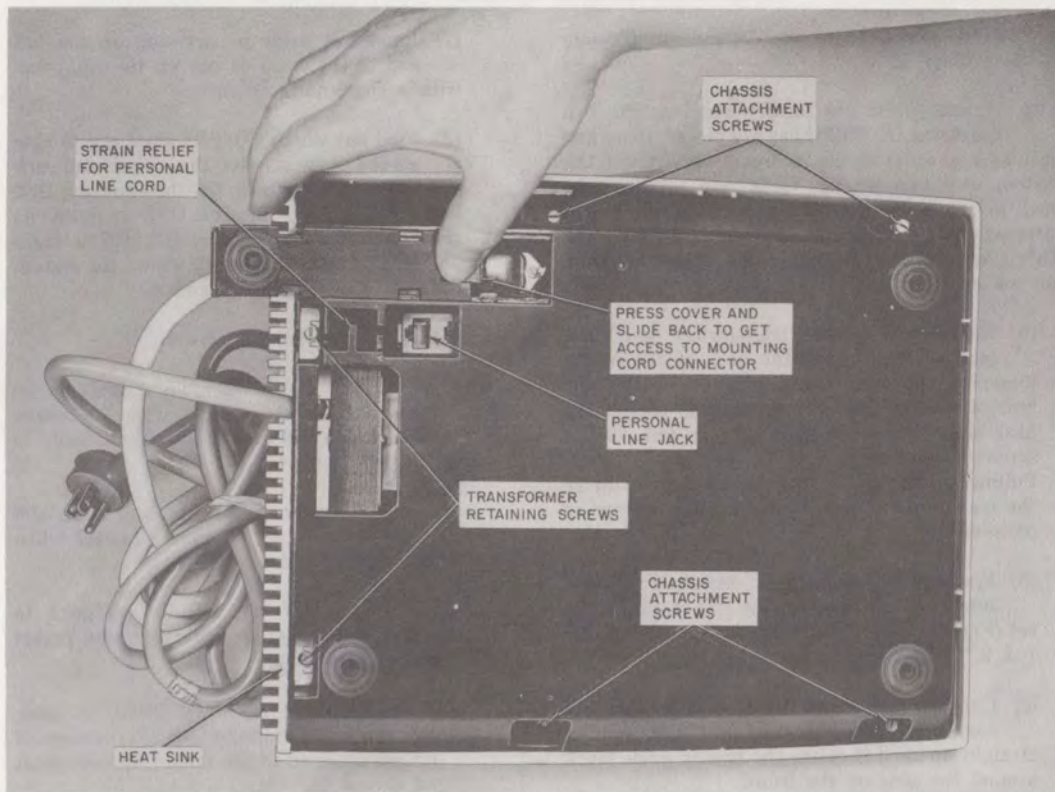

Fig. 20—Primary Set, Bottom View

SUPPLEMENTARY POWER

3.35 Mount the 19B4 power unit near the 184B2 backboard where the station cables are cut down (Fig. 8) and within available power cord length of a suitable ac outlet. Connect the 24V B SIG output to row 40 (S-Y) of a vacant column of one of the backboard connecting blocks and SIG GRD to row 39 (Y-S). Move the ac input tap from the 117-volt ac screw terminal to the 123-volt ac screw terminal. **Do not connect the power cord until all installation is complete.**



Do not connect power unit SIG GRD to building ground.

3.36 The primary sets are factory-wired to supply all system power from their internal power supplies. When a 19B4 power unit is added, make the following connector change in *each* primary station:

- (a) Open the back of the set by removing the transformer assembly as described in paragraph 3.33(a)
- (b) Find the power connector labeled SYS plugged into the logic board near the back of the set (Fig. 21)
- (c) Carefully disconnect the power connector from the logic board by pulling straight up



Fig. 21—Primary Set, Rear View With Heat Sink Removed

until it clears the plastic guide block around the pins on the board

- (d) Turn the connector around so that the side labeled SUPP shows
- (e) Carefully plug the connector block into the logic board in its new position
- (f) Replace the transformer assembly. Tighten the two retaining screws.

OPTIONAL FEATURES

Note: Refer to Part 5 for complete procedures for disassembling and assembling telephone sets.

A. Music-On-Hold

3.37 This option requires a customer-provided music source, installation of a D-180980 Kit of Parts in each primary set, and one 33C voice coupler per system. Music- and tone-on-hold (paragraph 3.41) **cannot** be installed in the same system.

3.40 Install the kit of parts in each primary set as follows:

- (a) Open the back of the set by removing the transformer assembly as described in paragraph 3.33(a).
- (b) Plug the circuit board connector into the keyed plug on the logic board (Fig. 21 and 23).
- (c) Insert the music-on-hold circuit board vertically in the slots in the housing and base (Fig. 21).
- (d) Replace the transformer assembly. Tighten the two retaining screws.

3.41 Install the 33C voice coupler as follows:

- (a) Remove the cover from the coupler.
- (b) Mount the coupler in some location where it can be conveniently connected to both the customer's music source and the 4A System.
- (c) Connect terminals 3 and 4 of the 33C coupler to the primary stations via the two M terminals of the 91B connecting blocks using inside wire (Fig. 24). Connect GRD terminal to building ground.
- (d) Replace the cover on the coupler.

Note: Music for lines 1 and 2 is connected through the 91B block for the first primary station, and music for lines 3 and 4 through the 91B block for the second primary.

- (e) Have the customer connect music source to terminals 1 and 2 on the outside of the coupler. (If customer's music source is not yet available, set the coupler potentiometer fully counterclockwise. Complete the installation when the music source is available.)



The customer-provided music source must be capable of providing 1 watt of undistorted RMS power into an 8-ohm load. In addition, the output of the music source must be ac coupled. Do not connect a source that has a dc voltage on the output.

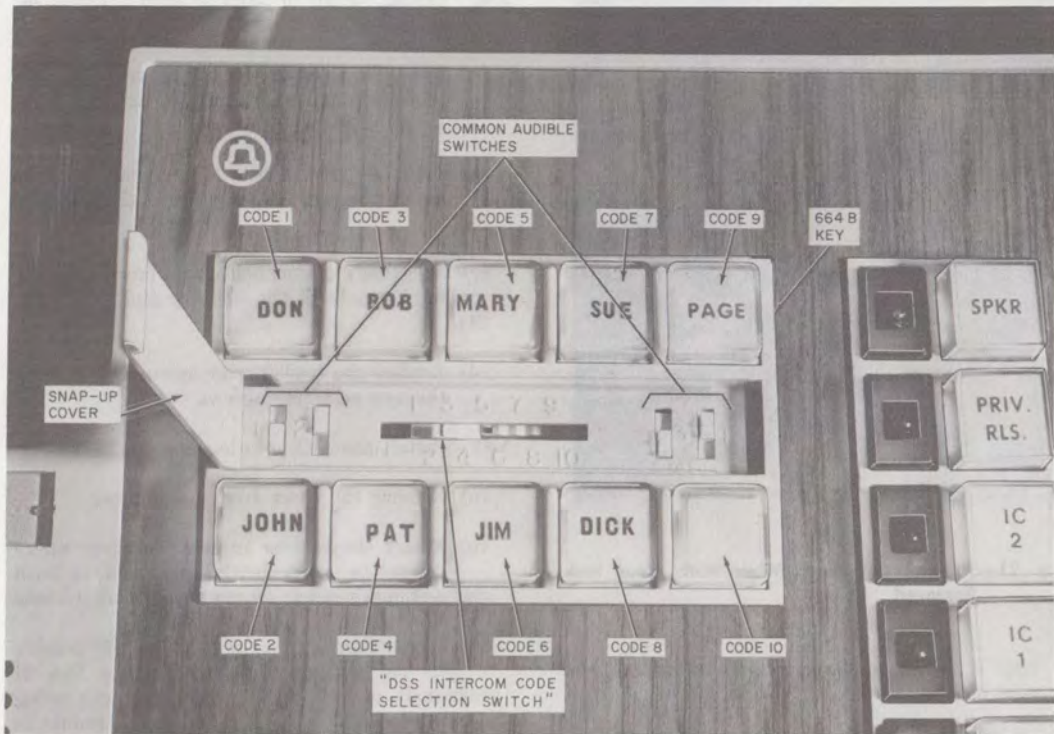

Fig. 22—DSS Key, Cover Open

The 33C voice coupler will accept input from any customer-provided apparatus that does not blow a fuse in the coupler.

- (f) After all installation is complete, adjust the music-on-hold circuit as described in paragraph 3.40.

3.40 Adjust the volume level of the music-on-hold as follows:

- (a) Place a call to one of the 4A System stations on a CO/PBX line
- (b) Answer the call and place it on hold

- (c) Have the customer adjust the music source for a comfortable listening level on the held line.

Note: Refer to paragraph 3.58(f) for installation of music-on-hold with a personal line.

B. Tone-On-Hold

- 3.41** This option requires the installation of a D-180731 Kit of Parts in each primary set. Tone- and music-on-hold cannot be installed in the same system. Install the kit of parts in each primary set in the same way as the music-on-hold kit (paragraph 3.38). After the installation is complete, test the tone-on-hold circuit as described in paragraph 3.42.

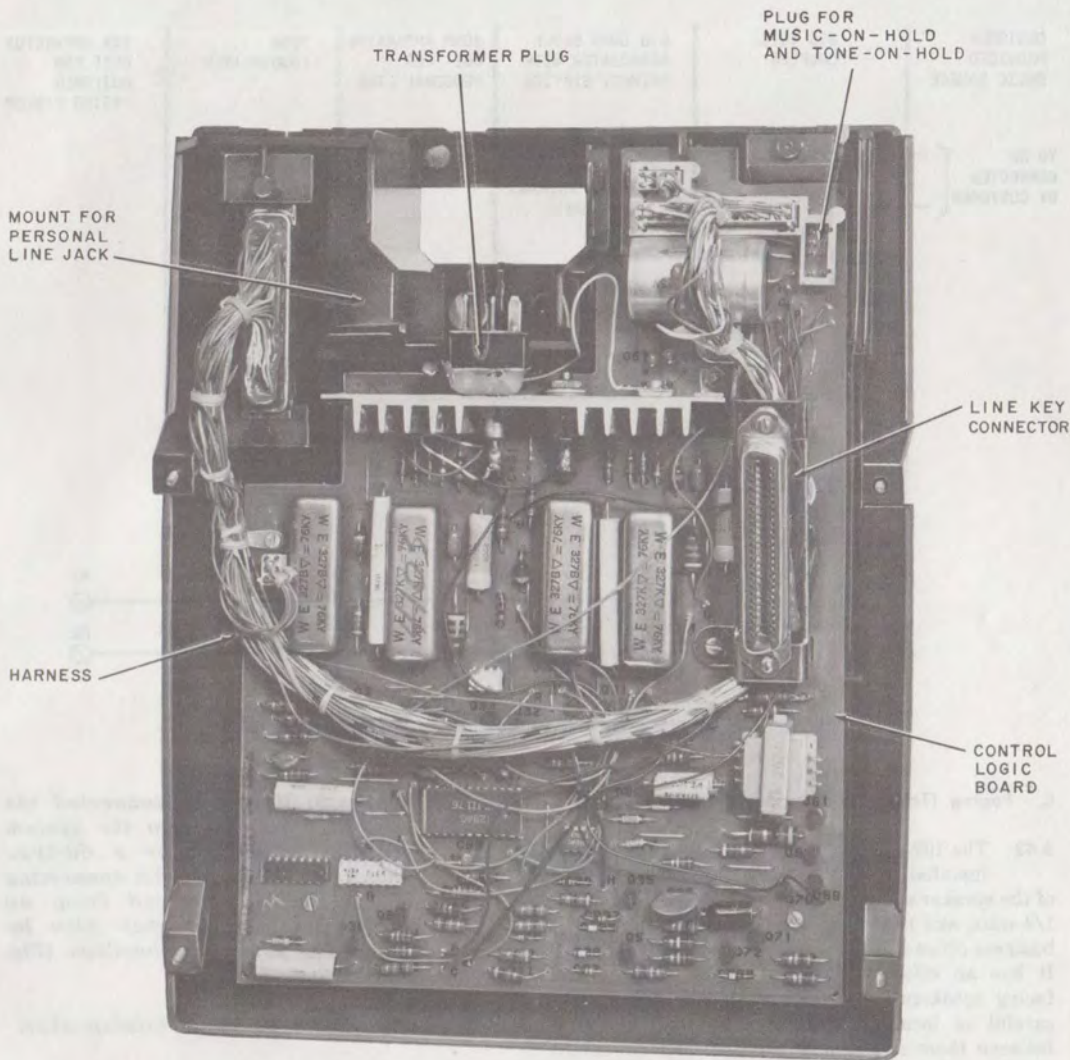

Fig. 23—Base and Logic Assembly of Primary Set

3.42 Test the tone-on-hold circuit as follows:

- (a) Place a call to one of the 4A System stations on a CO/PBX line
- (b) Answer the call and place it on hold

- (c) An intermittent tone at a comfortable level should be heard on the held line.

Note: Refer to paragraph 3.58(g) for installation of tone-on-hold with a personal line.

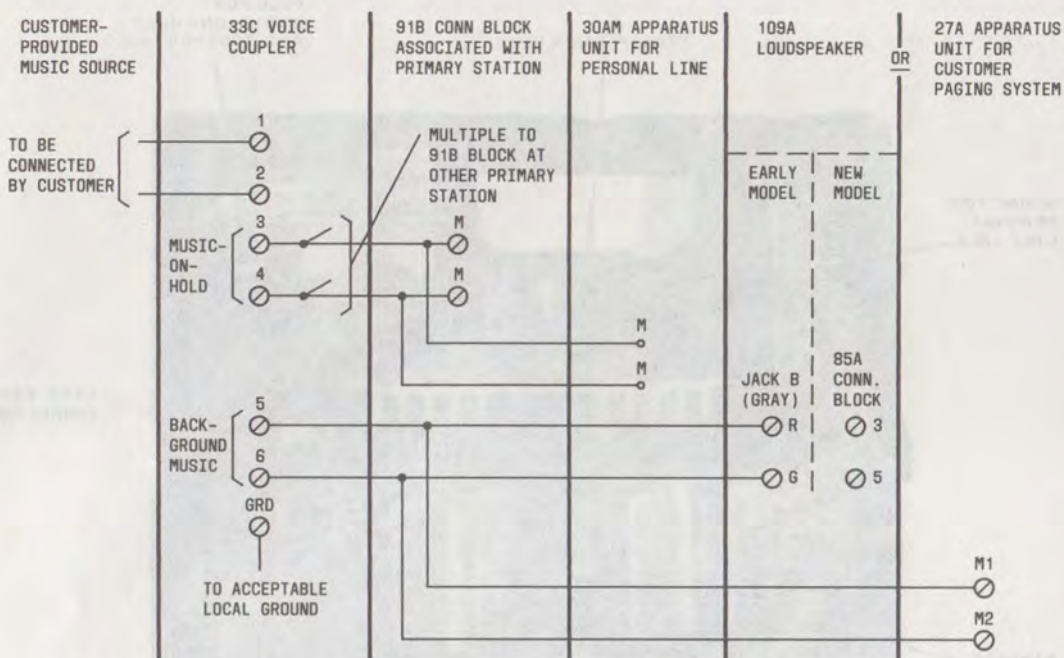

Fig. 24—Connections for Music-On-Hold and Background Music

C. Paging (Telephone Company Provided System)

3.43 The 109A loudspeaker is designed for indoor installation (above 32°F). The power output of the speaker at low +V potentials is approximately 1/4-watt, and therefore, is intended for the typical business office and not for high noise environments. It has an effective range of about 30 feet; use facing speakers in a room of greater width. Be careful to locate loudspeakers so that feedback between them and nearby stations does not occur during paging; spacing of up to 60 feet between loudspeakers and stations may be required. Avoid mounting loudspeakers so that they are pointed directly at stations. Refer to Fig. 25 for typical loudspeaker installations. Install and connect the loudspeaker as follows.



The loudspeaker is normally connected into the 4A System via the 91B blocks associated with each primary set (Fig. 26). However, if the speaker is to be located remote from either

primary, it can be connected via a 91B block cut into the system cabling (Fig. 26) or a 66-type block (Fig. 27). A 91A connecting block (MD) removed from an older installation may also be used for paging connections (Fig. 28).

(a) Early Model or 109A Loudspeaker:

- (1) Attach the wall bracket assembly of each loudspeaker directly to a suitable wall surface or device box (Fig. 29).
- (2) Find out which DSS code is to be assigned to paging. Using inside wire, connect the loudspeaker(s) as shown in Fig. 26, 27, or 28.
- (3) If background music is to be provided over the 109A loudspeaker, install a 33C voice coupler if one is not already used for

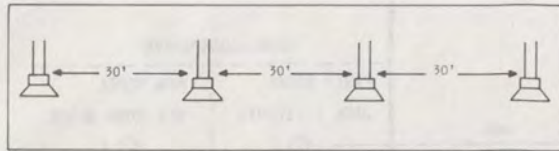

EXAMPLE A - SPEAKERS LOCATED ON ONE WALL OF ROOM (NOTES 1 AND 2)

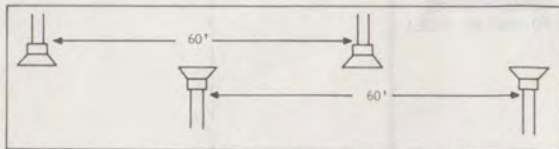

EXAMPLE B - SPEAKERS LOCATED ON OPPOSITE WALLS OF ROOM (NOTE 1)

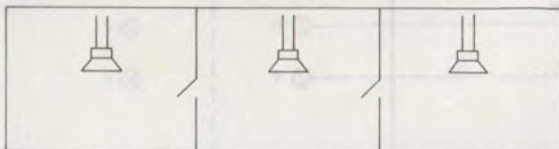

EXAMPLE C - SPEAKERS LOCATED IN INDIVIDUAL ROOMS (NOTES 1 AND 3)

NOTES:

1. EXAMPLES A, B AND C ARE FOR QUIET OR OFFICE TYPE ENVIRONMENTS. FOR A NOISY ENVIRONMENT, DISTANCE BETWEEN SPEAKERS MUST BE REDUCED TO A DISTANCE THAT WILL PROVIDE THE SAME LISTENING LEVEL. ALL SPEAKERS SHOULD BE LOCATED AT LEAST 60 FEET FROM ANY STATION USED FOR PAGING.
2. SPEAKERS REACH A DEPTH OF 30 FT. IF ROOM IS OVER 30 FT. WIDE, FACING SPEAKERS SHOULD BE USED.
3. ONE SPEAKER WILL SERVE A ROOM UP TO 25 FT. BY 25 FT.

Fig. 25—Examples of Loudspeaker Locations

music-on-hold (the same coupler can be used for both functions), and connect as shown in Fig. 24.

(4) While holding the loudspeaker up near the wall bracket, connect plug A into jack A of the bracket, and plug B into jack B, ivory to ivory and gray to gray, respectively.

(5) Slip the speaker baffle mounting bracket over the mounting clips on the wall bracket assembly and push the speaker down until it is firmly held.

(6) After all installation is complete, adjust and test each loudspeaker as described in paragraph 3.44.

(b) **New Model of 109A Loudspeaker:**

(1) The loudspeaker set is shipped completely assembled. Loosen the two locking screws on the bottom of the loudspeaker set and separate the wall bracket from the baffle

(Fig. 30). Unplug the D8W cord from the 85A block.

(2) Attach the wall mounting bracket to a suitable wall surface or device box with four No. 8 screws; place the four rubber washers supplied with the set between the bracket and the mounting surface. All outside connections to the loudspeaker will be made at the screw terminals of the 85A block attached to the plate.

(3) Find out which DSS code is to be assigned to paging. Using inside wire, connect the loudspeaker(s) as shown in Fig. 26, 27, or 28.

(4) If background music is to be provided over the 109A loudspeaker, install a 33B voice coupler if one is not already used for music-on-hold (the same coupler can be used for both functions) and connect as shown in Fig. 24.

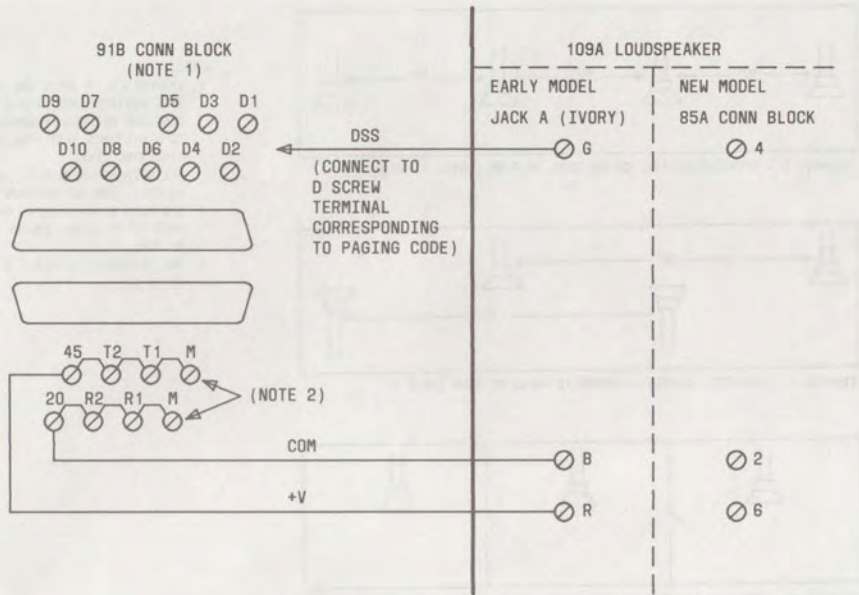

NOTES:

1. CONNECTIONS CAN BE MADE AT A 91B BLOCK SERVING ONE OF THE PRIMARY STATIONS OR A 91B BLOCK INSERTED IN SYSTEM CABLING SPECIFICALLY FOR USE WITH LOUDSPEAKER.
2. STRAP ADJACENT TERMINALS AS SHOWN ONLY IF 91B BLOCK IS NOT ASSOCIATED WITH PRIMARY STATION.

Fig. 26—Paging Connections Using 91B Connecting Block

(5) While holding the loudspeaker baffle up near the wall bracket, plug the free end of the D8W cord into the modular jack of the 85A block (Fig. 30).

(6) Mount the loudspeaker baffle on the wall bracket by hooking the two pins on the inner sides of the baffle into the two mounting slots of the wall bracket. Press the baffle down against the bracket so that the two slots in the lower edge of the baffle fit over the two locking screws of the wall bracket; tighten the screws.

(7) After all installation is complete, adjust and test each loudspeaker as described in paragraph 3.44.

3.44 Adjust and test the paging system as follows:

- (a) If background music is provided, adjust the volume control of the 33C voice coupler to mid-range. Adjust the right-hand volume control of each loudspeaker for the desired music level. The volume control of the 33C may be readjusted if necessary to raise or lower the overall music level.



If music-on-hold was previously installed, do not readjust the music level at the customer-provided source.

- (b) At any station in the 4A System, select an idle intercom path and hold down the DSS button assigned to the paging system. While

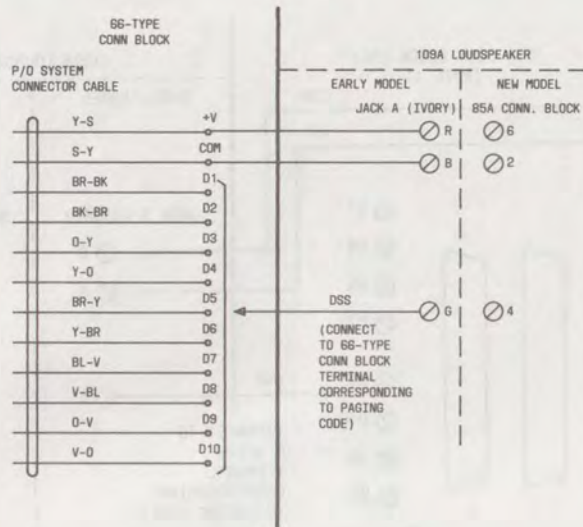

Fig. 27—Paging Connections Using 66-Type Connecting Block

speaking into the handset in a normal voice, have the left-hand volume control on each loudspeaker adjusted to the output level desired by the customer. Background music will be muted while the system is used for paging.

D. Paging (Interface With Customer-Provided System)

3.45 The 27A apparatus unit (Fig. 31) has terminals for connection to the 4A System and the customer equipment; put it where there is convenient access to both. It must be located indoors where the temperature is always above 32°F.

- Remove the cover and mount the base pan assembly of the 27A in the desired location so that terminals A1 and A2 are easily accessible by the customer.
- Find out which DSS code is to be used to access the paging system. On the 27A, remove the lead corresponding to the code from the numbered push-on terminal where it is stored and insert it into the IN terminal.
- If background music is to be provided, install a 33C voice coupler if one is not already used for music-on-hold (one coupler will serve

both functions). Connect screw terminals 5 and 6 of the coupler to screw terminals M1 and M2 of the 27A unit (Fig. 24 and 31). Connect GRD terminal to building ground.

- If the customer paging system requires a contact closure when the paging occurs, install a KS-16626L12 relay set per Section 463-120-100. Connect the relay coil circuit to screw terminals R1 and R2, and connect a strap between screw terminals R3 and R4.
- Plug in the system cable or cables. Position inserts inside cover to hold cable(s) securely when cover is replaced.
- Replace cover.
- Have customer paging system connected to screw terminals A1 and A2.
- After all installation is complete, adjust and test the paging system as described in paragraph 3.44, except that loudspeaker output level adjustments are to be made by the customer on the customer's own units. If the customer

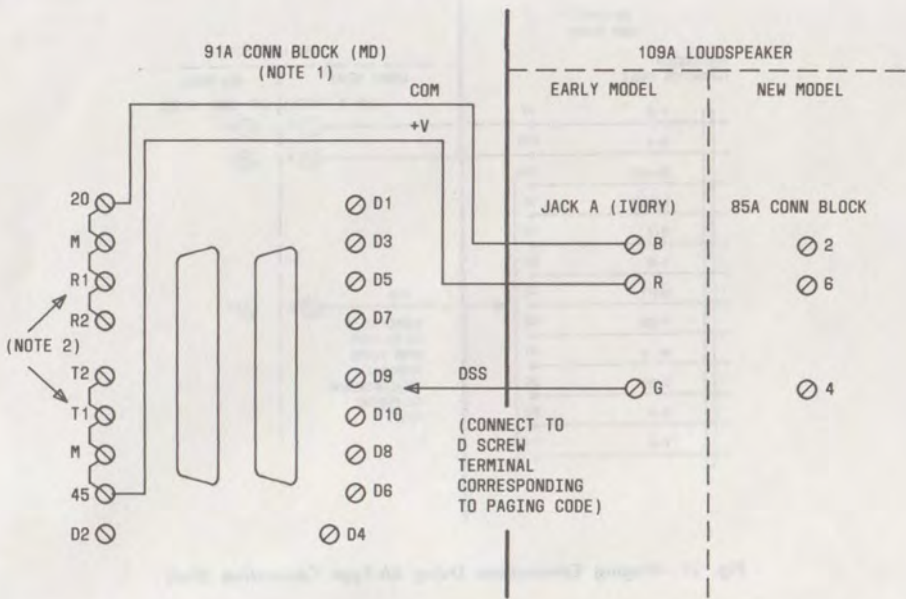

NOTES:

1. CONNECTIONS CAN BE MADE AT A 91A BLOCK SERVING ONE OF THE PRIMARY STATIONS OR A 91A BLOCK INSERTED IN SYSTEM CABLING SPECIFICALLY FOR USE WITH LOUDSPEAKER.
2. STRAP ADJACENT TERMINALS AS SHOWN ONLY IF 91A BLOCK IS NOT ASSOCIATED WITH PRIMARY STATION.

Fig. 28—Paging Connections Using 91A (MD) Connecting Block

paging equipment is not available, a 107A loudspeaker can be substituted temporarily:

- (1) Connect the red and green leads of the 107A to A1 and A2, respectively.
- (2) Connect the yellow and brown leads of the 107A to a 2012D power transformer plugged into a suitable ac outlet.

E. Power Failure Ringing

3.46 Locate the 24B apparatus unit (Fig. 32) near the telephone where power failure ringing is required. Remove the cover and mount the base pan assembly on a vertical surface so that the mercury relay on the wiring board is in a

vertical position as indicated by the arrows on the relay can.

3.47 Both the 24B apparatus unit and the earlier 24A (MD) are factory-wired to provide power failure ringer service for CO/PBX lines 1 and 2. Internal wiring changes are required for use with lines 3 and 4. Connect the apparatus unit as described in (a) or (b).

(a) **24B Apparatus Unit**—In addition to the system cables, connections must be made with inside wire between the 24B and the 91B connecting block associated with the primary set or between the 24B and the network interface with a modular cord.

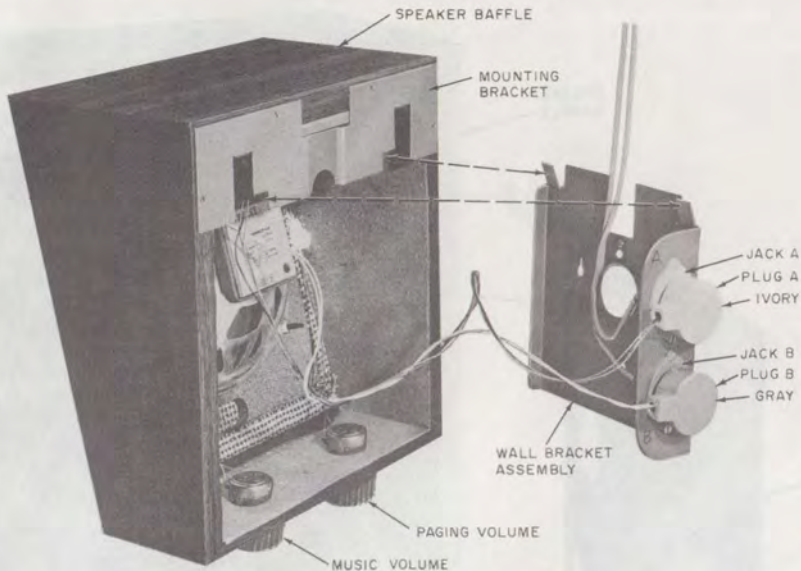

Fig. 29—109A Loudspeaker Set (Early Model)

(1) If the 24B is to be used with lines 1 and 2, either connect it with inside wire to the 91B block associated with the primary set where lines 1 and 2 are controlled or use a D4BU cord (25-foot maximum) to connect it directly to the network interface (Fig. 33). Skip to Step (3).

(2) If the 24B is to be used with lines 3 and 4, move the O (orange) lead from screw terminal 1-2 to 3-4 (do not disconnect any other leads). Either connect the 24B with inside wire to the 91B connecting block associated with the primary set where lines 3 and 4 are controlled or use a D4BU cord (25-foot maximum) to connect it directly to the network interface (Fig. 33).

(3) Remove the cable clamp(s) and plug in the system cable(s). Replace the clamp(s) using the tapped hole in the base pan or standoff to hold the cable securely.

(4) Replace the cover.

(5) Test the power failure ringing as described in paragraph 3.48.

(b) **24A Apparatus Unit (MD)**—All external connections are provided through the system cables.



After the FCC register-only date, only those 24A apparatus units which have been removed from other installations may be used.

(1) If the 24A is to be used with lines 1 and 2, go directly to Step (4).

(2) If the 24A is to be used with lines 3 and 4, disconnect, insulate, and store the five leads connected to terminals 4, 5, 6, 7, and 9 on the wiring board (do not disconnect the lead on terminal 8). Perform Step (3).

(3) Connect the five factory-insulated and stored leads to the vacant terminals as follows:

O-R to terminal 5
 R-O to terminal 4
 Y-G to terminal 6
 R-S to terminal 9
 S-R to terminal 7

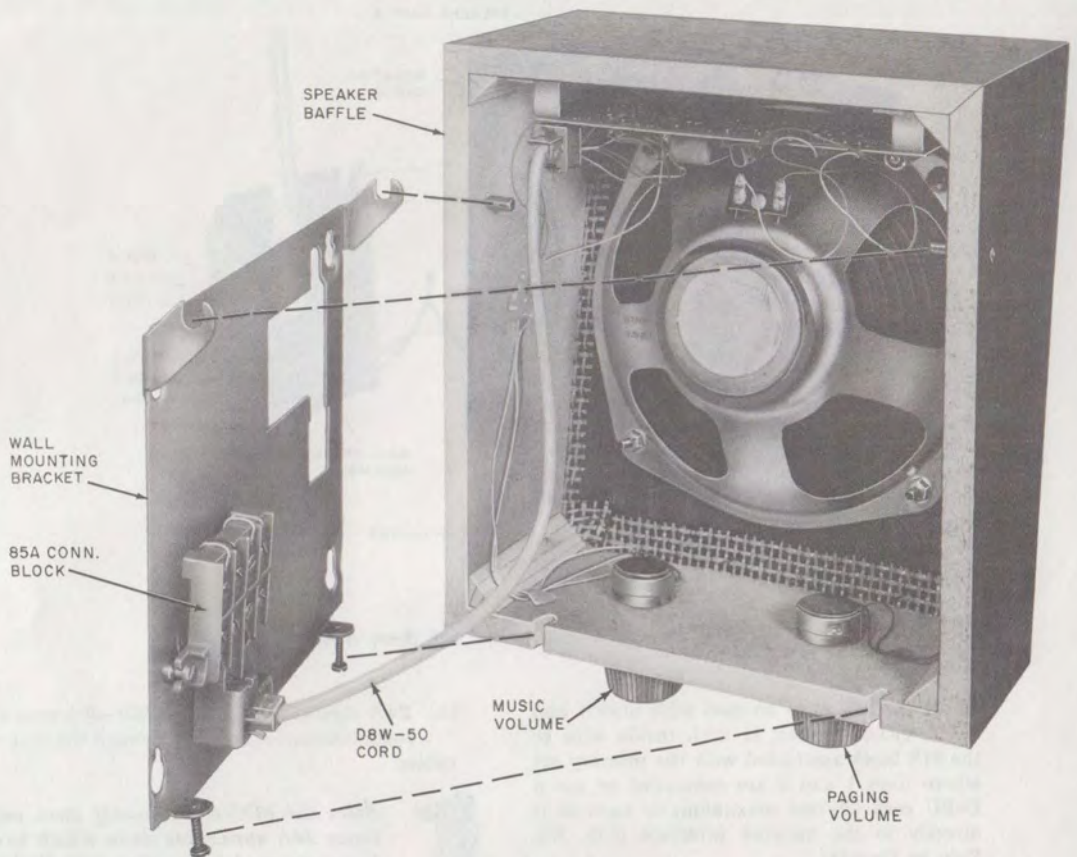

Fig. 30—109A Loudspeaker Set (New Model)

Note: A 24A apparatus unit wired for lines 3 and 4 can be rewired for lines 1 and 2 by disconnecting, insulating, and storing the five leads connected in (3) and then connecting the previously stored leads as follows:

BL-W to terminal 5
 W-BL to terminal 4
 BK-S to terminal 6
 W-BR to terminal 9
 BR-W to terminal 7

(4) Remove the cable clamp(s) and plug in the associated system cable(s). Replace

the clamp(s) using the tapped hole in the base pan or standoff to hold the cable(s) securely.

(5) Replace the cover.

(6) Test the power failure ringing as described in paragraph 3.48.

3.48 Test the power failure ringing as follows:

(a) Unplug the ac line cord of the primary set serving CO/PBX lines 1 and 2.

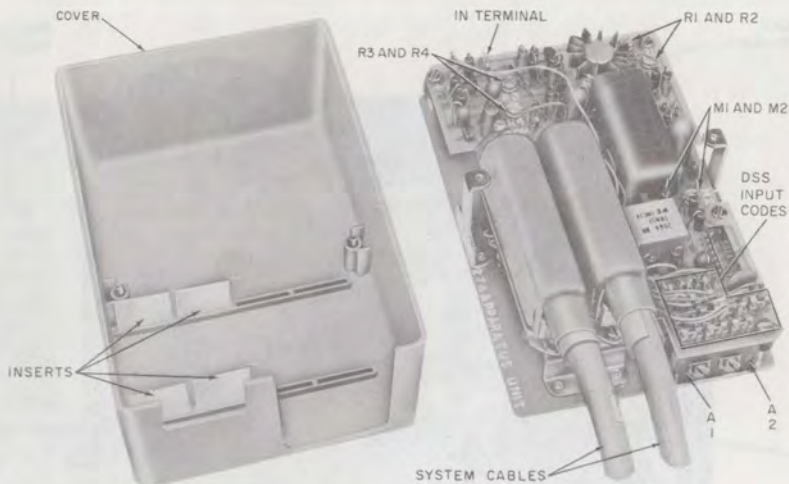

Fig. 31—27A Apparatus Unit

- (b) Place a call into the system on line 1. The power failure ringer should ring. Repeat for line 2.
- (c) Plug the ac line cord back into its receptacle.
- (d) Again place calls into lines 1 and 2. The power failure ringers should not ring.
- (e) If applicable, repeat above procedure for lines 3 and 4 at the second primary station to test the 24A or 24B apparatus unit associated with it.
- (f) If supplementary power is used and 24B apparatus units are installed, perform one additional test. Unplug the 19B4 power unit and again place calls to each line in the system; the appropriate power failure ringers should operate.
- (b) To provide a relay for the auxiliary signaling, mount a KS-16626L12 relay set per Section 463-120-100 or a KS-16301L17 relay set per Section 463-110-100.
- (c) Connect terminals 1 and 2 of the 25A to the coil of the auxiliary relay and connect the auxiliary signal to the relay per the applicable section listed in (b).
- (d) If the auxiliary signal is to respond to a DSS code, move the spade-tip lead associated with that code from storage terminal 1 through 10 on the 25A unit to the IN terminal.
- (e) If the auxiliary signal is to respond to any combination of common audible signals, move the spade-tip leads associated with the lines from storage terminals CA 1 through 4 to terminals A through D.

Note: The 25A apparatus unit can be coded to respond to both a DSS code and up to four common audible signals.

F. Supplementary Alerting Device Access

3.49 Install a 25A apparatus unit (Fig. 34) and an auxiliary signal as follows:

- (a) Remove the cover of the 25A and mount the base pan assembly at the desired location.
- (f) Plug in system cable or cables. Position inserts inside cover to hold cable(s) securely when cover is replaced.

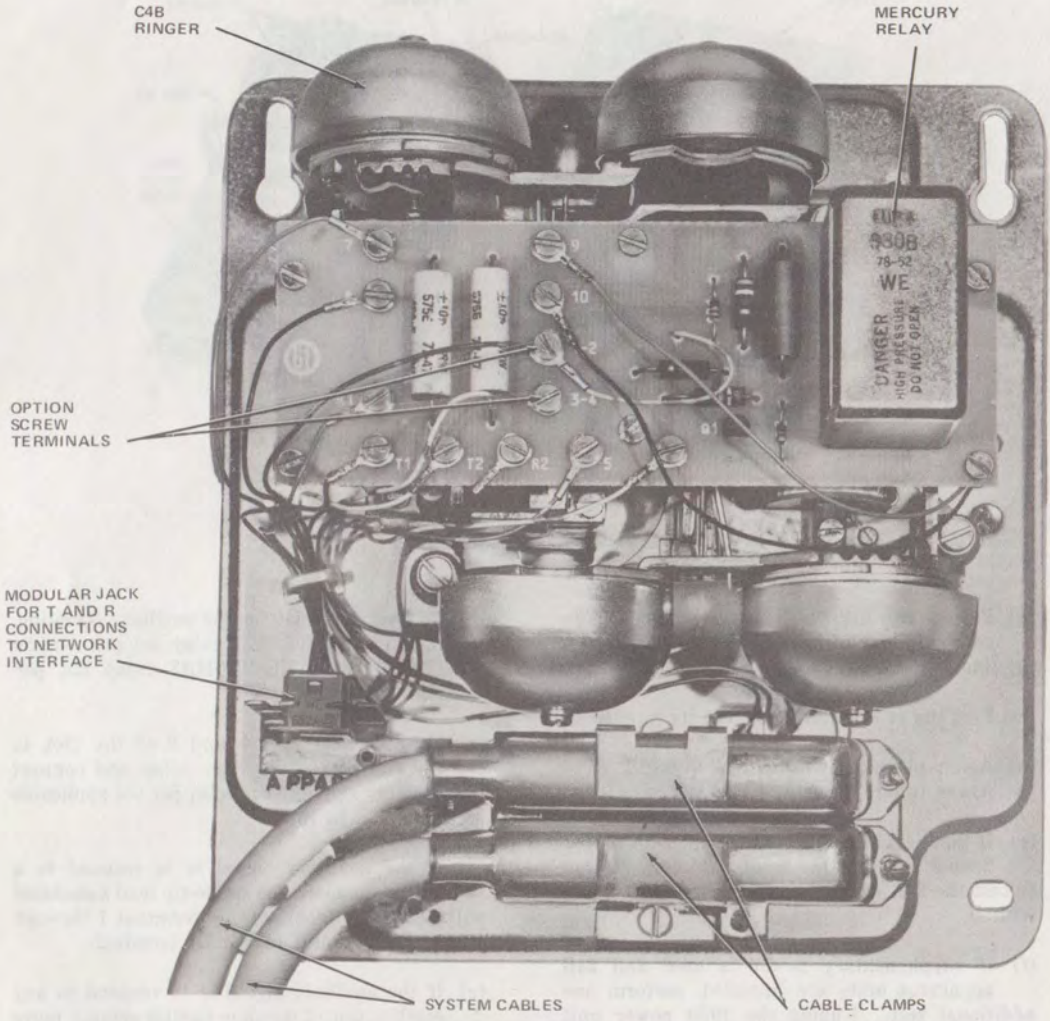

Fig. 32—24B Apparatus Unit

(g) Replace cover.

(h) When all installation is complete, test the supplementary alerting as described in paragraph 3.50.

3.50 Test the supplementary alerting as follows:

(a) If the auxiliary signal is connected to respond to a DSS code, depress that DSS button at any station to operate the signal. It should

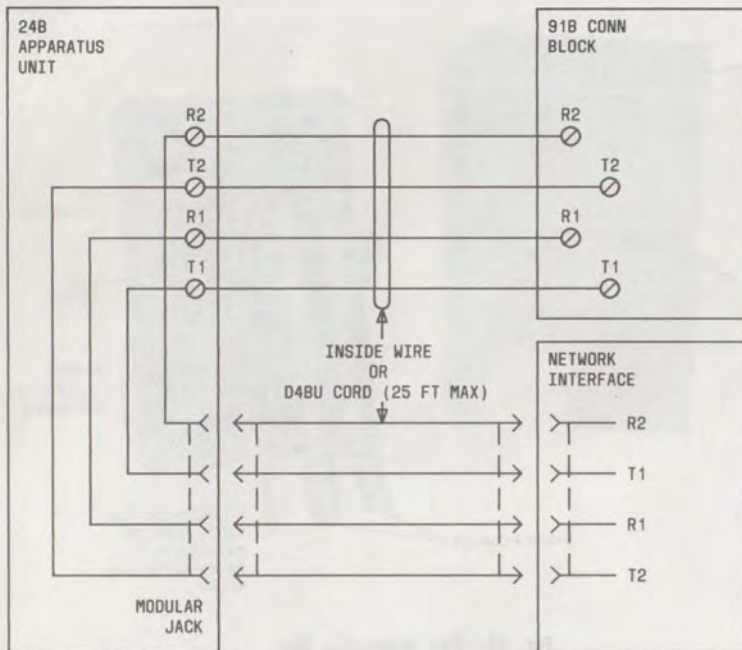

Fig. 33—Two Methods of Connecting 24B Apparatus Unit to CO/PBX Lines for Power Failure Ringing

continue to operate as long as the button is depressed.

Note: It is not necessary to use the handset or to select an intercom path for supplementary alerting via DSS code.

(b) If the auxiliary signal is to respond to common audible signals, place calls to the appropriate lines. The auxiliary signal should follow the normal CO/PBX ringing pattern.

G. Preset Intercom Voice Signaling

3.51 Install a separate 26A apparatus unit (Fig. 35) for each preset signaling group.

(a) Remove the cover and mount the base pan assembly in the desired location. It should be located indoors where the temperature is always above 32°F.

(b) Find out which DSS code will be used to access the input for multiple signaling and which DSS codes are to be called simultaneously.

(c) Remove the lead corresponding to the input code from the numbered storage terminal (1 through 10) and insert it into the IN terminal.

(d) Remove the leads corresponding to the called codes from the numbered storage terminals (1 through 10) and insert each one into a separate lettered output terminal (A through J). **If possible, do not use adjacent terminals; this will prevent shorted terminals.**



An HFAI station can be voice signaled via a 26A, but the HFAI circuit will not seize the line to permit hands-free answer.

(e) Plug in the system cable or cables. Position the inserts inside the cover to hold the

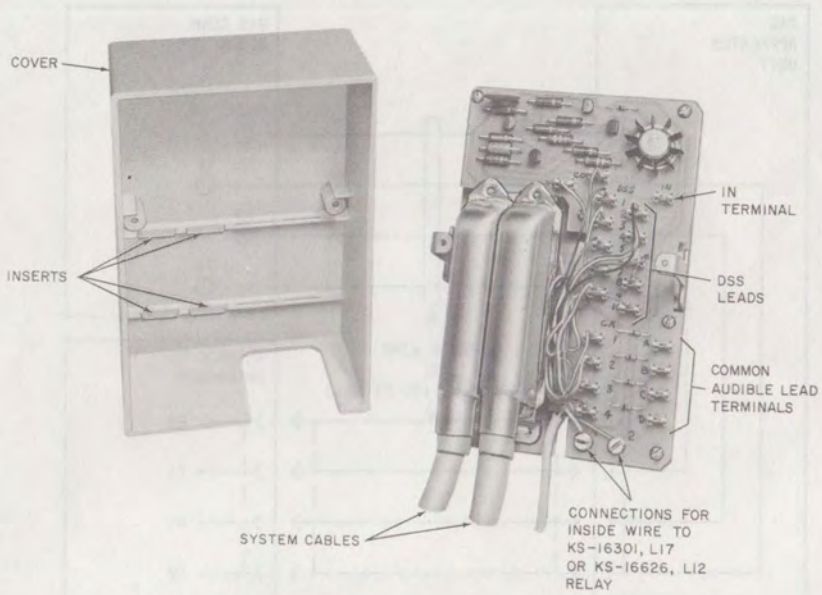

Fig. 34—25A Apparatus Unit

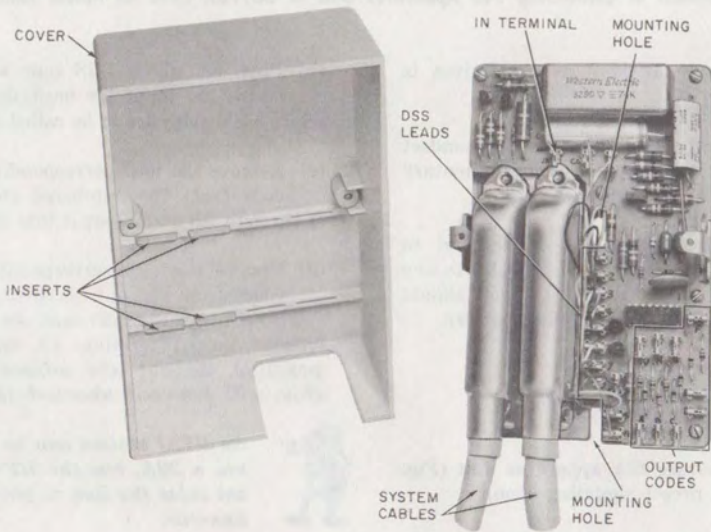

Fig. 35—26A Apparatus Unit

cables securely in place when the cover is replaced.

- (f) Replace the cover.
- (g) When all installation is complete, test the preset signaling as described in paragraph 3.52.

3.52 Test *each* preset signaling code as follows:

- (a) At an idle telephone, adjust the loudspeaker volume control to maximum and set the DSS programming switch to DSS code 1.

Note: The SPKR button must be in the released (up) position.

- (b) Select and depress an idle intercom line button. Depress and hold the DSS button corresponding to the input code of the 26A apparatus unit and speak into the handset. Speech shall be heard from the loudspeaker in the station set if the 26A apparatus unit is coded to access the zone coded in (a).
- (c) Repeat (a) and (b), moving the DSS selector switch through the remaining DSS zones.
- (d) If an HFAI station is in the preset signaling group, check to be sure that the HFAI circuit does not seize the line.
- (e) Return the DSS programming switch to its assigned station code position.

H. Privacy

3.53 This option requires the installation of a D-180729 Kit of Parts (privacy board) at each station to be locked out and the designation of the privacy release button in *all* stations in the system.

- (a) Remove the faceplate and upper housing of the telephone set to gain access to the area where the privacy board is to be mounted (see paragraphs 5.07 and 5.10).
- (b) Mount the privacy board in the lower left corner of the chassis by sliding it into the two notches with its relay to the right (Fig. 36).

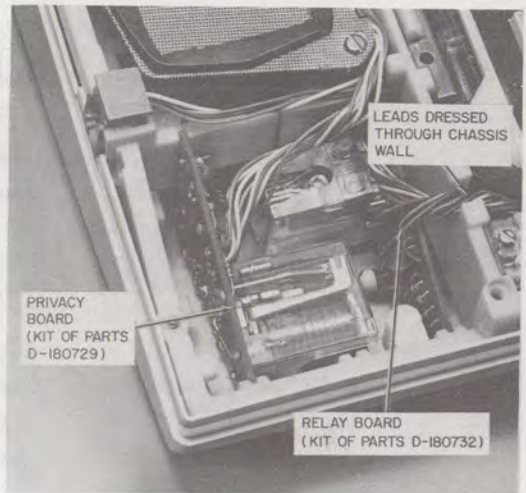
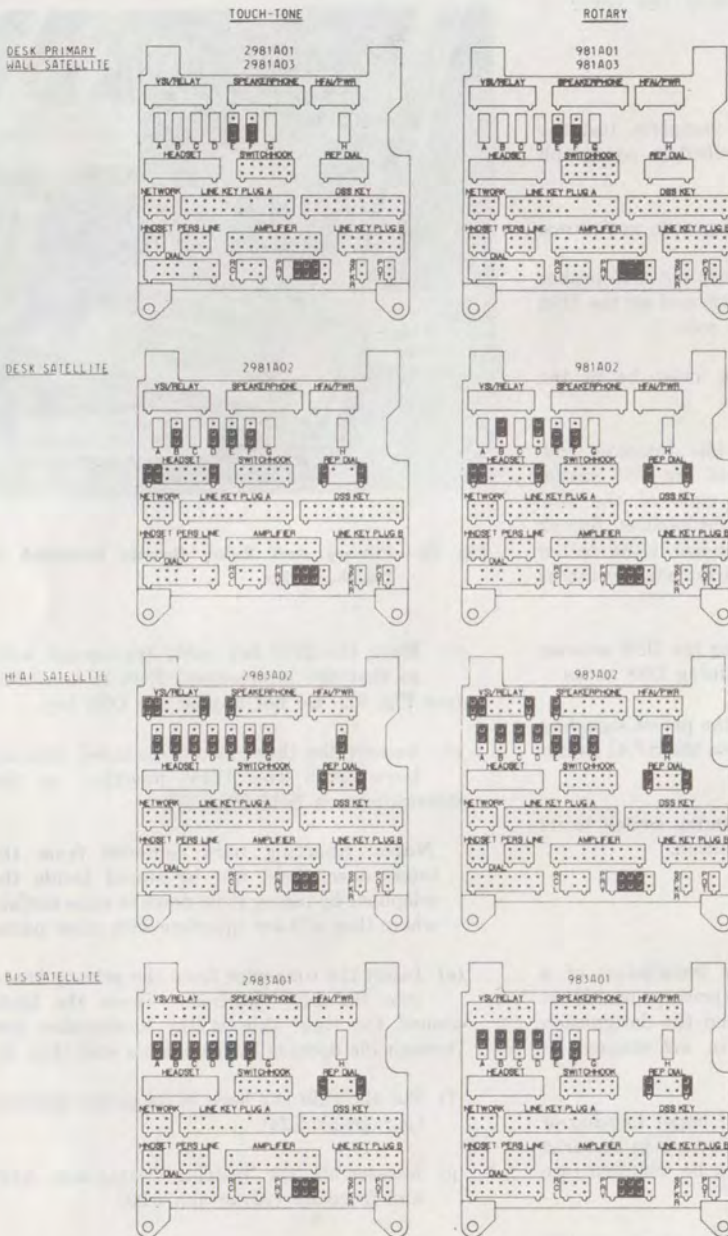



Fig. 36—Privacy and Relay Boards Installed in Telephone Set

- (c) Move the DSS key aside (paragraph 5.23) so that the interconnect field is accessible (see Fig. 5). Do not unplug the DSS key.
- (d) Remove the three factory-installed shorting bars from the PRV position in the interconnection field (Fig. 37).

Note: Shorting bars removed from the interconnect field can be stored inside the telephone by taping them down to some surface where they will not interfere with other parts.

- (e) Insert the connector from the privacy board into the PRV position. Dress the leads around the right side of the loudspeaker and through the opening in the chassis wall (Fig. 5).
- (f) Put the DSS key back in its proper position (paragraph 5.24).
- (g) Reassemble the housing (paragraph 5.12) and faceplate (paragraph 5.09).
- (h) Install the PRIV RLS designation tab in the privacy release button of *every* set in the system.



LEGEND:
 SHORTING BAR IN
 FACTORY-INSTALLED
 POSITION

NOTE:
 EXTRA SHORTING BARS
 ARE AVAILABLE IN KIT
 OF PARTS D-180828

Fig. 37—Interconnect Fields Showing Factory Positions of Shorting Bars

- (i) After all installation is complete, test the privacy feature in each station as described in paragraph 3.54.



If the privacy feature is ever removed from a set, be sure to restore the shorting bars removed in (d) to their original factory positions (Fig. 37). If the privacy feature is removed from all sets in the system, remove the PRIV RLS designation tabs from all sets.

3.54 Test the privacy feature as follows:

- At a second station in the 4A System, pick up an idle CO/PBX line.
- At the first station where privacy is being tested, try to pick up the same line. This station should be locked out, as evidenced by lack of sidetone.
- At the first station being tested, select an idle line. Then quickly return to the busy line. The station should still be locked out.
- Operate the PRIV RLS button at the second station while the second station is off-hook on the busy line. This should permit the first station to bridge onto the busy line.

I. Station Dial Restriction

3.55 This feature requires an internal wiring change at each station which is to be prevented from dialing out.

- Remove the faceplate from the telephone set (paragraph 5.07).
- Move the DSS key aside so that the interconnect field is accessible (paragraph 5.23). Do not disconnect the DSS key.
- At switches E and F on the interconnect field (Fig. 37), move the shorting bar from the lower position to the upper position.
- Put the DSS key back in its proper position (paragraph 5.24).
- Replace the faceplate (paragraph 5.09).

- (f) After all installation is complete, test dial restriction at each equipped station by attempting to place an outgoing CO/PBX call; it should be impossible to break dial tone.

Note: At a station equipped with both dial restriction and a repertory dial, outgoing calls can be made using the repertory dial.

J. Personal Line

3.56 The method of installation and connection of this feature depends on the type of telephone with which the line is used. In all cases, a 30AM apparatus unit (Fig. 38) must be installed for each personal line; a single 30AM can serve a maximum of 16 stations on the same line if the restrictions of Fig. 12 are observed.

3.57 The 30AM is a line circuit; the CO/PBX tip and ring leads of the personal line are connected to it via a D4BU cord from the network interface. Six station leads from the 30AM unit must be connected to the associated telephone(s) via a connecting block, a cord, a jack assembly, and mounting hardware provided in the D-180758 Kit of Parts which must be installed with all telephones, except BIS satellite sets, which are to have a personal line. The BIS sets already have the necessary internal wiring as part of their built-in speakerphone feature.



There is no common audible switch under the DSS key cover for the personal line. Any set wired to the 30AM will ring on that line. To disable the ring signal, disconnect the CA lead either at the 66-type block on the 30AM or at screw terminal 6 of the 85A or 86A connecting block associated with the set.

3.58 Install and connect the 30AM apparatus unit and the 86A connecting block as follows:

Note: In the case of BIS sets, installation of the 86A block has already been accomplished as part of the initial installation (paragraphs 3.21 and 3.27).

- Install a 30AM apparatus unit in a place which is convenient to both the incoming CO/PBX personal line and the station(s) served,

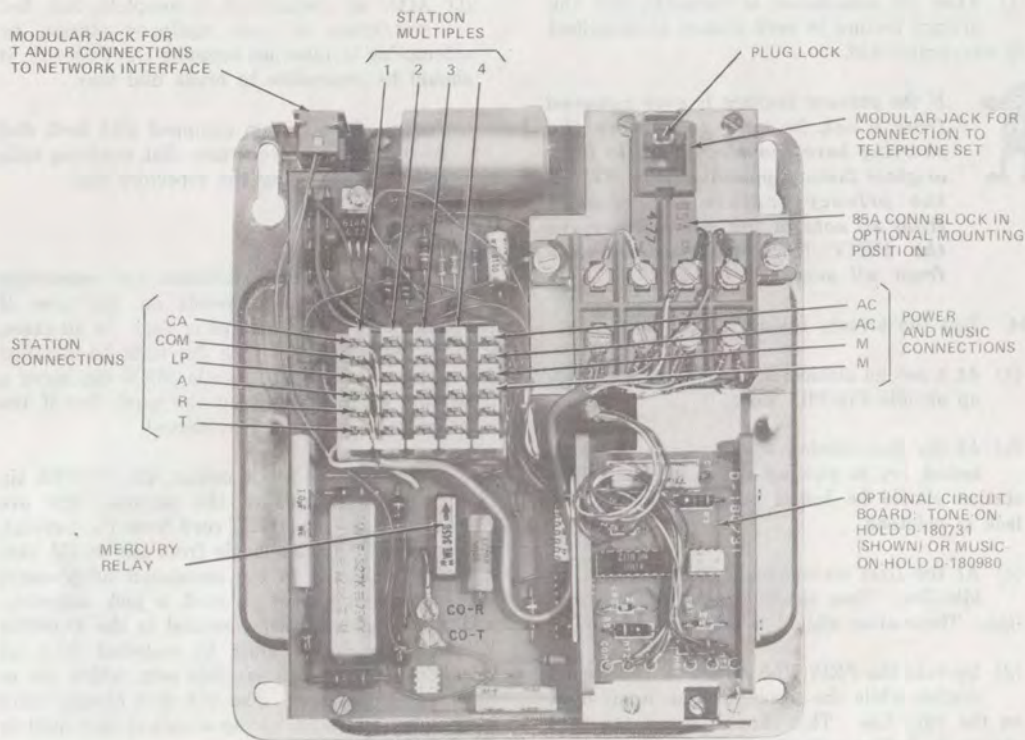

Fig. 38—30AM Apparatus Unit

and close to a suitable ac outlet. Remove the cover and mount the base pan assembly on a vertical surface so the mercury relay on the printed wiring board (Fig. 38) is in a vertical position as indicated by the arrow on the can.

(b) Using inside wire, connect the ac terminals of the 66-type block on the 30AM to the 95B1 power unit supplied with it (Fig. 39 and 40). **Do not plug the 95B1 into its assigned ac outlet until all installation is complete.**

(c) For *each* desk set served by the line, install the 86A connecting block supplied in a D-180758 Kit of Parts or with BIS sets within D8W cord length of the set.

Note: If the 30AM apparatus unit is also to be installed within D8W cord length of

the set, the 86A block can be disassembled as described in paragraph 3.58(d)(1) and its 85A block mounted directly on the 30AM unit (Fig. 38). Be sure that the white plastic plug lock is not removed from the modular jack of the 85A.

(d) For *each* wall set, the 86A block must be converted to an 85A and mounted on the wall plate as follows:

(1) Using a screwdriver, carefully pry the 85A connecting block portion away from the mounting cover. (The cover will not be used.)

(2) Remove the white plastic plug lock from the jack so that a D8W cord plug cannot be locked into the jack.

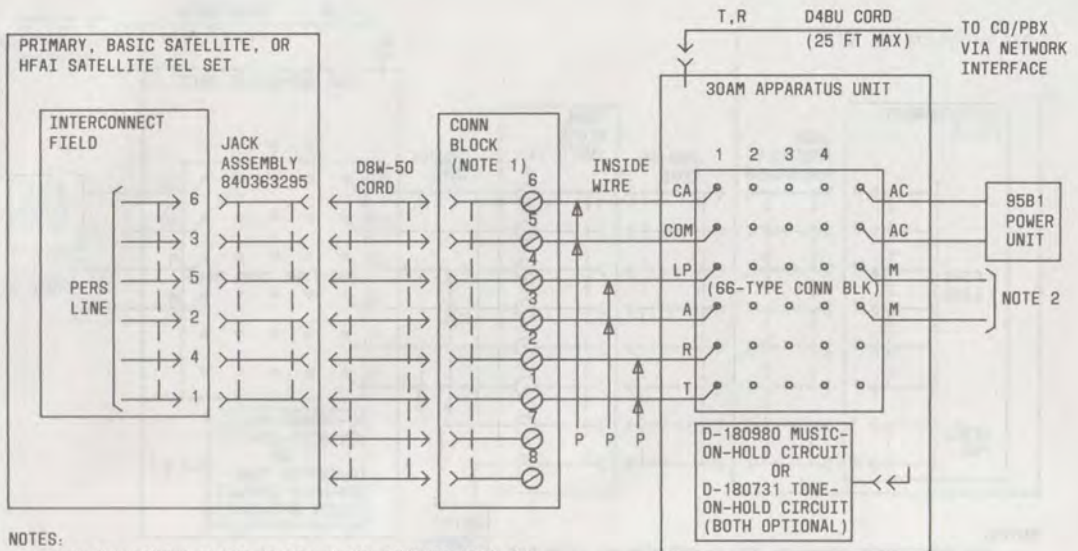

NOTES:

1. 86A CONNECTING BLOCK OR 85A BLOCK REMOVED FROM 86A AND MOUNTED ON WALL PLATE OR ON 30AM APPARATUS UNIT.
2. FOR MUSIC-ON-HOLD, CONNECT TO SAME 33C VOICE COUPLER USED WITH LINES 1-4 AND INSTALL D-180980 CIRCUIT BOARD. FOR TONE-ON-HOLD, NO EXTERNAL CONNECTIONS REQUIRED; INSTALL D-180731 CIRCUIT BOARD

Fig. 39—Personal Line Connections for Primary, Basic Satellite, or HFAI Set Using 30AM Apparatus Unit

Warning: If the plug lock is not removed, the D8W cord plug will lock into the 85A block when the telephone is attached to the wall plate, and it will be extremely difficult to remove the telephone again.

- (3) Mount the 85A block on the wall mounting plate with the two screws supplied with the plate.
- (e) Using inside wire, connect the 66-type block on the 30AM to the screw terminals of the 85A or 86A block associated with the station on the personal line (Fig. 39 and 40). Up to three additional stations may be connected **directly** to the 30AM. If more stations are to be added to the line, bridge them across the 86A blocks or use an external 66-type block for a common connection point. **Be sure to observe the cabling restrictions for personal lines described in paragraph 3.16 and Fig. 12.**

(f) If music-on-hold is to be provided on the personal line, install the circuit board from a D-180980 Kit of Parts in the slots on the front of the 30AM unit and plug in its connector. Using inside wire, connect the two M terminals on the 66-type block to terminals 3 and 4 of the same 33C coupler used with the common CO/PBX lines (Fig. 24, 39, and 40).

(g) If tone-on-hold is to be provided on the personal line, install the circuit board from a D-180731 Kit of Parts in the slots on the front of the 30AM unit and plug in its connector.

3.59 Make the connection between the 86A block and the telephone as follows.

(a) **Primary Stations (Fig. 39):**

- (1) Separate the upper housing and chassis assembly from the base of the set as described in paragraph 5.19.

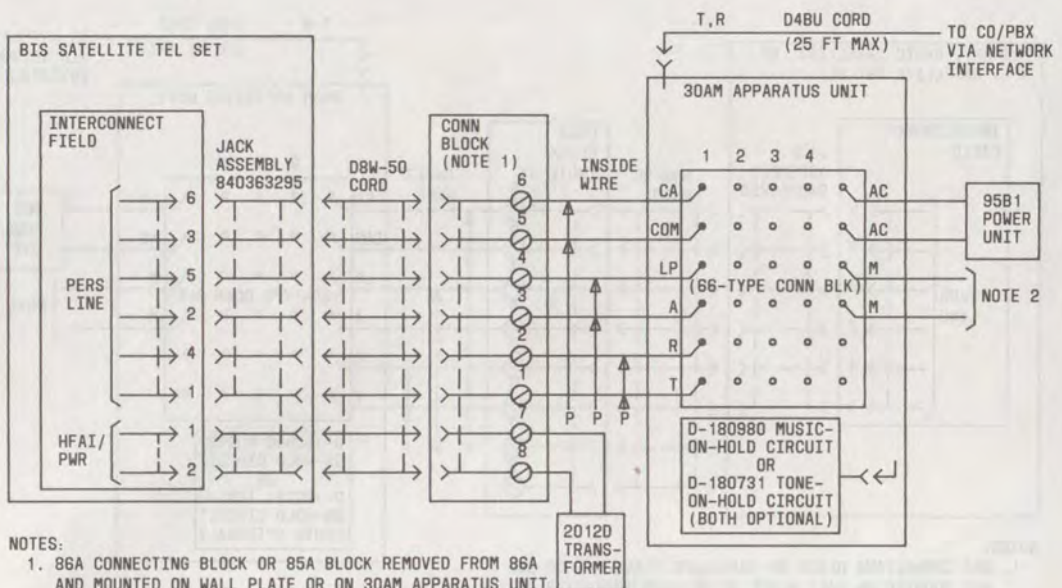

NOTES:

1. 86A CONNECTING BLOCK OR 85A BLOCK REMOVED FROM 86A AND MOUNTED ON WALL PLATE OR ON 30AM APPARATUS UNIT
2. FOR MUSIC-ON-HOLD, CONNECT TO SAME 33C VOICE COUPLER USED WITH LINES 1-4, AND INSTALL D-180980 CIRCUIT BOARD. FOR TONE-ON-HOLD, NO EXTERNAL CONNECTIONS REQUIRED; INSTALL D-180731 CIRCUIT BOARD

Fig. 40—Personal Line Connections for BIS Set Using 30AM Apparatus Unit

(2) Remove the faceplate (paragraph 5.07) and move the DSS key aside (paragraph 5.23) to gain access to the interconnect field.

(3) Remove the jack assembly from the D-180758 Kit of Parts. It consists of a group of wires terminated with a 963-type connector on one end and a modular jack on the other end. Run the leads through the cord slot behind the interconnect field. Plug the 963 connector into the PERS LINE position on the interconnect field.

(4) Replace the DSS key (paragraph 5.24) and the faceplate (paragraph 5.09).

(5) Secure the modular jack to the base by placing the bottom of the jack in the mount provided adjacent to the harness connector, and swing the top of the jack down so the snap catch locks it in place (Fig. 23).

(6) Reassemble the telephone set.

(7) Plug one end of the D8W cord (from the kit of parts) into the personal line jack on the bottom of the set (Fig. 20). Secure the cord around the strain relief bars behind the jack.

(8) Plug the other end of the D8W cord into the jack of the associated 86A block.

(b) **Desk Models of Basic Satellite and HFAl Satellite Sets (Fig. 39):**

(1) Remove the lower housing (paragraph 5.13).

(2) Turn the set over, remove the faceplate (paragraph 5.07), and move the DSS key aside (paragraph 5.23) to gain access to the interconnect field.

- (3) Install the jack assembly as described in paragraph 3.52(a)(3).
- (4) Replace the DSS key (paragraph 5.24) and the faceplate (paragraph 5.09).
- (5) Turn the set over and attach the modular jack to the chassis through the right-hand edge of the amplifier with the bracket and screw from the kit of parts (Fig. 41).

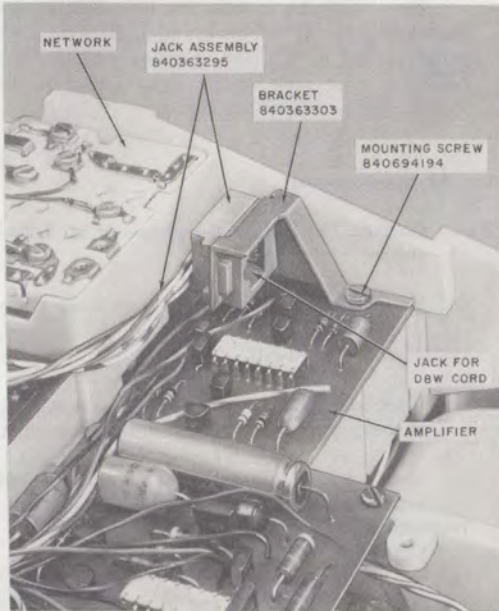

Fig. 41—Installation of Personal Line Jack Assembly

- (6) Plug one end of the D8W cord into the modular jack installed in (5).
- (7) Run the other end of the cord through the option cord opening in the lower housing (Fig. 42).
- (8) Reassemble the lower housing to the telephone set.
- (9) Secure the D8W cord around the strain relief bars.

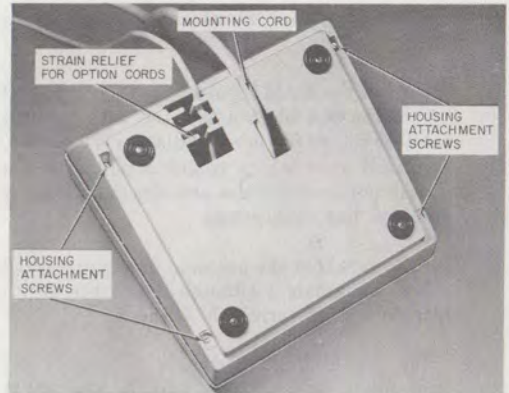

Fig. 42—Basic Satellite Desk Set, Bottom View

- (10) Plug the free end of the D8W cord into the jack of the associated 86A block.

(c) *Wall Models of Basic Satellite and HFAI Satellite Sets (Fig. 39):*

- (1) Remove the set from the wall mounting plate.
- (2) Install the jack assembly and the D8W cord as described in (b)(2) through (6).
- (3) Insert the free end of the D8W cord into the plug retainer from the kit of parts. Snap the retainer into the wall housing so that the cord plug will mate with the jack in the 85A connecting block mounted on the wall plate (Fig. 16). Fold up the excess cordage, tie with the plastic cord tie supplied with the kit, and store it inside the set behind the plug retainer.
- (4) Mount the set on the mounting plate as described in paragraph 3.24. The end of the D8W cord mounted in the plug retainer on the wall housing should plug into the modular jack of the 85A block mounted on the wall plate.

(d) **BIS Satellite Desk and Wall Sets**
(Fig. 40):

(1) After the 30AM apparatus unit is connected to the 86A block associated with the BIS satellite set, no further installation is required. The DSW cord which connects power to the speakerphone circuit also provides the necessary personal line connections.

(2) Be sure that the personal line is connected to terminals 1 through 6 and the 2012B transformer to terminals 7 and 8.

3.62 The only remaining step is to connect the incoming personal line pair to the 30AM apparatus unit; refer to FINAL SYSTEM CONNECTIONS, paragraph 3.69. After all installation is complete, test each personal line by placing and receiving a call on it at each station where it is connected. Also check for music- or tone-on-hold, if provided, when the line is placed on hold. Pick it up in the same way as any other CO/PBX line by operating the personal line button on the line key.



In existing installations, the 30A (MD) apparatus unit may be used for personal line; it is permissible to reuse this unit in other installations. Connections are shown in Fig. 43 and 44.

K. Code Busy DSS Key

3.61 Implement this feature in any 980-series telephone set by replacing the factory-installed 664B key with a 664C key as follows:

- Remove the faceplate of the telephone set (paragraph 5.07).
- Move the 664B DSS key aside (paragraph 5.23) and unplug it from the interconnect field.
- Remove the 664B key from the set.
- Plug the connector of the 664C key into the DSS KEY position on the interconnect field.
- Mount the 664C key in the telephone (paragraph 5.24).

(f) Replace the faceplate (paragraph 5.09).

(g) Set the common audible and DSS code switches as described in paragraph 3.34.



When code busy keys are used in the system, the number of stations plus the number of options assigned to the same DSS code must not exceed 4.

(h) Install E-6873 designation tabs in the new key. After all installation is complete, test each key by going off-hook and sliding the DSS programming switch from position 1 to 10. The LED for each code should light. Return the switch to its assigned position.

L. 4A Speakerphone

3.64 Connect the 4A speakerphone to an HFAI station as follows:

- If the speakerphone is to have ivory parts to match the telephone with which it is used, install a D-180508 Kit of Parts.
- Place the loudspeaker and the transmitter of the speakerphone in their desired locations.
- Mount a 223C adapter on a suitable vertical surface within cord lengths of the loudspeaker, transmitter, power unit, and telephone.
- Connect the M2FG power cord to the 85B1 power unit. **Do not plug the 85B1 into its assigned ac outlet until all installation is complete.**
- Plug the connectors of the mounting cords from the loudspeaker, the transmitter, and the 85B1 power unit into the connector of the D16H-50 cord supplied with the adapter (Fig. 45). Assemble this group of connectors in the 223C adapter and install the adapter cover.
- Remove the faceplate and upper housing of the telephone set (paragraphs 5.07 and 5.10) and move the DSS key aside (paragraph 5.23).
- Remove the three factory-installed shorting bars from the VSI/RELAY position on the interconnect field (Fig. 37). Remove the single

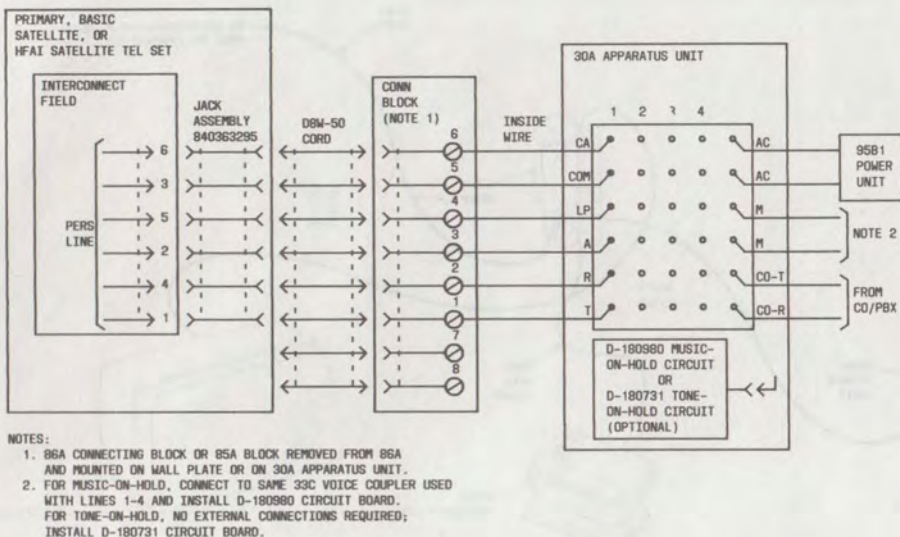

Fig. 43—Personal Line Connections for Primary, Basic Satellite, or HFAI Set Using 30A (MD) Apparatus Unit

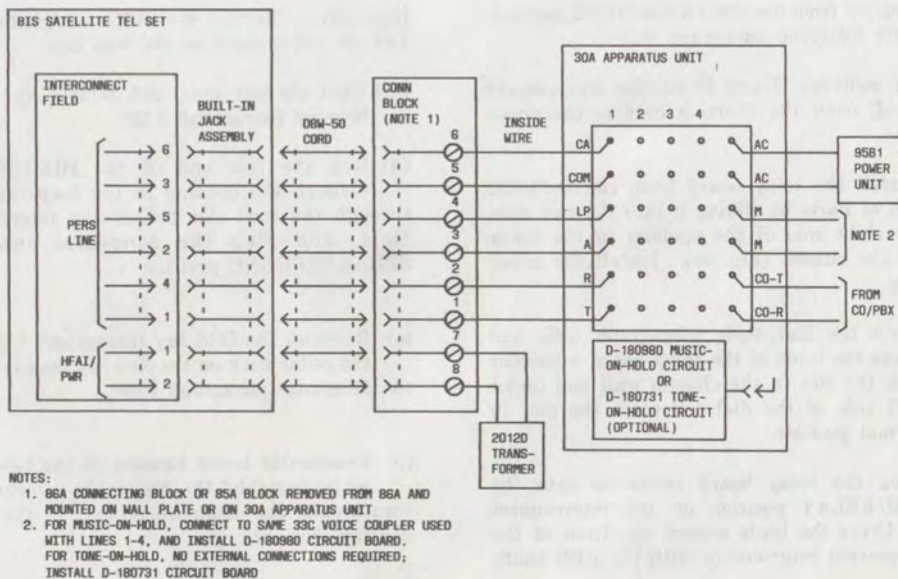

Fig. 44—Personal Line Connections for BIS Set Using 30A (MD) Apparatus Unit

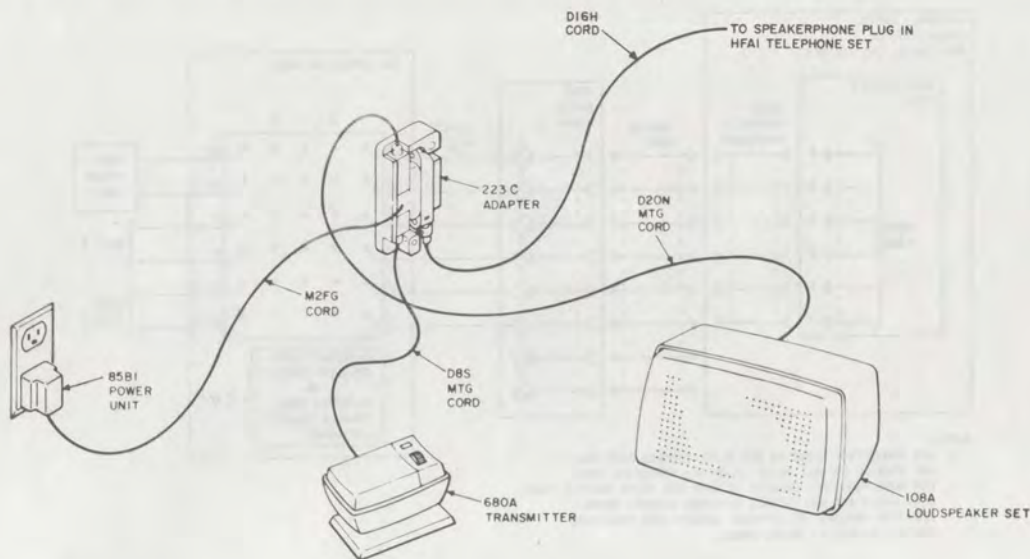

Fig. 45—4A Speakerphone Installation and Connections

shorting bar from the SPEAKERPHONE position. See note following paragraph 3.53(d).

(h) At switches G and H on the interconnect field, move the shorting bars to the upper position.

(i) Install the relay board from the D-180732 Kit of Parts by sliding it into the two slots on the right side of the opening in the lower left of the chassis (Fig. 36). Install the upper housing.

(j) Move the dial aside (paragraph 5.25) and dress the leads of the relay board connector through the slot in the chassis wall and under the left side of the dial. Replace the dial in its normal position.

(k) Plug the relay board connector into the VSI/RELAY position on the interconnect field. Dress the leads toward the front of the set to prevent interference with the ABR shaft.

(l) Remove the collar from the line key and install the U-shaped plastic button stop from the kit of parts under SPKR button to make it

inoperative. Remove the SPKR designation tab. Put the collar back on the line key.

(m) Turn the set over and remove the lower housing (paragraph 5.13).

(n) Run the free end of the D16H-50 cord through the opening in the lower housing, through the cord slot behind the interconnect field, and plug the connector into the SPEAKERPHONE position.

(o) Reinstall the DSS key (paragraph 5.24), put the collar back on the line key, and reinstall the faceplate (paragraph 5.09).

(p) Reassemble lower housing to the telephone set (paragraph 5.15). Secure the speakerphone cord around the strain relief bars in the lower housing (Fig. 42).

(q) After all installation is complete, test the speakerphone by operating it in the normal way to place and receive calls (paragraph 4.19).



If the 4A speakerphone is ever disconnected from the telephone, be sure to restore the shorting bars removed in (g) and the bars moved in (h) to their original factory position (Fig. 37); remove the button stop installed in (1) and designate the SPKR button.

M. Repertory Dialing

3.63 Connect an 870A1 or 2870A1 adjunct repertory dial to the desk-type satellite, BIS, or HFAI station where repertory dialing is desired.

- (a) Place the dial near the station.
- (b) Remove the mounting cord supplied with the dial and replace it with the D10Y-50 cord. Connect each lead of the D10Y cord to the terminal where the same color lead of the original cord was connected (Table E).

TABLE E

ADJUNCT REPERTORY DIAL MOUNTING
CORD CONNECTIONS

MOUNTING CORD LEADS	870A1 TERMINALS	2870A1 TERMINALS
W-BL	16	16
W-O	26	2
G-W	13	33
W-G	21	34
O-W	9	11
BL-W	2	17
BR-W	1	1
W-BR	8	32
S-W	3	*
W-S	6	*

* Insulated and stored.

- (c) Connect the dial power cord to the 95B1 power unit. **Do not plug the 95B1 into its assigned ac receptacle until all installation is complete.**

- (d) Remove the lower housing (paragraph 5.13).
- (e) Remove the faceplate (paragraph 5.07); move the DSS key aside (paragraph 5.23).
- (f) Remove the two factory-installed shorting bars from the REP DIAL position on the interconnect field (Fig. 37). See note following paragraph 3.53(d).
- (g) Check switches B and D on the interconnect field. Be sure that the shorting bars are in the upper position for a rotary repertory dial and in the lower position for a TOUCH-TONE repertory dial.
- (h) Run the D10Y dial cord through the openings in the lower housing, through the cord slot behind the interconnect field, and connect it to the REP DIAL position.
- (i) Reassemble the telephone. Secure the cord around the strain relief bars in the lower housing (Fig. 42). Excess cordage can be tucked into the telephone set.
- (j) After all installation is complete, test the repertory dialing feature by using it to dial CO/PBX calls.



If the repertory dial is ever removed from the station, be sure to restore the shorting bars removed in (f) and moved in (g) to their original factory positions (Fig. 37).

N. External Ringing

3.64 Up to three external ringers, such as the EICM, S1AMP, or LIAM, can be provided on any of the CO/PBX lines:



No more than three additional ringer equivalents shall be connected to the CO/PBX lines. If 24A or B apparatus units are used in the system, each must be considered as one of the ringer equivalents on their respective lines.

Using a D4BU cord (25-foot maximum) connect the external ringer to the network interface of the common or personal line where external ringing is desired. **Do not attempt to wire the ringer to any other pairs in the system.**

O. Special Handsets

3.65 Standard modular G-type handsets can be used with the desk sets when modified with the D-180851 Kit of Parts. This kit consists of ivory colored transmitter and receiver caps needed to replace the standard caps on the G-type handsets. Modified G-type handsets can be used to provide the following features when the K-type handset is incompatible:

- Impaired hearing handset
- Handset with more receive gain than G6BM (D-180413)
- Weak speech handset (G7BM)
- Noisy location handset (G8BM)
- Acoustic or inductive coupling to customer-provided equipment (G15A)
- G-type handset equipped with shoulder rest (G4BM)
- Long loop—3-dB transmit gain (G36AM).

FINAL SYSTEM CONNECTIONS

3.66 Make sure all components of the 4A System are properly mounted and interconnected and the required options are installed.

3.67 **Common CO/PBX Lines**—Connect the incoming common CO/PBX lines 1 and 2 to the 91B connecting block associated with the first primary station using a D4BU cord (25-foot maximum) between the network interface and the modular jack on the 91B (Fig. 46). Connect lines 3 and 4 to the 91B block associated with the second primary station in the same manner.

Note: If lines 3 and 4 are used, be sure that the line assignment connector on the logic board of the second primary station has been reversed as described in paragraph 3.33.

3.68 Connections for common CO/PBX lines on 91A (MD) blocks are shown in Fig. 47.

3.69 **Personal CO/PBX Lines**—Connect the incoming personal line to the 30AM apparatus unit using a D4BU cord (25-foot maximum) between the network interface and the modular jack on the 30AM (Fig. 38, 39, and 40).

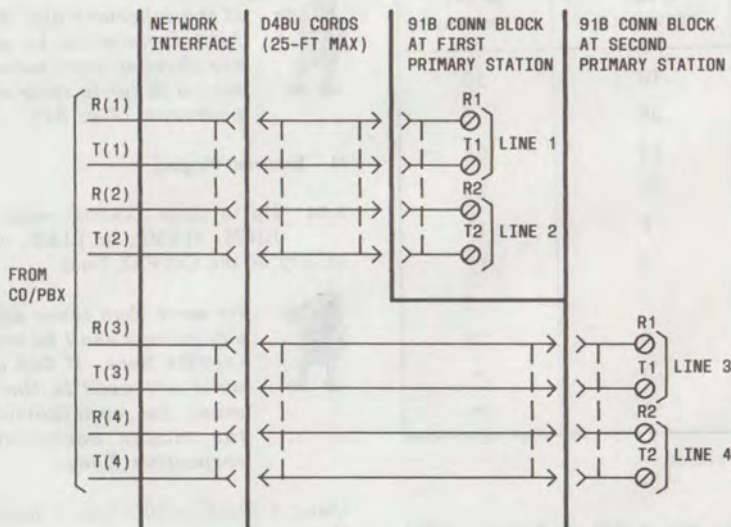

Fig. 46—CO/PBX Line Connections Using 91B Connecting Block

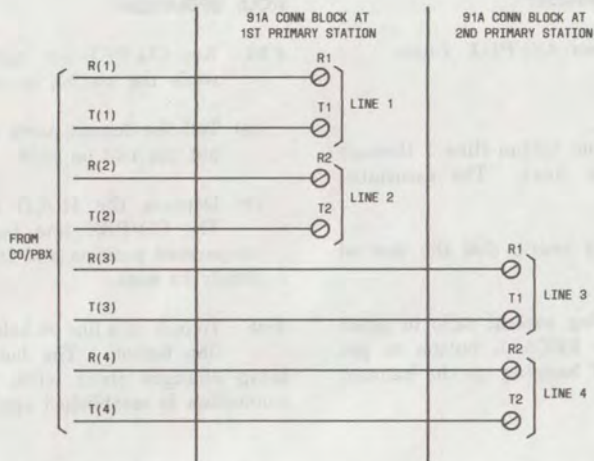

Fig. 47—CO/PBX Line Connections Using 91A (MD) Connecting Block

3.70 Connections for personal line on the 30A (MD) apparatus unit are shown in Fig. 43 and 44.

3.71 **Power Connections**—Plug the following units of the 4A System into the ac receptacles assigned to them:

- Each primary station
- The 19B4 power unit.



Remember that primary set power cords must be plugged in even when a 19B4 unit is used.

- The 85B1 power unit of each 4A speakerphone used with an HFAI station
- The 2012D transformer of each BIS station
- The 95B1 power unit of each 30AM apparatus unit
- The 95B1 power unit of each repertory dial.

3.72 Test the entire system by operating all of its features in the normal manner. If trouble develops, refer to Part 5, Maintenance.

4. METHOD OF OPERATION

ANSWERING CALLS USING HANDSET

4.01 **Incoming Call on CO/PBX Line**—When a tone signal sounds and a CO/PBX line button lamp flashes, answer the call as follows:

- (a) Lift the handset.
- (b) Depress the line button where the lamp is flashing. The tone ringing is silenced and the lamp goes steady.
- (c) Talk with the calling party. [While the call is in progress, the level of incoming voice and tone signaling from the loudspeaker is reduced unless the built-in loudspeaker service is being used (paragraph 4.29).]

4.02 **Intercom Call**—When an intercom voice signal is heard and an intercom path button lamp lights, answer the call as follows:

- (a) Listen for instructions from the calling party.
- (b) If a two-way conversation is to be conducted, lift the handset and depress the proper intercom path button to establish the talking path.

PLACING CALLS USING HANDSET

4.03 *Outgoing Call on CO/PBX Line:*

- (a) Lift the handset.
- (b) Depress an idle line button (line 1 through 4 or the personal line). The associated lamp lights steady.
- (c) When dial tone is heard, dial the desired number.

Note: When making several calls in quick succession, use the RECALL button to get dial tone instead of hanging up the handset after each call.

4.04 *Intercom Call:*

- (a) Lift the handset.
- (b) Depress an idle intercom path button (1 or 2). The associated lamp lights at all stations. (There is no dial tone on intercom.)



On outgoing intercom calls from stations equipped with the standard DSS key, the calling party has no way of knowing beforehand if the code being called is busy. At stations having a code busy DSS key, the code of any station which is off-hook or being voice signaled is identified by a steady light in the DSS button.

- (c) To voice signal the called station, depress and hold the DSS button corresponding to the code of the called station. Transmit the one-way message to the called station. Release the DSS button when the message is completed.
- (d) When the called party answers [as described in paragraph 4.02(b)], a two-way conversation path is established and the DSS button need not be depressed again.

Note: Multiple stations can be signaled by operating more than one DSS button at a time or by using the preset multiple voice-signaling option (see paragraph 4.31).

HOLD OPERATION

4.05 Any CO/PBX line call can be put on hold while the station is used for another call:

- (a) Tell the distant party that you are going to put the call on hold.
- (b) Depress the HOLD button momentarily. The CO/PBX line button restores to its unoperated position and its lamp changes from steady to wink.

4.06 To pick up a line on hold, depress the winking line button. The button locks down, the lamp changes from wink to steady, and the connection is established again.

ANSWERING CALLS USING BUILT-IN SPEAKERPHONE

Note: On BIS satellite sets, incoming tone ringing and intercom voice signaling are transmitted over the loudspeaker mounted under the handset. Two-way speakerphone conversations utilize the loudspeaker in the speakerphone module on the right side of the set.

4.07 *Incoming Call on CO/PBX Line*—When a tone signal sounds and a CO/PBX line button lamp flashes, answer the call as follows:

- (a) Depress the line button where the lamp is flashing. The tone ringing is silenced, the lamp goes steady, and the speakerphone turns on automatically. The red speakerphone lamp lights.
- (b) Face the set and carry on the conversation in a normal voice. The volume of the incoming call can be adjusted with the control on the speakerphone module.
- (c) When the conversation is finished, depress the speakerphone OFF button.

Note: Whenever the speakerphone OFF button is operated, all depressed CO/PBX line or intercom path buttons will restore.

4.08 Intercom Call—When an intercom voice signal is heard and an intercom path button lamp lights, answer the call as follows:

- (a) Listen for instructions from the calling party.
- (b) If a two-way conversation is to be conducted, depress the proper intercom path button to turn on the speakerphone and establish a talking path.
- (c) When the conversation is finished, depress the speakerphone OFF button.

PLACING CALLS USING BUILT-IN SPEAKERPHONE

4.09 *Outgoing Call on CO/PBX Line:*

- (a) Depress an idle line button (line 1 through 4 or the personal line). The lamp next to the button lights and dial tone is heard on the speakerphone loudspeaker.
- (b) Dial the desired number.
- (c) When the call is finished, depress the speakerphone OFF button.

4.10 *Intercom Call:*

- (a) Depress an idle intercom path button. The lamp next to the button lights and the speakerphone turns on. The red speakerphone lamp lights. No dial tone is heard.
- (b) To voice signal the called station, depress and hold the appropriate DSS button, face the set, and transmit the one-way message via the speakerphone microphone. Speak in a normal voice. Release the DSS button when the message is completed.
- (c) When the called party answers, a two-way conversation path is established. Carry on the conversation using the built-in speakerphone.
- (d) When the call is finished, depress the speakerphone OFF button. Depressed intercom button will restore.

Built-In Speakerphone Operating Features

4.11 Mike Off—To interrupt transmission to the distant party during a speakerphone

call, depress and hold down the MIKE OFF button. Incoming conversation from the distant party is not affected.

4.12 Transferring From Speakerphone to Handset—Simply pick up the handset and continue the call in the normal way. The speakerphone turns off automatically.

4.13 Transferring From Handset to Speakerphone—Hold down the line button(s) and hang up the handset. The line button(s) remains operated and the speakerphone is turned on. Continue the call using the built-in speakerphone.

ANSWERING INTERCOM CALLS AT HFAI STATION

Note: The HFAI feature is used only for answering intercom calls originated at other stations. To place an intercom call from an HFAI station, use the standard procedure described in paragraph 4.04 or the 4A speakerphone (paragraph 4.21) if one is connected.

4.14 Incoming intercom calls at an HFAI station turn on the transmitting microphone in the HFAI module so that the calls can be answered without any manual action. The calling party controls the microphone, turning it on when the DSS button is released following a voice announcement, and turning it off when the DSS button is depressed. The operation of the HFAI feature is as follows:

- (a) An incoming call is preceded by a medium pitch (625-Hz) tone burst over the set's built-in speaker. One of the two green lamps on the HFAI module stays on throughout the call, indicating which intercom path is being used; the red lamp turns on when the caller releases the DSS button, indicating that the microphone is on.
- (b) While the red lamp is on, face the set and answer the call in a normal voice.
- (c) Continue the conversation with the distant party, speaking only when the red lamp is on.
- (d) No action is required at the HFAI station when the call ends. When the caller hangs up, the mike and IC lamps go out and the HFAI module turns off.

HFAI Operating Features

4.15 Mike Off—To interrupt transmission to the distant party during an HFAI call, depress the locking MIKE OFF button on the HFAI module. Incoming conversation from the caller is not affected. To release the MIKE OFF button, depress it again. While the MIKE OFF button is depressed, the microphone is totally disabled and cannot be turned on by the distant party.

4.16 Do-Not-Disturb—If reception of incoming intercom calls at the HFAI station is not desired, depress the locking DO NOT DSTRB button. This causes a low pitch (156-Hz) tone to be transmitted to any caller who has called the station by operating a DSS button; it also disables the amplifier in the local set, preventing reception of intercom voice signals. To return to the normal HFAI mode, repress the DO NOT DSTRB button, unlocking it.

4.17 Transferring From HFAI Mode to Handset—Tell the caller that transfer from the HFAI mode to handset is taking place and that operation of the DSS button is no longer required. Depress the proper IC button on the line key, pick up the handset, and continue the call in the normal manner.

CALLING AN HFAI STATION

4.18 To place an intercom call to an HFAI station:

- (a) Lift the handset.
- (b) Depress an idle intercom path button. The associated lamp lights at all stations.
- (c) Depress and hold the DSS button corresponding to the code of the HFAI station.
- (d) If the HFAI station is not busy and not in the "do-not-disturb" mode, a medium pitch tone burst is heard when the DSS button is depressed to voice signal the station. Make the announcement to the HFAI station after the tone. Release the DSS button to hear the HFAI station's response.

Note: After the HFAI station has answered, operation of the DSS button to talk again does not result in any more tones.

(e) If the HFAI station is in the "do-not-disturb" mode, a continuous low pitch tone is heard when the DSS button is depressed. The call cannot be completed. Hang up and call again later.

(f) If the HFAI station is busy with another call, no return signal is heard. Hang up and call again later.

4A SPEAKERPHONE OPERATION

4.19 The 4A speakerphone can be installed only with an HFAI station telephone set. It is used to provide optional hands-free operation on CO/PBX line calls or outgoing intercom calls.

4.20 Incoming Calls—When a tone signal sounds and a CO/PBX line button lamp flashes, answer the call as follows:

- (a) Depress the line button where the lamp is flashing.
- (b) Operate the ON button of the speakerphone transmitter. The tone ringing will be silenced and the lamp will go steady.
- (c) Talk with the calling party using the transmitter and the loudspeaker.
- (d) When the conversation is over, operate the OFF switch on the speakerphone transmitter.

Note: Operation of the speakerphone OFF switch does not cause line buttons to pop up. To restore line buttons, lift the handset momentarily. Always do this after a conference call.

4.21 Outgoing Calls:

- (a) Depress an idle line or intercom button.
- (b) Operate the ON button of the speakerphone transmitter. Dial tone is heard on CO/PBX lines but not on intercom.
- (c) Dial the desired CO/PBX number or voice signal the desired station.
- (d) When the called party answers, use the transmitter and the loudspeaker to carry on the conversation.

- (e) When the conversation is over, operate the OFF button on the speakerphone transmitter. [See Note following paragraph 4.20(d).]

4.22 When it is not desired to transmit conversation from the surrounding area to the distant station, disable the transmitter by holding down the ON button. Incoming conversation will not be affected.

4.23 To transfer from speakerphone to handset operation during a conversation, simply lift the handset. Transfer occurs automatically.

4.24 To transfer from handset to speakerphone operation during a CO/PBX line conversation:

- (a) Put the line on hold
- (b) Hang up the handset
- (c) Turn the speakerphone on
- (d) Depress the CO/PBX line button.

4.25 To transfer from handset to speakerphone operation during an intercom call:

- (a) Hang up the handset
- (b) Turn the speakerphone on
- (c) Depress the IC button.

MISCELLANEOUS OPERATING TECHNIQUES

4.26 Multiline Conferencing—Two or more CO/PBX lines and any 4A System station can be conferenced by placing several successive calls on hold and then picking them up together as follows:

- (a) Establish a CO/PBX line connection either by answering an incoming call or completing an outgoing call.
- (b) Put the call on hold by depressing the HOLD button; the line button will restore to its unoperated position and its lamp will wink.
- (c) Establish another CO/PBX line call.
- (d) While holding down the second line button, depress the held line button. The local

station and the two CO/PBX lines are then conferenced together.

- (e) Additional CO/PBX lines may be added by repeating (b), (c), and (d).

Note: The number of lines which can be conferenced satisfactorily is limited because transmission quality among the lines will be degraded as more lines are added.

- (f) To put all the outside lines on hold simultaneously, depress the HOLD button; to reenter the conference, simultaneously depress the line buttons again.



Intercom and CO/PBX lines cannot be conferenced together.

4.27 Multistation Conferencing—To add other stations in the system to a CO/PBX line call, follow this procedure:

- (a) Place the CO/PBX line call on hold.
- (b) Using the intercom, call the station or stations wanted in the conference and tell each to pick up the line on hold.
- (c) Return to the held line by picking it up at the local station again. The conference is established when the other stations pick up the held line also.
- (d) If any of the stations to be conferenced has the **privacy** feature, all the stations should hold down their PRIV RLS buttons until everyone has picked up the held line.
- (e) Any station can hang up during the conference without affecting the other parties.

4.28 Repertory Dialing—At stations where a repertory dialing adjunct is attached, outside dialing can be done either on the telephone set dial, the dial on the adjunct, or by means of the memory buttons on the adjunct. Refer to Section 501-164-202 for detailed information on the operation of the repertory dialer.

4.29 Built-In Loudspeaker Service (Stations Without Speakerphone)—To amplify and

broadcast to the surrounding area the incoming part of a telephone conversation, depress the SPKR button on the line key. The button locks down until depressed again. Adjust the output to the desired level with the thumbwheel volume control. When the conversation is over, release the SPKR button before replacing the handset so that feedback "squeal" does not occur when the handset is brought near the speaker.



Incoming voice and tone signaling is not attenuated in the off-hook condition if the SPKR button is locked down. This button is not linked to the ABR mechanism.

4.30 Paging—The paging system is used in the same way as voice signaling on intercom. To make an announcement, go off-hook, select an idle intercom path, depress the DSS button of the paging code. Transmit the message over the handset while holding down the DSS paging button.

4.31 Preset Multiple Voice Signaling on Intercom—This feature is used in the same way as voice signaling a single station. Go off-hook, select an idle intercom path, then depress the DSS button corresponding to the preset group of stations to be signaled. Transmit the message over the handset while holding down the DSS code button.

4.32 Supplementary Signaling—To operate an auxiliary signal via a 25A apparatus unit, momentarily depress the DSS button assigned to supplementary signaling. Repeat the operation as required.

5. MAINTENANCE

5.01 Maintenance of the 4A System is limited to wiring checks, replacement of entire telephone sets or components specified as replaceable (see ORDERING GUIDE), and replacement of external apparatus. Do not attempt to modify or repair telephone sets or apparatus units in any way not covered in this practice.

5.02 When trouble develops, first make a thorough check of all interconnecting cable connectors. Check for the following conditions before considering the replacement of any components:

- Primary station power cords connected to working ac receptacles

- Primary station power transformers securely in place
- Set mounting cords securely connected at both ends
- All component connectors securely seated on the interconnect field
- Shorting bars in their proper positions on the interconnect field
- Wall sets mounted so that the connectors on the wall plate mate properly with the connectors on the back of the set
- Loudspeaker volume control set to normal level
- Incoming CO/PBX pairs from building entrance facility securely terminated on network interface blocks
- Tip and ring pairs from network interface blocks to 91B connecting blocks and 30AM apparatus units properly connected
- Correct wiring on apparatus units and adjuncts.

DIAGNOSTIC PROCEDURES

5.03 If normal service is provided on at least one primary set and possibly some satellite sets, the problem is likely to be in the cabling. If all sets beyond a point in the cable bus relative to a primary set exhibit the same trouble, the cable fault is probably an open conductor path.

5.04 If all sets exhibit the same trouble, the following sequence should be tried. Disconnect all satellite sets from the system cabling; leave each primary set connected to its assigned 91B connecting block. The primary set(s) should be operating properly; if they do not, check the tip and ring coming into the 91B block for dial tone. Replace the primary set if necessary. Once it is functioning correctly, reconnect the system cable to the 91B block. If the primary set now fails to work, the problem is a short or a reversed wire in the cable. If the primary set works properly, start adding satellite sets, one at a time, until the problem reappears. Replace the last added set and reconnect the remaining sets.

5.05 Table F contains information for diagnosing and correcting troubles in a 4A System installation. Block diagrams of the 981/2981- and 983/2983-type telephone sets are shown in Fig. 48 through 52.

DISASSEMBLY AND ASSEMBLY OF TELEPHONE SETS

5.06 The installation of some of the options available with the 4A System and the replacement of some internal parts require that the telephone set housing and related components be disassembled and reassembled. See paragraphs 5.07 through 5.20 for instructions on procedures which are common to several installation or replacement operations.

A. Faceplate

5.07 To remove the faceplate from any telephone set:

- (a) Insert the blade of a small screwdriver between the center of upper edge of the faceplate and the adjacent housing (Fig. 53).
- (b) Carefully tip the handle of the screwdriver back away from the telephone set, disengaging the tab on the center of the upper edge of the faceplate from the housing.
- (c) Lift the faceplate away from the set.

5.08 With the faceplate off, the following components are accessible:

- Dial
- DSS key
- Upper housing.

5.09 To install the faceplate:

- (a) Insert the tabs on the lower edge under the lip of the housing.
- (b) Using the thumb and forefinger of each hand, bow the center of the faceplate up slightly (Fig. 54). Position the tab on the upper edge under the lip of the housing and release the faceplate.

(c) Be sure that all tabs are engaged and that the faceplate fits securely around all components.

B. Upper Housing

5.10 The upper housing is secured to the telephone set chassis by four screws in the primary and basic satellite sets (Fig. 55) and five screws in BIS and HFAI sets. The screw on the left side under the handset also serves to hold the housing blank or handset hook, depending on whether the set is desk or wall mounted. The other screws are captive in the housing. To take off the housing:

- (a) Remove the faceplate (paragraph 5.07)
- (b) Remove the number card retainer and the number card
- (c) Remove the housing blank (desk sets) or handset hook (wall sets) and the screw which holds it
- (d) Loosen the captive screws
- (e) Lift the housing off the set.

5.11 With the upper housing off (Fig. 5), the following components are accessible:

- Loudspeaker assembly
- Slots for mounting privacy board and relay board, and/or voice signaling interface board (Fig. 36)
- Handset cord jack
- Recall key
- Loudspeaker volume control
- Line key
- BIS module
- HFAI module.

5.12 To replace the upper housing, reverse the disassembly procedure of paragraph 5.10. Tighten the screws. Replace the number card and its retainer.

TABLE F
DIAGNOSTIC ROUTINES

TROUBLE	POSSIBLE CAUSES	POSSIBLE SOLUTIONS
<p><i>Note:</i> Before taking the specific steps recommended below, perform the general maintenance checks listed in paragraphs 5.02, 5.03, and 5.04.</p>		
TIP-RING		
Dialing not possible.	Set wired for dial restriction option.	Check positions of switches E and F (paragraph 3.55). If option is not desired, rewire.
No sidetone on CO/PBX line.	Incoming CO/PBX line dead.	Check incoming tip and ring with test set.
	Incoming tip and ring terminated on wrong terminals.	Check connections (Fig. 46).
	Switch pile-up on telephone defective.	Change out telephone set.
	Privacy circuit (if set is so equipped) operating incorrectly.	Replace privacy circuit (paragraph 3.53).
	Set has privacy circuit and CO/PBX line is in use by another station.	No corrective action necessary; wait until line is not in use.
	If set is supposed to have dial restriction, switches E and F on interconnect field may not be in proper positions.	Check positions of switches E and F (paragraph 3.55).
	If 66-type connecting blocks are used, cutdown may be incorrect.	Check station cutdown.
System wired for 3 or 4 CO/PBX lines, but dial tone only on lines 1 and 2.	Line assignment connector not rotated on second primary set.	Rotate line assignment connector on second primary set (paragraph 3.33).
VOICE SIGNALING		
One set does not receive voice signaling on DSS.	Station designation not coded properly on DSS key.	Check for correct position of slide switch (paragraph 3.34). Be sure switch is properly engaged in detent (centered on number).
Low volume on tone ringing or voice signaling.	Volume control set too low.	Readjust volume.
	Handset off-hook.	Replace handset.

TABLE F (Contd)
DIAGNOSTIC ROUTINES

TROUBLE	POSSIBLE CAUSES	POSSIBLE SOLUTIONS
VOICE SIGNALING (Contd)		
DSS signaling to other sets possible, but DSS signaling from other sets not possible, and SPKR button does not work.	Amplifier or speaker defective.	Replace amplifier and/or speaker (paragraphs 5.27 and 5.42).
DSS signaling from other sets possible, but DSS signaling to other sets not possible, and SPKR button does not work.	Amplifier defective.	Replace amplifier (paragraph 5.42).
Noisy intercom system.	Earth ground connected to system cable at some point.	Be sure that G terminal on 19B4 power unit is not grounded. Check all terminal blocks for improper grounds.
Excessive noise heard from set loudspeaker during intercom voice signaling.	Unauthorized connection between system (particularly 19B4 power unit) and building ground.	Check wiring of system for connections to building ground and remove all except for 117 volts power cords and 33C voice coupler.
Noise from speaker as volume control is rotated.	Defective volume control.	Replace volume control (paragraph 5.33).
COMMON AUDIBLE TONE SIGNALING		
One set does not ring on some line(s), but lamp flashes properly.	Common audible switches not set properly.	Set the four common audible switches for the desired ringing at that station (paragraph 3.34).
HOLD		
One line goes on hold when going off-hook.	"A" lead open between malfunctioning set(s) and primary set controlling that line.	Check cable connections.
False hold condition when changing lines or lightly touching line buttons.	Defective line key.	Replace line key (paragraph 5.35).
Excessive crosstalk on lines 1 and 2 or 3 and 4 when on hold.	Improper installation of music-on-hold option.	Check wiring of 33C coupler. Remove music-on-hold board if option is not being used.

TABLE F (Contd)
DIAGNOSTIC ROUTINES

TROUBLE	POSSIBLE CAUSES	POSSIBLE SOLUTIONS
MUSIC-ON-HOLD		
No music-on-hold.	Blown fuse on 33C voice coupler.	Replace fuse.
	Improper wiring of music-on-hold option.	Check connection between coupler and 91B connecting block (Fig. 23).
Music distorted or too low.	Improper adjustment of music level.	Readjust music level (paragraph 3.40).
	Customer's music source does not have sufficient output.	Request that customer upgrade music source.
Music-on-hold source crosstalks into intercom lines.	System installed without a 91B connecting block at each primary set.	Install and connect a 91B connecting block at each primary station (Fig. 8 and 9).
POWER		
As system activity increases, all functions except sidetone on CO/PBX lines fail. Power transformers unusually warm. System restores within 30 minutes.	System is overloaded; thermal cutout is operating. Equivalent station count is exceeded.	Add supplementary power to system.
Lamps dim, voice signaling distorted, and code-busy DSS key does not work.	System is overloaded with sets and/or options.	Review requirements for system wiring and supplementary power (paragraph 3.13).
19B4 power unit blows fuses as system activity increases.	Excessive optional features.	Remove some features. Station equivalent number must be less than 32 (paragraph 3.14).
19B4 power unit blows fuses when plugged in.	Reversed polarity on system supply bus.	Correct polarity to system cable at cut down.
Transformer unusually warm, excessive noise heard from set loudspeaker during intercom voice signaling.	Power supply was shorted long enough to permit thermal cutout in transformer to operate.	<ol style="list-style-type: none"> 1. Replace transformer (paragraph 3.33). 2. Replace primary set. 3. Wait up to 30 minutes for thermal circuit breaker to reset automatically.

TABLE F (Contd)

DIAGNOSTIC ROUTINES

TROUBLE	POSSIBLE CAUSES	POSSIBLE SOLUTIONS
POWER (Contd)		
Lines go on hold when going off-hook; voice signaling does not work; no ringing on any line.	SYS/SUPP plug connected for supplementary power when this is not provided.	Put SYS/SUPP plug in proper position (paragraph 3.36).
	If system has supplementary power: It may not be connected to ac.	Connect 19B4 power unit to live ac outlet.
	Fuse blown.	Correct condition that caused blown fuse and replace fuse.
Sidetone on CO/PBX lines, but no lamps on CO/PBX or intercom lines, no ringing, no intercom talk battery.	No power applied to associated primary set.	Verify power at ac outlet and sets plugged in.
CODE BUSY		
DSS busy lamps stay on when station is idle or will not go on when station is busy.	Excessive voltage drop on +V bus. System loaded at or near capacity with long cable runs and/or too many stations bridged at ends of long runs.	<ol style="list-style-type: none"> 1. If 91B connecting blocks are not used with primary sets, install them. 2. Calculate equivalent set count (paragraph 3.14). Install supplementary supply and home run system if necessary. 3. Rearrange layout of wiring to reduce long runs. Reduce bridging at ends of runs.
	Number of stations plus number of options assigned to same DSS code exceeds 4.	Reduce number to 4.
LAMPS		
One lamp does not light at one station, but lights at other stations.	Lamp failure.	Replace line key (paragraph 5.35).
A particular lamp does not light at any station, and there is an audible buzz on the line associated with the lamp.	Lamp pair shorted or transposed on a connecting block.	Correct wiring.
All CO/PBX lamps light dim; noise on intercom on all sets.	System power supply shorted.	Disconnect sets one at a time. If problem persists, check cable.

TABLE F (Contd)
DIAGNOSTIC ROUTINES

TROUBLE	POSSIBLE CAUSES	POSSIBLE SOLUTIONS
PRIVACY		
Privacy circuit does not prevent pickup when going off-hook on a busy line.	Defective privacy circuit.	Replace privacy circuit (paragraph 3.53).
Privacy circuit does not prevent pickup on busy line when rapidly changing lines, but is okay going off-hook.	Defective line key.	Replace line key (paragraph 5.35).
HANDS-FREE ANSWER		
In system with two intercom paths, HFAI station seizes only path 1 on hands-free answering.	Shorting bar not removed from HFAI module.	Remove shorting bar from module (paragraph 3.31).
In system with only intercom path 1 active, HFAI station latches up on intercom path 2 when called on path 2.	Shorting bar missing from HFAI module.	Install shorting bar in module (paragraph 3.31).
In system with only intercom path 2 active, HFAI station will not seize path 2 when called but will latch up on path 1 when called.	Primary set coded to serve CO/PBX lines 3 and 4 and intercom path 2.	Code primary set to serve CO/PBX lines 1 and 2 and intercom path 2 (paragraph 3.33).
PERSONAL LINE		
Talking and dialing possible on personal line, but no hold, lamp, or ringing.	95B1 power unit used with 30AM apparatus unit disconnected from ac outlet or from 30AM unit.	Check connection and wiring (Fig. 39 through 42).
	95B1 inoperative.	Replace 95B1 power unit.
	No power at ac outlet.	Plug 95B1 into live outlet.
Personal line goes on hold when going off-hook.	System "A" lead open.	Check wiring for open in "A" lead between set and 30AM apparatus unit (Fig. 39 through 42). Correct if necessary.
	No system +V.	Check power wiring and connections.
Personal line on all sets except BIS sets.	System tip and ring reversed.	Reverse tip and ring at output of 30AM apparatus unit.

TABLE F (Contd)

DIAGNOSTIC ROUTINES

TROUBLE	POSSIBLE CAUSES	POSSIBLE SOLUTIONS
REPERTORY DIALING		
Set goes on hold after hanging up while the TOUCH-TONE repertory dial is dialing. or Rotary pulses heard in hand-set while the rotary repertory dial is dialing.	Switches B and D on interconnect field not in proper positions.	Correct positions of shorting bars at switches B and D (paragraph 3.63).

C. Lower Housing (All Satellite Desk Sets)

5.13 The lower housing is secured to the telephone set chassis by four captive screws in the basic satellite desk set (Fig. 42) and by six screws in the BIS and HFAI desk sets. To remove the housing:

- (a) Turn the set over and remove any option cords from the strain relief bars
- (b) Loosen the attachment screws
- (c) Pull the housing away from the set.

5.14 With the lower housing off (Fig. 56), the following components are accessible:

- Amplifier (on the chassis)
- Interconnect field (on the chassis)
- Mounting cord (on the lower housing).

5.15 To install the lower housing, reverse the disassembly procedure of paragraph 5.13. Tighten the screws.

D. Wall Housing (All Satellite Wall Sets)

5.16 In place of the lower housing on the desk set, the wall set has a housing which adapts it to the wall mounting plate. Remove the wall housing as follows:

- (a) If the set is on a wall plate, loosen the two locking screws at the bottom of the

plate (Fig. 16). Swing the telephone up (detaching the line key from the mounting cord) and lift to unhook it from the top of the plate.

(b) Place the set face down and detach the housing by loosening the four captive screws which hold it to the chassis.

5.17 With the wall housing off, the following components on the chassis are accessible.

- Amplifier
- Interconnect field.

5.18 To install the wall housing:

(a) Put the housing back on the chassis and tighten the four screws.

(b) Attach the wall set to the wall plate by tilting the set back about 30 degrees and engaging the hooks at the top of the plate in the slots in the upper corners of the set housing (Fig. 18). Swing the set down so the line key plug engages the connector mounted on the wall plate. While pressing the set firmly against the plate, tighten the two locking screws at the bottom of the plate (Fig. 16).

E. Lower Housing (Primary Sets)

5.19 The additional control logic and power circuitry contained in the primary set is mounted on the base and logic assembly (Fig. 6). Above this assembly and held in place between it and the upper housing is the lower housing which

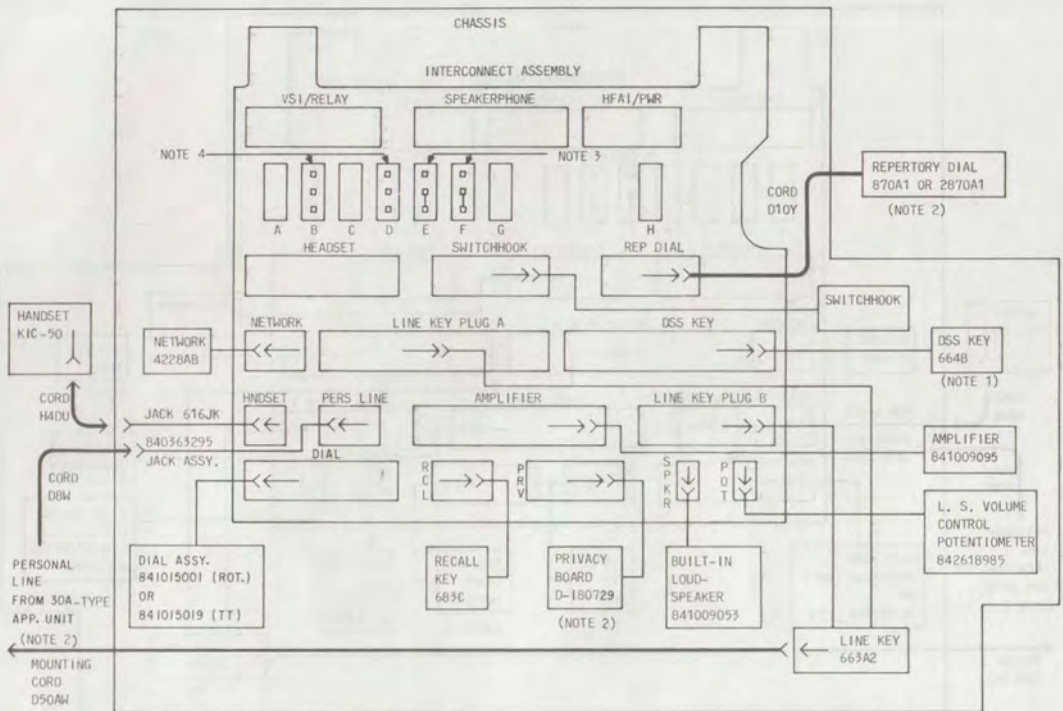

NOTES:

1. CAN BE REPLACED WITH CODE BUSY DSS KEY 664C.
2. OPTIONAL FEATURE.
3. SHORTING BARS FACTORY-INSTALLED FOR UNRESTRICTED STATION DIALING.
4. SHORTING BARS FACTORY-INSTALLED IN UPPER POSITION FOR ROTARY SET AND IN LOWER POSITION FOR TOUCHTONE SET.

Fig. 49—Block Diagram of Basic Satellite Desk Set

encloses the sides, front, and back of the set. To remove this lower housing:

- (a) Disconnect the handset cord from its jack.

Turn the set over and loosen the four captive chassis attachment screws (Fig. 20). If the set is equipped with a personal line, disconnect the D8W cord from its jack.

- (b) While holding the base and chassis assembly together with both hands, turn the set back over to its normal position. Lift the chassis assembly off the base and place upside down on the desk adjacent to the left side of the base (Fig. 6).

- (c) If the set is equipped with a personal line jack assembly, remove the jack from the base by pushing the retaining latch toward the front of the base and pulling up the jack.

- (d) Lift the lower housing off the base.

- 5.20 To install the lower housing and reassemble the set, reverse the procedure of paragraph 5.19.

REMOVAL AND INSTALLATION OF COMPONENTS

- 5.21 All replaceable components of the 980-series telephone sets have leads terminated in

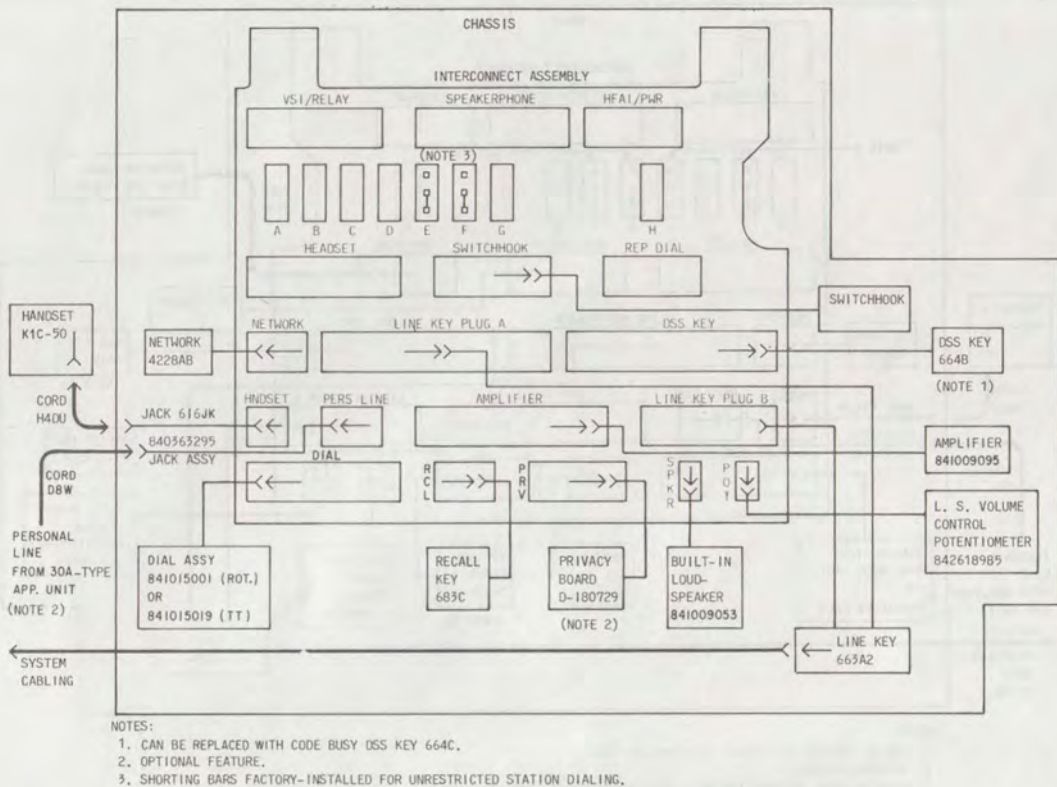

Fig. 50—Block Diagram of Basic Satellite Wall Set

963-type connectors for plugging into the interconnect field. To disconnect one of the components from the interconnect field, grasp all the wires just above the connector at the cord tie (Fig. 57) and pull straight out. (It is difficult to grasp the jack itself; the wires are attached to it in such a way that pulling on them to disconnect is not damaging, provided all the wires are pulled together.)

5.22 To plug a component into the interconnect field, first determine the correct orientation of the connector with respect to the proper interconnect field slot; they are keyed to fit together only one way. Grasp the wires just above the jack and push the jack firmly into the interconnect field.



In order to gain access to the interconnect field, it is always necessary to move the DSS key out of the way as described in paragraph 5.23, but not necessary to unplug it.

A. DSS Key

5.23 To remove the key:

- (a) Remove the faceplate (paragraph 5.07)
- (b) Push the metal latch on the left side of the key (Fig. 55) to the right to release the key
- (c) Swing the left side of the key up and disengage the right side from the chassis

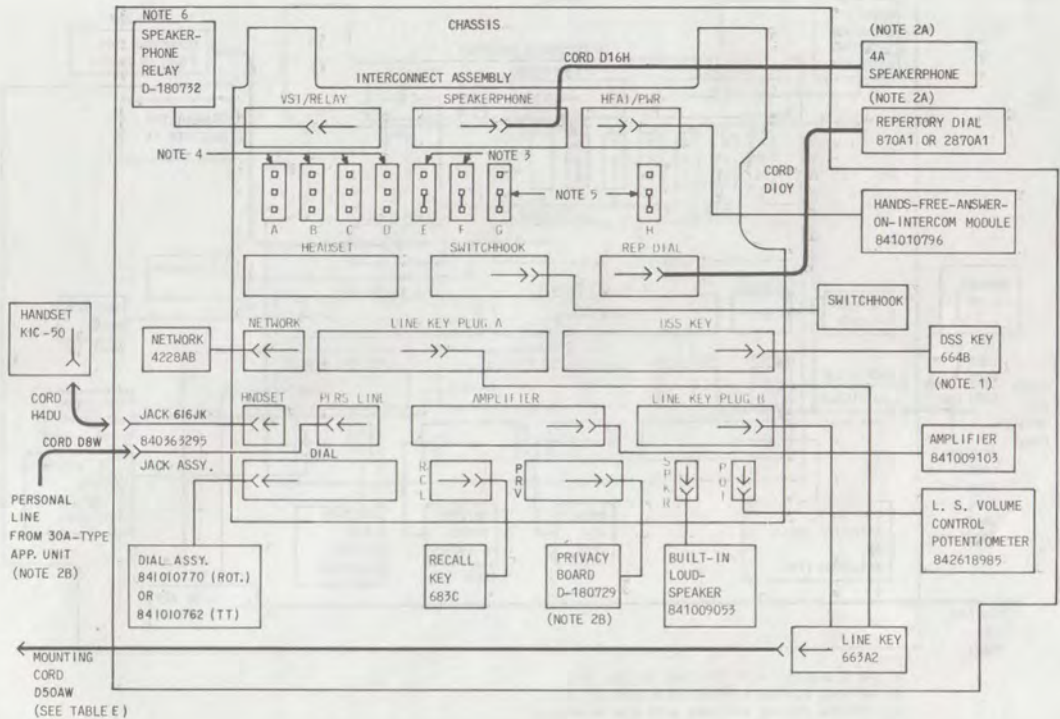

NOTES:

1. CAN BE REPLACED WITH CODE BUSY DSS KEY 664C.
- 2A. OPTIONAL FEATURE AVAILABLE WITH DESK SET ONLY.
- 2B. OPTIONAL FEATURE AVAILABLE WITH DESK OR WALL SET.
3. SHORTING BARS FACTORY-INSTALLED FOR UNRESTRICTED STATION DIALING.
4. SHORTING BARS FACTORY-INSTALLED IN UPPER POSITION FOR ROTARY SET AND IN LOWER POSITION FOR TOUCHTONE SET.
5. SHORTING BARS FACTORY-INSTALLED FOR SET WITHOUT 4A SPEAKERPHONE.
6. REQUIRED ONLY WHEN 4A SPEAKERPHONE IS CONNECTED.

Fig. 52—Block Diagram of HFAI Satellite Set

- (b) Push the plastic latch on the left side of the dial (Fig. 5) to the left to release the dial
- (c) Swing the left side of the dial up and disengage the right side from the chassis
- (d) Move the DSS key aside to get access to the interconnect field (paragraph 5.23)
- (e) Lift the dial up from the chassis and unplug its connector from the interconnect field.

5.26 To install the dial:

- (a) Plug the dial connector into the DIAL position of the interconnect field.
- (b) Engage the right side of the dial bracket in the right side of the opening in the chassis. **Make sure the leads from other components are not caught between the dial bracket and the chassis.**

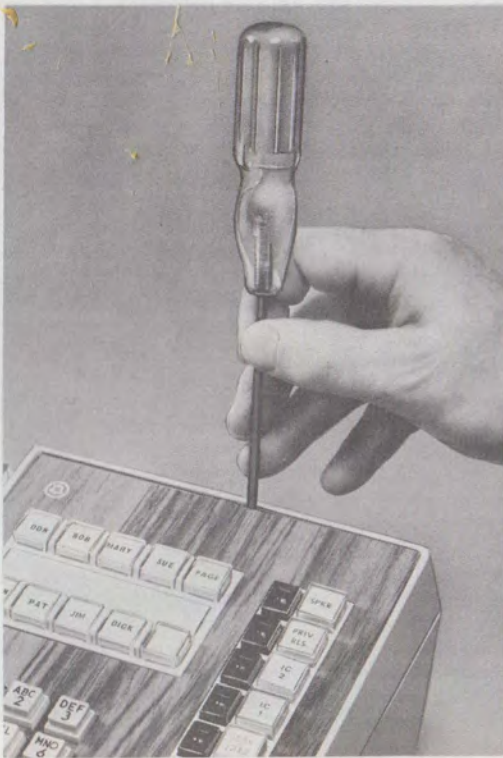

Fig. 53—Removing Faceplate

- (c) Swing the dial down so the left side snaps under the latch on the left side of the opening in the chassis. Dress the dial leads to the left side of the lead guide in the chassis wall (Fig. 5).
- (d) Be sure the dial is level and the latch firmly engaged.
- (e) Test the dial by using it to place a call.
- (f) Replace the DSS key (paragraph 5.24).
- (g) Replace the faceplate (paragraph 5.09).



Conversion between rotary dial and TOUCH-TONE dial changes the set code. Local plant and company practices will dictate whether this



Fig. 54—Installing Faceplate

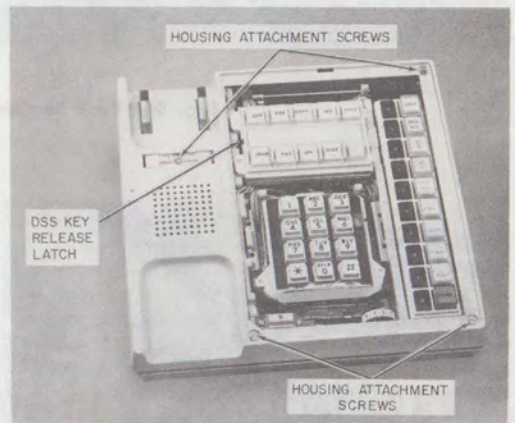

Fig. 55—Basic Satellite Set, Faceplate Removed

option should be exercised. When interchanging dials, the shorting bars in positions A, B, C, and D must be removed to the upper

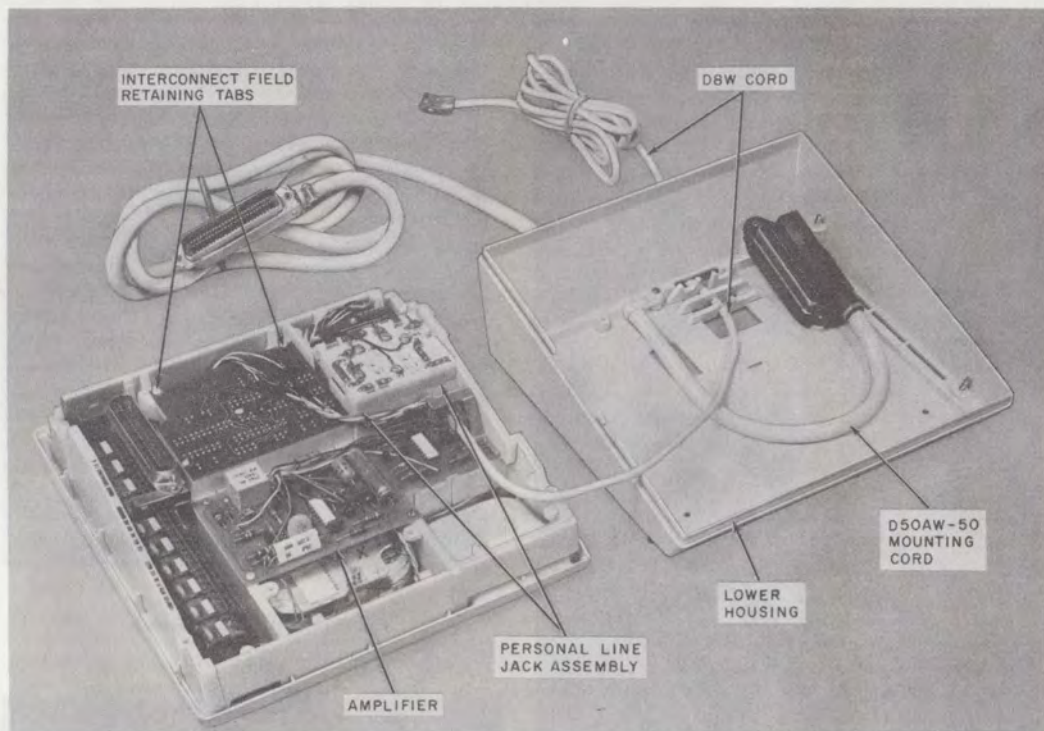

Fig. 56—Basic Satellite Desk Set Disassembled

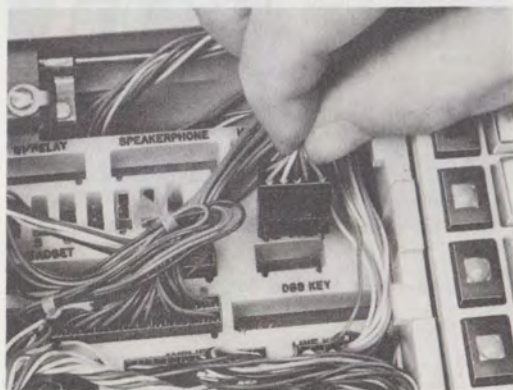

Fig. 57—Unplugging a Component Connector From Interconnect Field

position for rotary dialing or to the lower position for TOUCH-TONE dialing.

C. Loudspeaker Assembly

5.27 To remove the loudspeaker assembly:

- (a) Remove the faceplate (paragraph 5.07) and the upper housing (paragraph 5.10).
- (b) Remove the two noncaptive thread-forming screws which hold the loudspeaker on the chassis (Fig. 5). Save these screws for installing a new loudspeaker.
- (c) Move the DSS key aside to get access to the interconnect field (paragraph 5.23).

(d) Lift the loudspeaker assembly up from the chassis and disconnect its connector from the interconnect field.

5.28 To install the loudspeaker assembly:

- (a) Secure the loudspeaker to the chassis with the same two screws removed in paragraph 5.27(b).
- (b) Dress the leads around the chassis as shown in Fig. 5.
- (c) Plug the connector into the SPKR position of the interconnect field.
- (d) Replace the DSS key (paragraph 5.24).
- (e) Replace the upper housing (paragraph 5.12) and the faceplate (paragraph 5.09).
- (f) On sets where the SPKR button is operative, test the loudspeaker by going off-hook, selecting an idle intercom line, and depressing the SPKR button. Speak into the handset. Listen for normal speech coming from the built-in loudspeaker. On BIS sets or HFAI sets with 4A speakerphone, place an intercom call to these sets from another set.

D. Handset Jack

5.29 The handset jack rests in a slot on the left side of the chassis (Fig. 5). To remove it:

- (a) Remove the faceplate (paragraph 5.07) and the upper housing (paragraph 5.10)
- (b) Move the DSS key aside to gain access to the interconnect field (paragraph 5.23)
- (c) Disconnect the handset cord from the jack
- (d) Lift the handset jack out of its slot and unplug its connector from the interconnect field.

5.30 To install the handset jack:

- (a) Push the jack down into its slot on the left side of the chassis so the opening faces to the left.

(b) Connect the jack connector to the HNDSET position in the interconnect field. (Dress the leads around the right side and front of the loudspeaker.)

- (c) Replace the DSS key (paragraph 5.24).
- (d) Replace the upper housing (paragraph 5.12) and the faceplate (paragraph 5.09).
- (e) Connect the handset cord to the jack.
- (f) Test the handset jack by making a call with the handset.

E. Recall Key

5.31 To remove the recall key:

- (a) Remove the faceplate (paragraph 5.07) and the upper housing (paragraph 5.10).

Warning: Do not remove the two screws on the top of the recall key.

- (b) Pull the key up out of its slots in the chassis (Fig. 5). It will be necessary to move the dial aside to gain access to the key leads (paragraph 5.25).
- (c) Move the DSS key aside to get access to the interconnect field (paragraph 5.23).
- (d) Unplug the recall key connector from the interconnect field.

5.32 To install the recall key:

- (a) Push the key down into the slots in the chassis.
- (b) Plug the connector into the RCL position of the interconnect field. Dress the leads through the opening in the chassis wall near the upper left side of the dial and then under the dial.
- (c) Replace the DSS key (paragraph 5.24) and the dial (paragraph 5.26).
- (d) Replace the upper housing (paragraph 5.12) and the faceplate (paragraph 5.09).

- (e) Test the recall key by going off-hook and depressing the key to break dial tone.

F. Loudspeaker Volume Control

5.33 To remove the loudspeaker volume control:

- (a) Remove the faceplate (paragraph 5.07) and the upper housing (paragraph 5.10)
- (b) Pull the control up out of its slots in the chassis (Fig. 5)
- (c) Move the DSS key (paragraph 5.23) and the dial (paragraph 5.25) aside to gain access to the interconnect field
- (d) Unplug the loudspeaker volume control connector from the interconnect field.

5.34 To install the loudspeaker volume control:

- (a) Push the volume control mounting bracket down into the slots in the chassis
- (b) Plug the connector into the POT position of the interconnect field
- (c) Replace the DSS key (paragraph 5.24) and the dial (paragraph 5.26)
- (d) Replace the upper housing (paragraph 5.12) and the faceplate (paragraph 5.09)
- (e) Test the loudspeaker volume control by adjusting it through its entire range while performing the test described in paragraph 5.28(f).

G. Line Key

5.35 The line key is not repairable in the field and must be replaced if any of the buttons are defective or if any of the LEDs associated with the line and intercom buttons burn out. To remove the line key:

- (a) Remove the faceplate (paragraph 5.07) and the upper housing (paragraph 5.10)
- (b) Loosen the captive screws on each end of the key (Fig. 5), and remove the key collar
- (c) Pull the key upward to disengage it from the connector inside the set

- (d) Move the DSS key aside to gain access to the interconnect field (paragraph 5.23)

- (e) Unplug the two line key connectors from the interconnect field.

5.36 To install the line key:

- (a) Push the latch bar all the way into the upper end of the key so it will engage the ABR shaft properly (Fig. 58).



Fig. 58—Line Key Installation

- (b) Place the key in its proper position on the chassis and push it down so it engages the mating connector inside the set and the latch bar engages the ABR shaft.

- (c) Carefully dress the line key leads through the slot in the chassis wall so they are not pinched or pulled.

- (d) Depress a line button on the key so it locks down; then release it by depressing the ABR shaft at the lever called out in Fig. 5.

- (e) Tighten the two mounting screws.

- (f) Connect the larger line key connector to LINE KEY PLUG A and the smaller connector to LINE KEY PLUG B of the interconnect field.
- (g) Replace the DSS key (paragraph 5.24).
- (h) Replace the upper housing (paragraph 5.12) and the faceplate (paragraph 5.09).

5.37 When the line key has been replaced, test it as follows:

- (a) Go off-hook and operate each CO/PBX line button. Dial tone should be heard on each working line and the associated lamp should light steady. Each button should release and its lamp extinguish when the handset is slowly replaced or when another line button is operated.
- (b) Go off-hook and pick up an idle CO/PBX line. Put it on hold by depressing the HOLD button. The line key should restore and its lamp should wink.
- (c) Go off-hook and operate each intercom button. The lamp associated with each button should light when the button is depressed. Each button should restore and its lamp extinguish when the handset is replaced.
- (d) Go off-hook, simultaneously lock down four line buttons, and then slowly replace the handset. All buttons should release and the lamps extinguish. Repeat for the two intercom buttons.
- (e) If any other set in the system is equipped with privacy, designate the PRIV RLS button and check as described in paragraph 3.54.
- (f) Check the SPKR button by going off-hook, picking up an idle CO/PBX line, and then putting the incoming dial tone on the built-in speaker by operating the button.

H. BIS Module

5.38 To remove the 1A transmitter-receiver module from a BIS satellite set:

- (a) Remove the faceplate (paragraph 5.07) and the upper housing (paragraph 5.10)

- (b) Loosen the four captive screws which hold the module on the chassis
- (c) Move the DSS key aside to gain access to the interconnect field (paragraph 5.23)
- (d) Unplug the 1A module connector from the interconnect field
- (e) Lift the module out of the set.

5.39 To install the 1A module:

- (a) Place the module in its proper position on the chassis, being careful that its latch bar engages the ABR shaft in the same way as the line key latch bar [paragraph 5.36(a) and (b) and Fig. 58]. Make sure that the electret opening on the microphone is completely visible through the lower housing port. Tighten the four captive screws.



When module is installed in wall set, position the microphone by aligning the two white marks on the microphone with the two marks on the wall housing wall.

- (b) Dress the 1A module leads through the guide on the line key (Fig. 58) and plug the connector into the SPEAKERPHONE position of the interconnect field.
- (c) Replace the DSS key (paragraph 5.24).
- (d) Replace the upper housing (paragraph 5.12) and the faceplate (paragraph 5.09).
- (e) Test the 1A module by operating the BIS feature in its normal manner on a CO/PBX call (paragraphs 4.07 through 4.13).

I. HFAI Module

5.40 To remove the HFAI module from an HFAI satellite set:

- (a) Remove the faceplate (paragraph 5.07) and the upper housing (paragraph 5.10)
- (b) Loosen the two captive screws which hold the module to the chassis

- (c) Move the DSS key aside to gain access to the interconnect field (paragraph 5.23)
- (d) Unplug the HFAI module connector from the interconnect field
- (e) Lift the module out of the set.

5.41 To install the HFAI module:

- (a) Attach the module to the chassis of the set with the two captive screws.
- (b) Dress the HFAI module leads through the guide on the line key (Fig. 58) and plug the connector into the HFAI/PWR position on the interconnect field.
- (c) If the system uses only intercom path 1, be sure the shorting bar is mounted on the two pins on the inner left side of the module (Fig. 4). If the system has two intercom paths, remove the shorting bar.
- (d) Replace the DSS key (paragraph 5.24).
- (e) Replace the upper housing (paragraph 5.12) and the faceplate (paragraph 5.09).
- (f) Test the HFAI module by operating the HFAI feature in its normal manner on an intercom call (paragraphs 4.14 through 4.18). If the system has two intercom lines, test the HFAI station on both lines.

J. Amplifier

5.42 To remove the amplifier from a telephone set:

- (a) Disconnect the set from the system. Remove the lower housing of a desk set (paragraph 5.13), or the wall housing of a wall set (paragraph 5.16), or remove the chassis assembly from the base of a primary set as described in paragraph 5.19(a) and (b) to obtain access to the amplifier.
- (b) Detach the amplifier by removing the four screws which hold it to the chassis (Fig. 6 and 56). Save these screws for installing the new amplifier. If the set has a personal line jack assembly bracket attached to the right side of the amplifier, remove it.

- (c) Remove the faceplate (paragraph 5.07).

- (d) Move the DSS key (paragraph 5.23) and the dial (paragraph 5.25) aside and disconnect the amplifier connector from the interconnect field.

- (e) Lift the amplifier away from the set, pulling its cord through the dial opening in the chassis.

5.43 To install the amplifier:

- (a) Position the amplifier on the underside of the chassis with its leads through the dial opening in the chassis. The right side of the amplifier board, as viewed in Fig. 6 and 56, must slide under the retaining tab on the chassis wall. Insert and tighten the four thread-forming screws. If the personal line jack bracket is required, attach it to the amplifier.

- (b) Dress the leads through the guide on the right side of the chassis wall above the dial and plug the connector into the AMPLIFIER position of the interconnect field.

- (c) Replace the DSS key (paragraph 5.24), the dial (paragraph 5.26), and the faceplate (paragraph 5.09).

- (d) Install the lower housing (paragraph 5.15) or the wall housing (paragraph 5.18), or mount the chassis assembly on the primary set base (paragraph 5.20). Connect the set back into the system.

- (e) Test the amplifier by performing the procedure in paragraph 5.28(f). Also use the handset to place an intercom call to another set.

K. Voice-Signaling Interface Circuit

5.44 The voice-signaling interface circuit is a factory-installed board mounted in the two slots on the right side of the opening in the lower left of the chassis of each BIS set. It occupies the same position in BIS sets that the 4A speakerphone relay board occupies in HFAI sets (Fig. 36). To remove a voice-signaling interface board:

- (a) Remove the faceplate (paragraph 5.07) and the upper housing (paragraph 5.10)

- (b) Pull the board up out of its slots in the chassis
- (c) Move the DSS key (paragraph 5.23) and the dial (paragraph 5.25) aside to gain access to the interconnect field
- (d) Unplug the connector of the voice-signaling interface board from the interconnect field.

5.45 To install a voice-signaling interface board:

- (a) Push the board down into the slots in the chassis with its components to the left.
- (b) Move the dial aside (paragraph 5.25) and dress the leads of the board through the slot in the chassis wall and under the left side of the dial.
- (c) Replace the dial (paragraph 5.26).
- (d) Plug the board connector into the VSI/RELAY position on the interconnect field. Dress the leads toward the front of the set to prevent interference with the ABR shaft.
- (e) Replace the DSS key (paragraph 5.24).
- (f) Replace the upper housing (paragraph 5.12) and the faceplate (paragraph 5.09).

5.46 Test the voice-signaling interface circuit as follows:

- (a) Set the speakerphone volume control to a low level and the voice-signaling loudspeaker volume control to a high level.
- (b) Using the handset and an idle IC line, voice signal from the BIS station on its own DSS code. The voice signaling should be heard from the set loudspeaker, but not from the speakerphone.
- (c) Repeat the procedure of (b) using the speakerphone instead of the handset.
- (d) Release the DSS button, then depress it again and voice signal again. Voice signaling should now be heard from both the set loudspeaker and the speakerphone.

L. Interconnect Field Assembly

5.47 If any of the connector pins on the interconnect field are damaged or bent beyond repair, the entire assembly can be replaced. To remove the interconnect field:

- (a) Remove the faceplate (paragraph 5.07).
- (b) Remove the DSS key from the telephone (paragraph 5.23).
- (c) Unplug all the component connectors from the interconnect field.
- (d) Turn the telephone over.
- (e) Remove the lower housing of a desk set (paragraph 5.13), the wall housing of a wall set (paragraph 5.16), or the base and logic assembly from a primary set (paragraph 5.19) to get access to the set amplifier and the back of the interconnect field.
- (f) Remove the four screws which hold the amplifier on the chassis.
- (g) Move the amplifier enough to free the front edge of the interconnect field. On basic satellite and HFAI sets with personal line, it will also be necessary to move the jack assembly bracket (Fig. 43).
- (h) Lift the interconnect field out of the chassis.

5.48 Install a new interconnect field of the correct code (see ORDERING GUIDE) in the telephone as follows:

- (a) Insert the interconnect field assembly into the chassis with its rear edge under the two retaining tabs (Fig. 56).
- (b) Move the amplifier back into its proper position with its rear edge over the interconnect field and secure it to the chassis with the four screws. If a personal line jack assembly bracket was removed, attach it again.
- (c) Install the lower housing (paragraph 5.15), wall housing (paragraph 5.18), or base and logic assembly (paragraph 5.20).
- (d) Turn the telephone over.

(e) Plug all of the component connectors into the interconnect field. **Be sure the shorting bars of the interconnect field are in their correct positions (Fig. 37).**

(f) Replace the DSS key (paragraph 5.24).

(g) Replace the faceplate (paragraph 5.09).

M. Base and Logic Assembly

5.49 The base and logic assembly in primary sets is removed and replaced as described in

paragraphs 5.19 and 5.20. The entire base and logic assembly, not including the power transformer and the D50AB mounting cord, must be replaced. When a new assembly is installed, test it by placing and receiving calls on the intercom and CO/PBX lines served by that primary set. Also check the hold function and line status indications.

N. Power Transformer

5.50 The transformer is removed and replaced as described in paragraph 3.33(a) and (f).