

## "PICTUREPHONE®" SERVICE (PHASE 0) 2C VIDEO TELEPHONE STATION IDENTIFICATION AND INSTALLATION

### 1. GENERAL

**1.01** A 2C Video Telephone Station is the descriptive nomenclature assigned to a group of components which provide PICTUREPHONE® service at a customer location. All components must be ordered individually. A 2C Video Telephone Station consists of the following components:

- 1A Display Unit
- 72A Control Unit
- 1A Service Unit
- 55D Control Unit
- FW1, FW2, or FW3 Circuit Pack.

In addition, a D50AF cord, a telephone set equipped with a 12-button TOUCH-TONE® dial capable of being wired for speakerphone in the on-hook position and a 939A or B cable equalizer or an 877A or B network is required. (See Ordering Guide.)

**1.02** This section is reissued to:

- Add information on 72A control unit and FW3 circuit pack
- Revise Tables B, C, and D.

Changes or additions in the body of tables are indicated by shaded areas.

**1.03** This issue of the section is based on the following drawings:

CD- and SD-69620-01, Issue 3A

CD- and SD-1C348-01, Issue 3A.

If this section is to be used with equipment or apparatus reflecting later issues of the drawings, reference should be made to the SDs and CDs to determine the extent of the changes and the manner in which the section may be affected.◆

**1.04 1A Display Unit (Fig. 1):** Contains the camera, display tube, and their associated circuitry, speakerphone loudspeaker, and a tone ringing sounder for incoming video call alerting. Weight: approximately 25 lbs. These units are available in color. See Table A.



**Fig. 1—1A Display Unit**

**1.05 72A Control Unit (Fig. 2):** Contains the controls for operation of the 1A display unit and the speakerphone. Weight: approximately 1/2 lb. This unit is available in the same colors as the display unit.

**Note:** It is recommended that all 72A control units manufactured or repaired prior to March, 1971 be replaced, either by new units date-stamped 3-71 or later, or by repaired units date-stamped R3-71 or later.

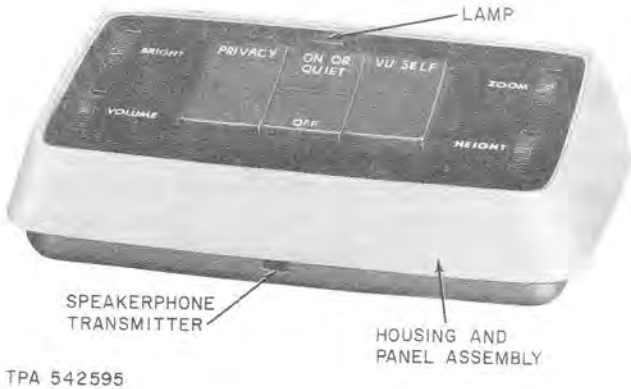

Fig. 2—72A Control Unit

**1.07 55D Control Unit (Fig. 4):** Dimensions are 8-7/32 inches wide by 4-13/32 inches deep by 8 inches high. Weight: approximately 5-1/2 lbs. Contains the circuits required for speakerphone operation. Power for the 55D control unit may be provided from the 1A service unit or from a 2012B transformer.

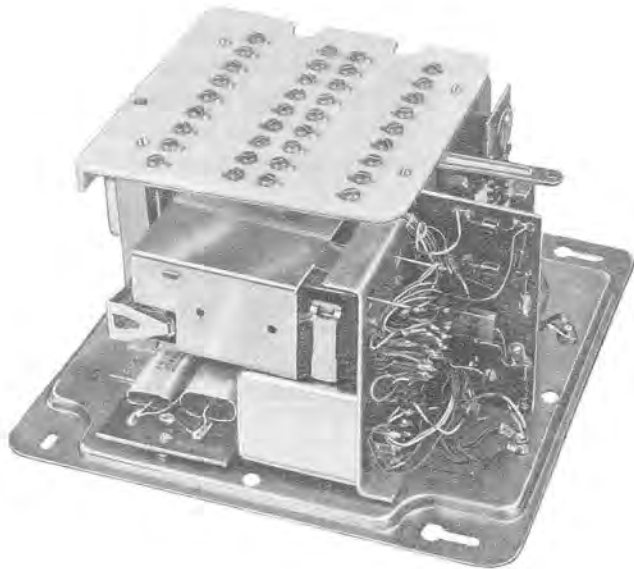

Fig. 4—55D Control Unit

**1.06 1A Service Unit (Fig. 3):** Contains the power supply for the 1A display unit, additional circuitry not included in the display and control units, and provisions for terminating the cabling from the display unit, the 55D control unit, 72A control unit, and the video and audio circuits. Weight: approximately 17 lbs. A power cord must be ordered separately. See Ordering Guide.

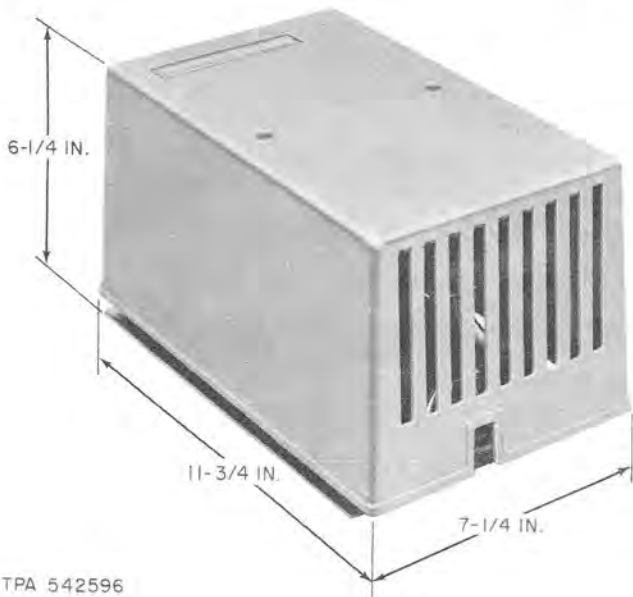

Fig. 3—1A Service Unit

**1.08 D50AF Cord (Fig. 5):** Connects the 1A display unit with the 72A control unit and 1A service unit. Cord is 10 feet long and is available in color.

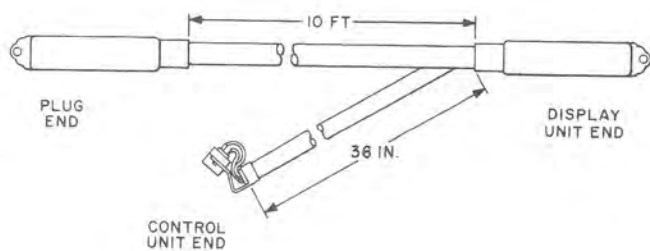

Fig. 5—D50AF Cord

**TABLE A**  
**COLOR ORDERING GUIDE**

APPARATUS	BLACK 03	LT. OLIVE GRAY 49	IVORY 50	MOSS GREEN 51	WHITE 58	LT. BEIGE 60	LT. GRAY 61
Cord, D50AF —	•		•	•	•	•	•
Cover, P88KO	•		•	•	•	•	•
Set, Telephone	•		•	•	•	•	•
Unit, Control, 55D —		•					
Unit, Control, 72A —	•		•	•	•	•	•
Unit, Display, 1A —	•		•	•	•	•	•
Unit, Service, 1A —		•					

**1.09** ♦ *FW1, FW2, or FW3 Circuit Pack (Fig. 6)*: Contains  $\pm 17$ -volt regulators which furnish power to the video circuits during a PICTUREPHONE call. FW1 is used in conjunction with the 1P2 Key Telephone System and FW2 is used with the single line station. (See Tables B, C, and D). FW3 is used when the 2C Video Telephone Station is behind a 101A ESS PBX for a single line installation, or is used as a maintenance set at a No. 5 crossbar central office.♦

**1.10** *Telephone Sets*: The 2500S and 2660-type are typical telephone sets which may be used with the 2C Video Telephone Station. The 2565- and 2662-types are typical 6-button key telephone sets which may be used with the 2C Video Telephone Station when it is used with the 1P2 Key Telephone System.

**1.11** When PICTUREPHONE service is furnished from a foreign exchange to a rotary dial location, a 1035C3A adjunct dial is required. See Section 501-164-130 for additional information.

**1.12** *A single line station* is a 2C Video Telephone Station served by an individual line having no association with a 1P2 Key Telephone System. *A key telephone station* is a 2C Video Telephone Station served by one or more video, CO, Centrex, PBX or intercom lines associated with a 1P2 Key Telephone System.

## 2. IDENTIFICATION

### PURPOSE

To provide audio and video communications with other similarly equipped stations.

### APPLICATION

- Individual central office, foreign exchange, Centrex, or PBX lines where serving central office, Centrex, or PBX has been modified for PICTUREPHONE service
- 1P2 Key Telephone Systems containing:
  - Lines as previously outlined and/or
  - Dial Selective Intercom Arrangements.

**SECTION 518-800-110**

**ORDERING GUIDE**

- Cord, D50AF-\*
- Equalizer, Cable, 939A‡
- Equalizer, Cable, 939B †
- Network, 877A †
- Network, 877B †
- Pack, Circuit, FW1†
- Pack, Circuit, FW2‡
- Pack, Circuit, FW3 (See 1.09)
- Cord, Power (one required for 1A service unit)  
P-40J326, 1-1/2 ft.  
P-40J327, 2 ft.  
P-40J328, 4 ft.  
P-40J329, 6 ft.  
P-40J099, 12 ft.
- Set, Telephone \*(See 1.01 and 1.10)  
  
Diode, 446F or 400J (One per key telephone set arranged for add-on conference, station busy tone and/or busy station audible cutoff. Refer to appropriate telephone set connection section.  
  
Lamp, KS-20673, L1 (One per video line appearance).
- Unit, Control, 55D-\*
- ♦Unit, control, 72A - \* (Date of manufacture or repair should be stamped "3-71" or later. See 1.05.)♦
- Unit, Display, 1A-\*
- Unit, Service, 1A-\*

\* Refer to Table A for color selection.

(a) *Replaceable Components*

- Cord, D50AF-\*
- Set, Telephone-\*
- Lamp, KS-20673,L1
- Unit, Control, 55D-\*
- Unit, Control, 72A-\*
- ♦ Assembly, Housing and Panel  
    840173033 (Black)  
    840173504 (Ivory)  
    840173587 (White)  
    840173603 (Light Beige)  
    840173611 (Light Gray)♦  
    Lamp, 370 (G.E. Part No.)
- Unit, Display, 1A-\*
- Assembly, Housing  
    840298038 (Black)  
    840298509 (Ivory)  
    840298517 (Moss Green)  
    840298582 (White)  
    840298608 (Light Beige)  
    840298616 (Light Gray)  
    P-88K0-\*, Cover
- Unit, Service, 1A \*  
    Equalizer, Cable, 939A‡  
    Equalizer, Cable, 939B†  
    Fuse, 24C (2A)  
    Fuse, 24D (3/4A)  
    Network, 877A†

Network, 877B†	} Cord, Power (one required)
P-40J326, 1-1/2 ft.	
P-40J327, 2 ft.	
P-40J328, 4 ft.	
P-40J329, 6 ft.	
P-40J099, 12 ft.	
Pack, Circuit, FW1†	
Pack Circuit, FW2 ‡	
Pack Circuit, FW3 (see 1.09)	

Refer to Table A for color selection.

(b) *Associated Apparatus (order separately if required)*

- Adapter, 149B
- Block, Connecting, 44A
- Block, Connecting, 57A2A-6
- Block, Connecting, 57A2B-10
- Block, Connecting, 57A2B-16
- Block, Connecting, 66E3-25
- Block, Terminal, 1A4A
- Cable, Connector, A25B
- Cable, Connector, A25M §
- Cable, Connector, B25A
- Cord, W2GNP ¶
- Dial, 1035C3A
- Fuse, 60A
- Fuse, 60D
- Holder, Fuse, 14A
- Protector, 134A1A
- P-46L859 Terminal Block Assembly
- Transformer, 2012B
- Unit, Protector, 2A1D.

† For key telephone stations see Table B for selection.

‡ For single line stations.

§ Use when shielded cable is required. Length must be specified on order.

¶ When 2C Video Telephone Station is used as a maintenance set (3.20).

(c) *Customer Instruction Booklet, S1B-2460 on PICTUREPHONE Service (order separately)*

## DESIGN FEATURES

### 1A Display Unit (Fig. 1)

- Free standing
- Rotates 340 degrees
- Arranged to provide transmission of graphic material by transmitting image reflected in mirror on underside of GRAPHIC VISOR
- Automatic compensation for varying light conditions
- Glass will not shatter if display tube implodes
- Designed not to tip over easily
- Mechanical tilt adjustment of 5 degrees.

### 72A Control Unit (Fig. 2)

- ON OR QUIET—Controls speakerphone operation when handset is on-hook, disables speakerphone transmitter when depressed
- PRIVACY—Causes camera to transmit a horizontal bar image (Fig. 7) in place of picture
- VU SELF—Allows user to check image being transmitted
- OFF—Turns speakerphone off and restores VU SELF and PRIVACY buttons to normal
- BRIGHT—Controls brightness on screen of display unit
- VOLUME—Controls loudspeaker volume

TABLE B

**1A SERVICE UNIT NETWORK SELECTION  
FOR STATION ASSOCIATED WITH 1P2 KTS  
(USING FW1 CIRCUIT PACK)**

CABLE GAUGE & TYPE \ NETWORK	CABLE LENGTH (FEET) KTS TO 1A DISPLAY UNIT*			
	877A NETWORK A	877B NETWORK B	877A NETWORK C	877B NETWORK D
22 Pulp	Up to 130	131-230	231-330	331-430
24 Pulp	Up to 120	121-220	221-320	321-420
26 Pulp	Up to 140	141-250	251-350	351-440
22 PIC	Up to 180	181-320	321-460	461-600
24 PIC	Up to 180	181-310	311-450	451-580
26 PIC	Up to 190	191-330	331-460	461-580
24 252A Swbd Cable	Up to 140	141-260	261-380	381-500
24 D-Type Inside Wire	Up to 125	126-225	226-325	326-425
22 D-Type Station Wire	Up to 165	166-315	316-465	466-615
22 ABAM	Up to 190	191-340	341-490	491-620
24 CA 3217	Up to 220	221-390	391-540	541-670
24 DL Wire	Up to 160	161-280	281-410	411-530
24 ABMM	Up to 190	191-340	341-480	481-610

\* When cable length exceeds those shown in this table use 939B cable equalizer and externally mounted 607A KTU on station side of KTS in common pair as close as is practical to KTS equipment in place of network and refer to Table C for Screw Switch Settings. Length should include cable between 1A Service Unit and 1A Display Unit.

- ZOOM—Controls size of image being transmitted
- HEIGHT—Allows camera image to be vertically adjusted enabling user to center picture being transmitted
- LAMP—Lights when speakerphone is turned on.

#### 1A Service Unit (Fig. 3 and 8)

- Wall mounted (bracket furnished)
- Interconnects 1A display unit, 72A control unit, and 55D control unit with audio and video lines
- Contains power supply and fuses for audio and video functions

- Provides plug-in mounting facilities for circuit packs, cable equalizers and/or buildout networks.

### 3. INSTALLATION

#### PLANNING

**3.01** Certain conditions concerning lighting should be considered when locating a 2C Video Telephone Station.

- (a) Avoid spotlights and other very bright overhead lights as they usually cause glare on the user's head, face, and glasses.
- (b) Avoid locations where the camera is tilted upward and the view is across the long dimension of a large room, since the camera may pick up ceiling light, causing impairment of the picture.

TABLE C

**939B CABLE EQUALIZER AND EXTERNALLY MOUNTED 607A CABLE EQUALIZER  
SCREW SWITCH SETTINGS FOR STATION ASSOCIATED WITH  
1P2 KTS (USING FW1 CIRCUIT PACK NOTE 1)**

CABLE GAUGE AND TYPE	SCREW SWITCH SETTING (NOTE 3)	CABLE LENGTH (FEET) KTS TO 1A DISPLAY UNIT (NOTE 2)		
		S	M	M and L
22 Pulp		430-3100	3101-5800	5801-8400
24 Pulp		420-2600	2601-4800	4801-7100
26 Pulp		440-2200	2201-4000	4001-6200
22 PIC		600-3800	3801-7300	7301-10,400
24 PIC		580-3200	3201-6000	6001-9000
26 PIC		580-2600	2601-4700	4701-7400
24 252A Swbd Cable		500-2800	2801-5200	5201-7700
24 D-Type Inside Wire		420-2400	2401-4500	4501-6700
22 D-Type Station Wire		610-3400	3401-6500	6501-9500
22 ABAM		620-4300	4301-8000	8001-11,500
24 CA 3217		670-3600	3601-6500	6501-9600
24 DL Wire		530-3000	3001-5600	5601-8300
24 ABMM		610-3300	3301-6000	6001-8900

**Notes:**

1. This table applies to the 607A KTU *only* when used on the station side of the KTS. In this application, the SS switch on the 607A KTU should be closed.
2. Use this table only when distance from 1P2 KTS exceeds limits of 877B network used in D position (Table B).
3. Close screw switch (S, M or L) associated with length and gauge of cable used and make certain remaining screw switch(es) (S, M, L) are open.

TABLE D

**939A CABLE EQUALIZER SCREW SWITCH SETTINGS FOR STATION NOT  
ASSOCIATED WITH 1P2 KTS (USING FW2 CIRCUIT PACK)**

CABLE GAUGE AND TYPE	SCREW SWITCH SETTINGS *	CABLE LENGTH (FEET) FROM PRECEDING CABLE EQUALIZER TO 1A DISPLAY UNIT		
		S	M	M and L
22 Pulp		Up to 2700	2701 to 5400	5401 to 8100
24 Pulp		Up to 2200	2201 to 4400	4401 to 6700
26 Pulp		Up to 1800	1801 to 3600	3601 to 5800

\* Close screw switch (S, M, or L) associated with length and gauge of cable used and make certain remaining screw switch(es) (S, M, L) are open).

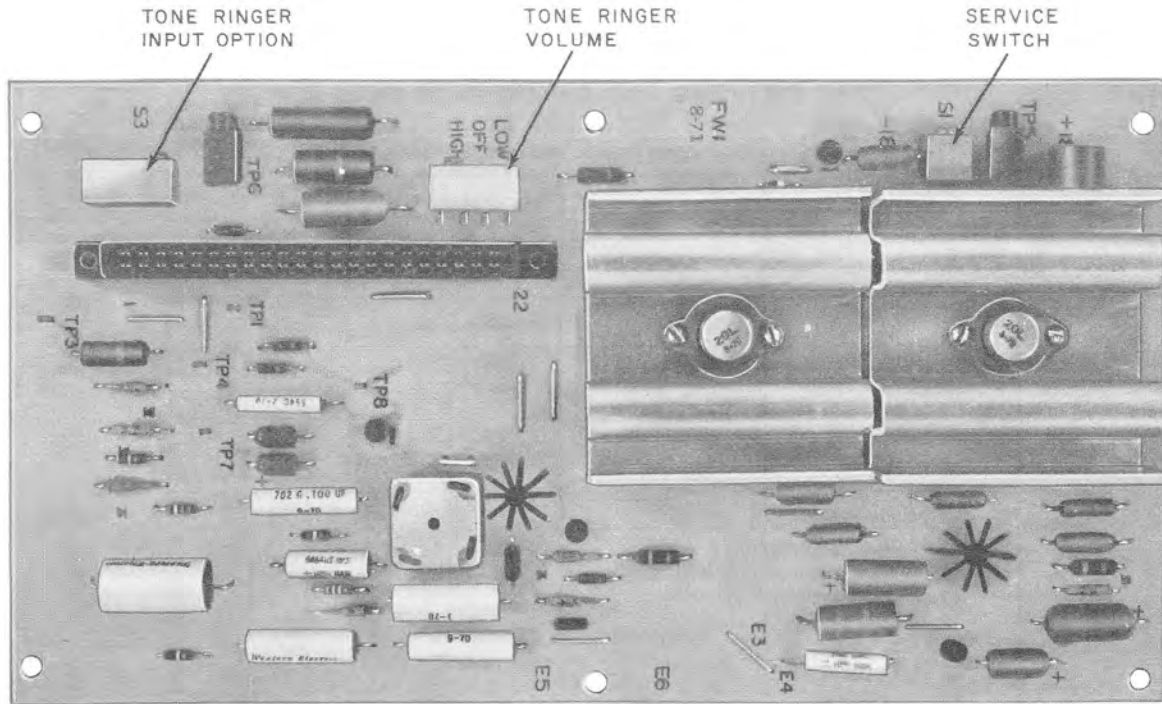

FW1

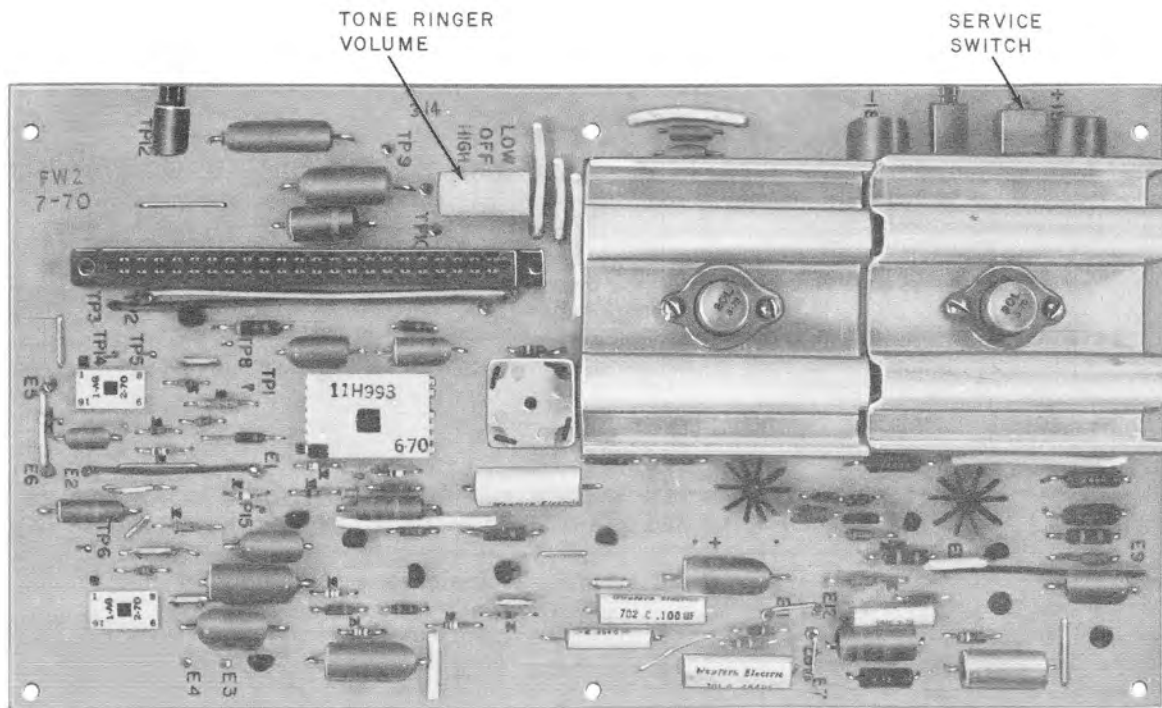

FW2

TPA 542619

◆ Fig. 6—FW-Type Circuit Packs ◆





**Fig. 7—Horizontal Bar Image on Display Unit With 72A Control Unit in Privacy Mode**

- (c) Overhead lighting may be satisfactory if sufficient light is reflected from the ceiling and walls to provide uniform face and eye lighting.
- (d) Avoid bright light sources directly in the field of view of the camera such as windows and lamps as they will appear as light areas while user's face appears very dark.
- (e) Avoid locations where there is unequal lighting or insufficient front lighting since this results in dark shadows about the face or eyes.
- (f) Normally, good lighting is obtained where the user faces a window to view the display unit. Semitransparent drapes are helpful in those cases where bright sunlight shines through the windows. Installation of the display unit on a table or at the back of a desk against a window, or on a table against a window at the side of the desk will normally provide this lighting.

**3.02** It may be necessary to adjust the tilt of the display unit to eliminate ceiling light or to permit centering of the image (See 3.34).

**3.03** The display unit is designed to operate in an air conditioned environment and is sensitive to heat. The display unit should not be located:

- On ledges above heating devices
- On cabinets housing heating devices
- Where it would be continuously in the sun.

**3.04** Avoid locations where the cabling cannot be concealed or securely and neatly fastened.

**3.05** Fig. 9 is a typical installation layout of a single line station and Fig. 10 is a typical installation layout of a key telephone station.

**3.06** Planning the installation of a video key telephone station is related to the overall planning of a 1P2 Key Telephone System since the distance between the 1A display unit and the equipment bay or KSU has a direct effect on the apparatus and cabling requirements for the key telephone station.

**3.07** When the location of the equipment bay or KSU is less than 85 feet (cable length) from the 1A display unit, it may be advantageous to locate the 1A service unit and the 55D control unit in the equipment area (Fig. 10 and 11). For this arrangement, one A25B connector cable is required to extend the telephone set mounting cord to the 66-type connecting blocks and one B25A connector cable (maximum of 75 feet long) is required to extend the D50AF cord from the 1A display unit to the 1A service unit.

**3.08** When the location of the equipment bay or KSU is more than 85 feet (cable length) from the 1A display unit, the 1A service unit and 55D control unit must be located at the customer station location (Fig. 12). For this arrangement a 149B adapter or 66E3-25 connecting block plus a 25-pair cable of the required length is used to connect from the station location to the key equipment area.

**Note:** The maximum audio station loop resistance is 50 ohms.

TOP

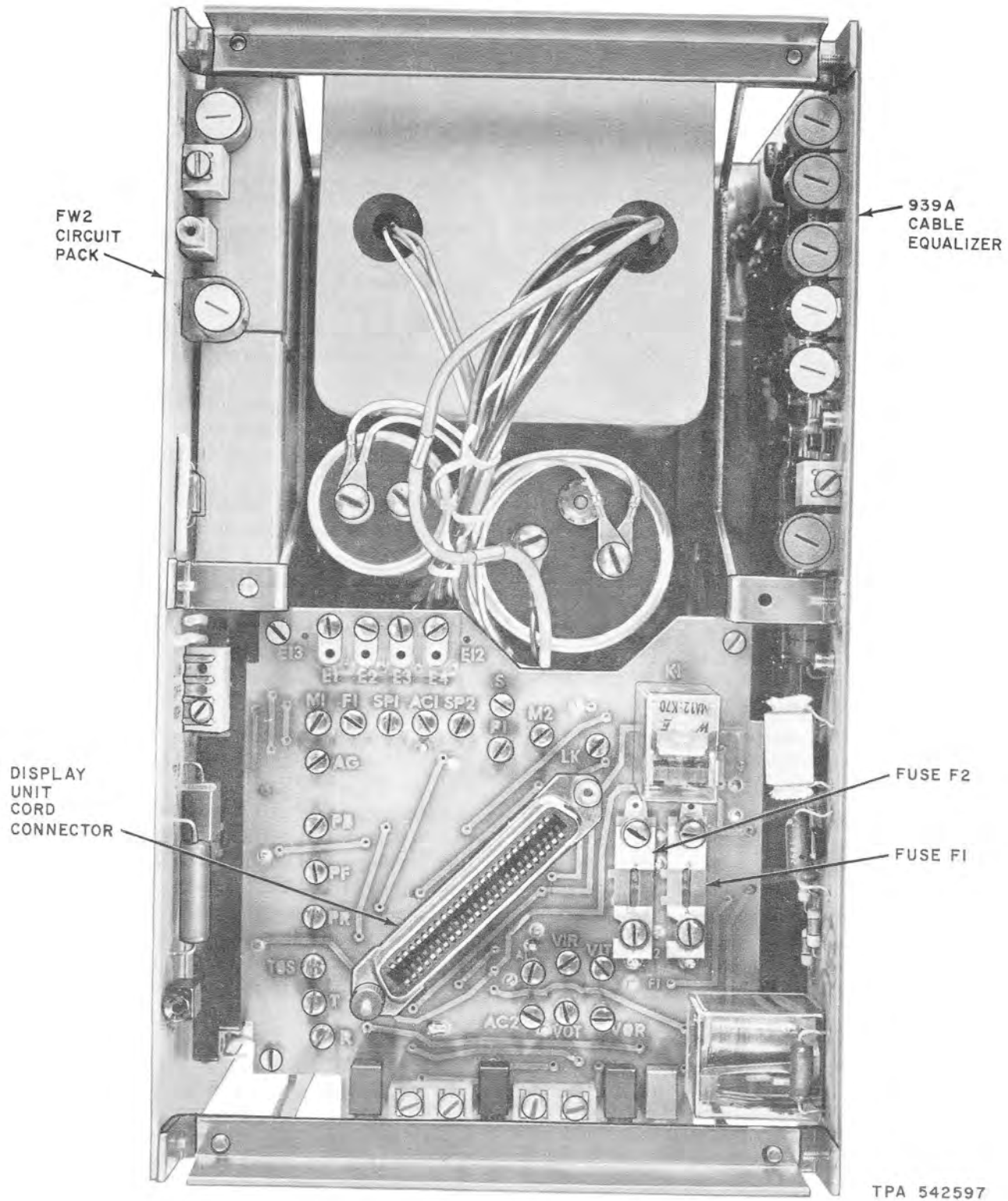

◆ Fig. 8—1A Service Unit, Front View, Cover Removed ◆

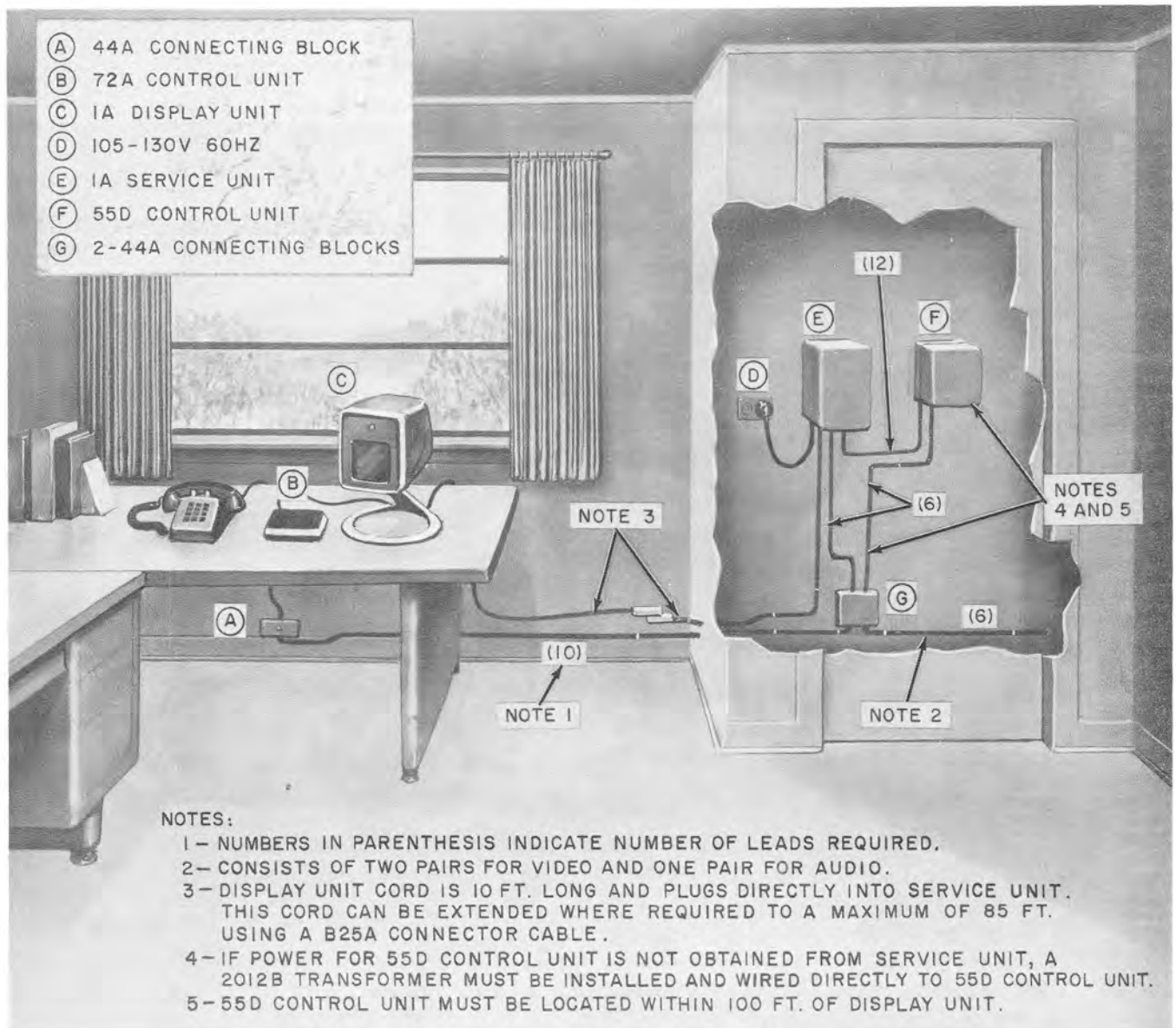

Fig. 9—Typical Installation of Single Line Station

**3.09** If there is any possibility of electrical interference, the A25M (shielded) connector cable should be used in place of the A25B connector cable.

**3.10** All switching of video pairs, tone ringer sounder, turn-on-set and power failure leads is done in the key equipment. Therefore, these leads are extended only once to each 1A service unit regardless of the number of video lines picked up at the station. **Each audio pair which is picked up by a station must be extended on**

**a per line basis to that station. "A" leads also must be extended on a per line per station basis. They may not be multiplied between video stations or between audio and video stations.**

#### POWER

**3.11** The 1A service unit must be mounted within power and cord length of a customer-provided 105-130V, 60 Hz, 3-wire ac power receptacle. (See Ordering Guide for power cord lengths.)

TPA 542697

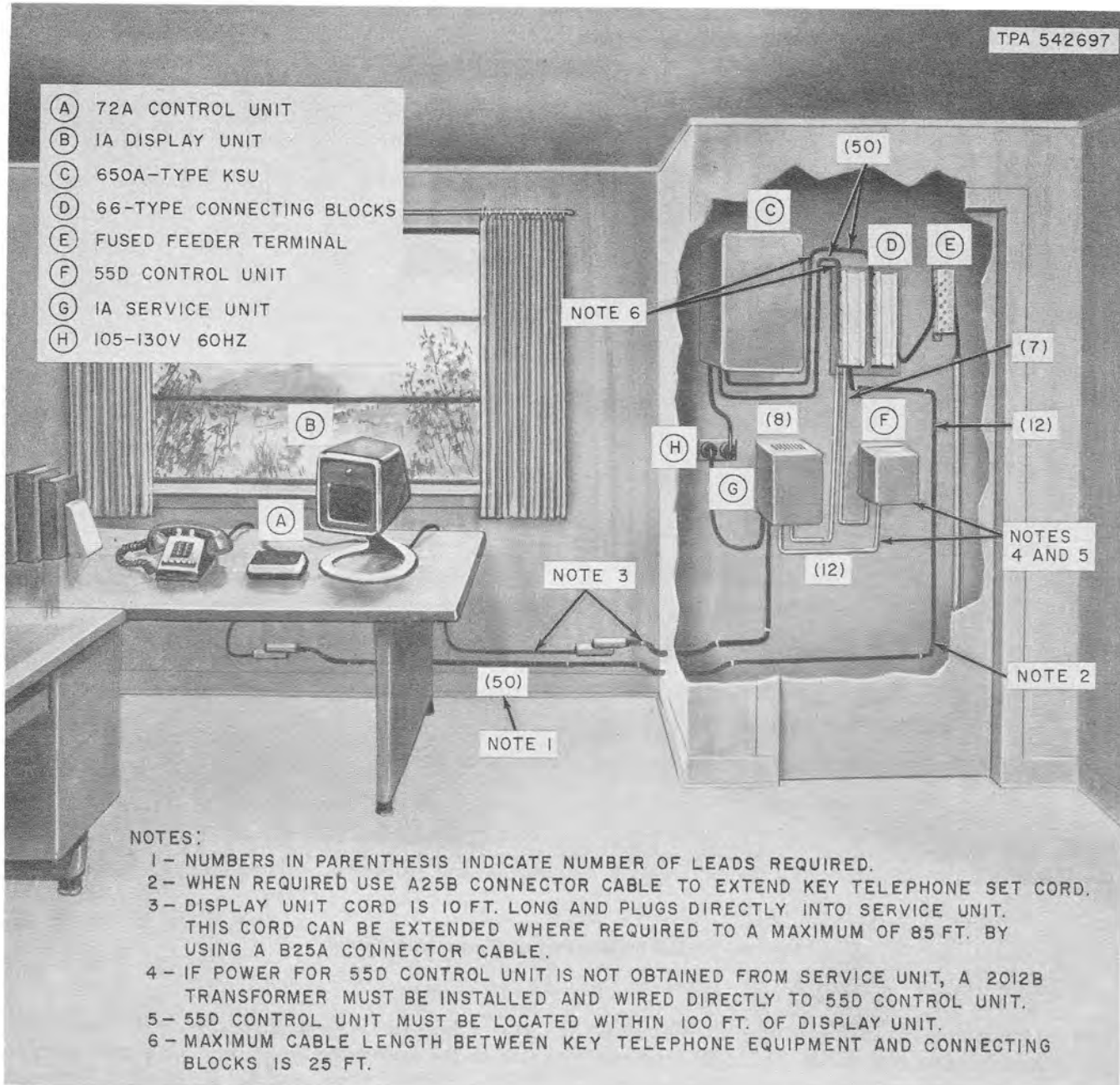
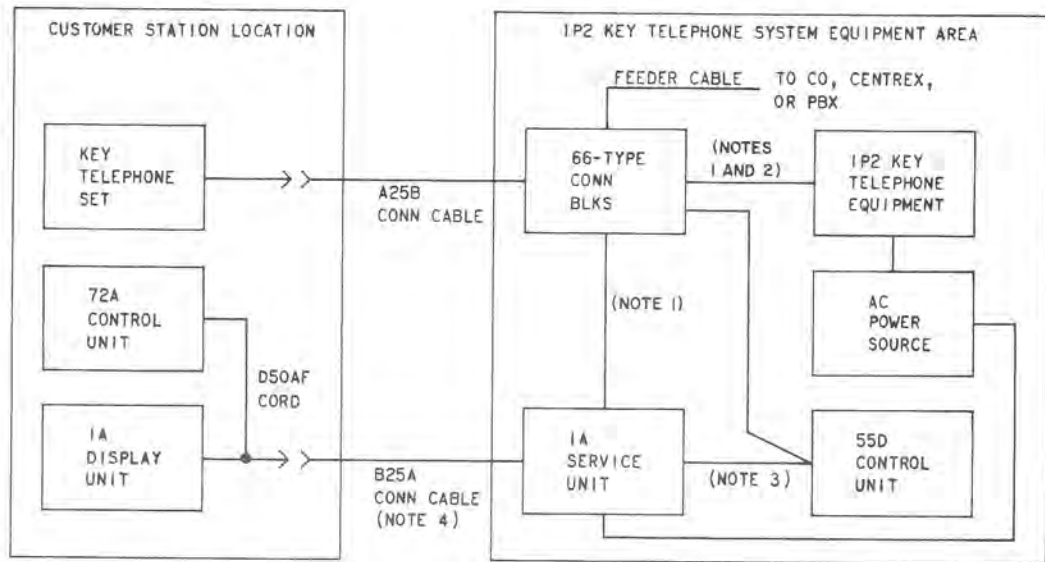
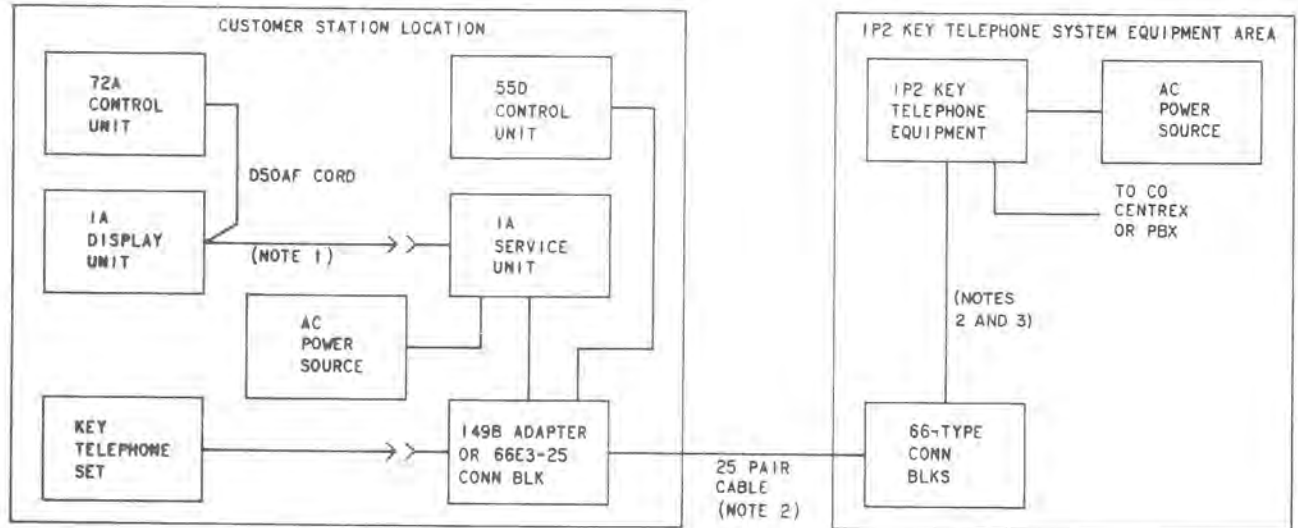

Fig. 10—Typical Installation of Key Telephone Station



- NOTES:
1. SEE TABLE B FOR LENGTH AND SELECTION OF THIS CABLE.
  2. MAXIMUM CABLE LENGTH BETWEEN KEY TELEPHONE EQUIPMENT AND CROSS CONNECT FIELD (CONNECTING BLOCKS) IS 25 FEET.
  3. MAXIMUM CABLE LENGTH BETWEEN 55D CONTROL UNIT AND 1A DISPLAY UNIT IS 100 FEET.
  4. MAXIMUM CABLE LENGTH BETWEEN 1A DISPLAY UNIT AND 1A SERVICE UNIT IS 85 FEET.

Fig. 11—Block Diagram of a Key Telephone Station With a 1A Service Unit and 55D Control Unit Mounted in the Key Telephone System Equipment Area



- NOTES:
1. IF DISTANCE (CABLE LENGTH) IS OVER 10 FEET, ADD A LENGTH OF B25A CONNECTOR CABLE NOT TO EXCEED 75 FEET.
  2. SEE TABLE B FOR LENGTH AND SELECTION OF THIS CABLE.
  3. MAXIMUM CABLE LENGTH BETWEEN KEY TELEPHONE EQUIPMENT AND CROSS-CONNECT FIELD (CONNECTING BLOCKS) IS 25 FEET.

Fig. 12—Block Diagram of a Key Telephone Station With 1A Service Unit and 55D Control Unit Located at the Customer Station Location

**3.12** The power receptacle supplying the 1A service unit must not be under control of a switch and should be on a separately fused power circuit. Where local instructions permit, secure the power cord to the receptacle with a power cord plug retainer assembly.



**PICTUREPHONE cable equalizers may be damaged if foreign voltage is accidentally applied to the video pairs. Protection measures require that fuses be installed on video pairs on the outside (Plant side) of the PICTUREPHONE cable equalizers located in PBXs, KTS and non-KTS station set service units. Dedicated cable and/or special service protection (refer to Section 460-110-100) should be provided between PBX, KTS and station sets to prevent the accidental application of hazardous potentials within the building cable. Intermediate equalizers on customer premises should have 60-type fuses in series with tip and ring of the video pairs which terminate at the input and output of the equalizers when exposure to foreign potential is present.**

**3.13** Fuses are required for PICTUREPHONE equalizers located on customer premises for both exposed and unexposed underground plant. To obtain required protection in the building cable, these fuses should be located as close as is practical to the equalizers. The methods for providing the necessary protection with 60-type fuses are as follows:

- (a) For unexposed plant, mount 60D fuses with 14A fuse holders on a 57A2A-6 (Fig. 13), 57A2B-10, or 57A2B-16 connecting block equipped with 2AID (dummy) protector units. **The fuses should be located as close to the equalizers as is practical.**
- (b) For exposed plant with the station protection location at the building entrance terminal, add the fuses separately, close to the equalizers, as in (a).
- (c) For exposed plant with existing station protected terminals equipped with binding posts, mount the 60D fuses with 14A fuse holders on the existing protected terminal blocks.

- (d) For new construction with exposed plant, the 134A1A protectors or 1A4A-type terminal blocks should be used to provide station protection. Add the required fuses as in (b) or (c).

- (e) As an alternate method for (a), 60A fuses mounted on 57A2-10 or 57A2-16 connecting blocks or on a P46L859 terminal block assembly (a piece part of the 104-type wire terminal) may be used. It is recommended that only every other binding post be used to provide adequate separation between the 60A fuse spade tips.

#### UNCRATING

**3.14** Packing cases should be handled in accordance with local instructions.

#### INSTALLING

##### 1A Service Unit



**The 1A service unit must be located within 85 feet of the 1A display unit. This includes the D50AF cord (10-feet) from the 1A display unit and up to 75 feet of B25A connector cable.**

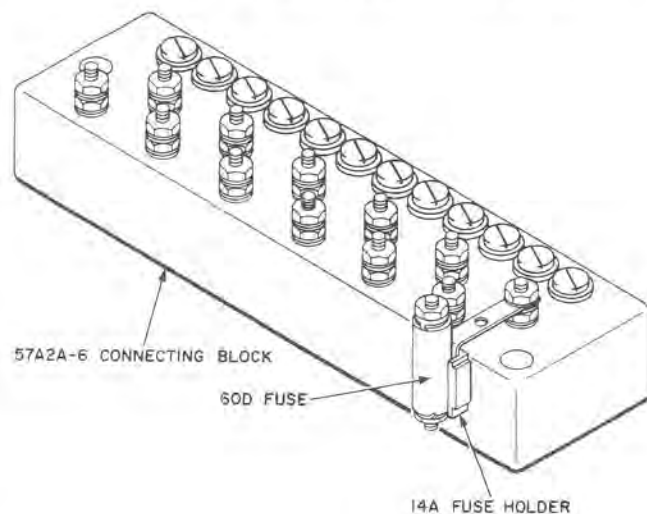

**Fig. 13—Method of Fusing for PICTUREPHONE Equalizer**

**3.15** Separate 1A service unit (Fig. 14) from mounting bracket (Fig. 15).

**3.16** Install mounting bracket (Fig. 15) vertically on wall (or suitable vertical surface) using appropriate fasteners for the weight of the unit.

Refer to appropriate section in Division 080 for selection and installation of fasteners. The 1A service unit should not be installed in an unventilated enclosure.

**3.17** Select FW1 or FW2 circuit pack (Fig. 6), 939A or B cable equalizer (Fig. 16 and 17), or 877A or B network (Fig. 18) according to the type of service, length, type, and gauge of cable as outlined in Tables B, C, and D. Use an FW3 circuit pack if the 2C Video Telephone Station is for a single line installation behind a 101 ESS PBX or is used as a maintenance set at a No. 5 crossbar central office.

**3.18** If FW1 circuit pack (Fig. 6) is used, adjust screw switches as follows:

- S1 (Service Switch)—screw tightened down
- S2 (tone ringer volume)—adjust by placing the screw in one of the three switch positions (HI, LO, OFF) provided on the circuit pack
- S3 (tone ringer input option)—screw is placed and tightened down in switch position A for KTS common audible ringing diode matrix, and in switch position B for all other ringing options.

**3.19** Screw switches on FW2 and FW3 circuit packs are adjusted in the same way as on FW1 except that FW2 and FW3 circuit packs do not have an S3 switch.

**3.20** The FW3 circuit pack has two screw terminals, designated CG and CS, for use when the 2C Video Telephone Station is used as a maintenance set. A W2GN cord (see SD-25762-01 for additional information) is connected to these terminals to turn on the 2C Video Telephone Station and remove loopback.

**3.21** Install the selected circuit pack in 1A service unit using mounting screws provided.

**3.22** The 939A or B cable equalizers (Fig. 16 and 17) have screw switches marked S (Short), M (Medium), and L (Long). These switches are opened or closed depending on the length, type, and gauge of the cable as shown in Tables C and D. To open a switch, turn the screw two turns counterclockwise. To close a switch, turn the screw clockwise until tight.

**3.23** Install 939A or B cable equalizer or 877-type network (whichever is required) in the 1A service unit with the mounting screws provided.

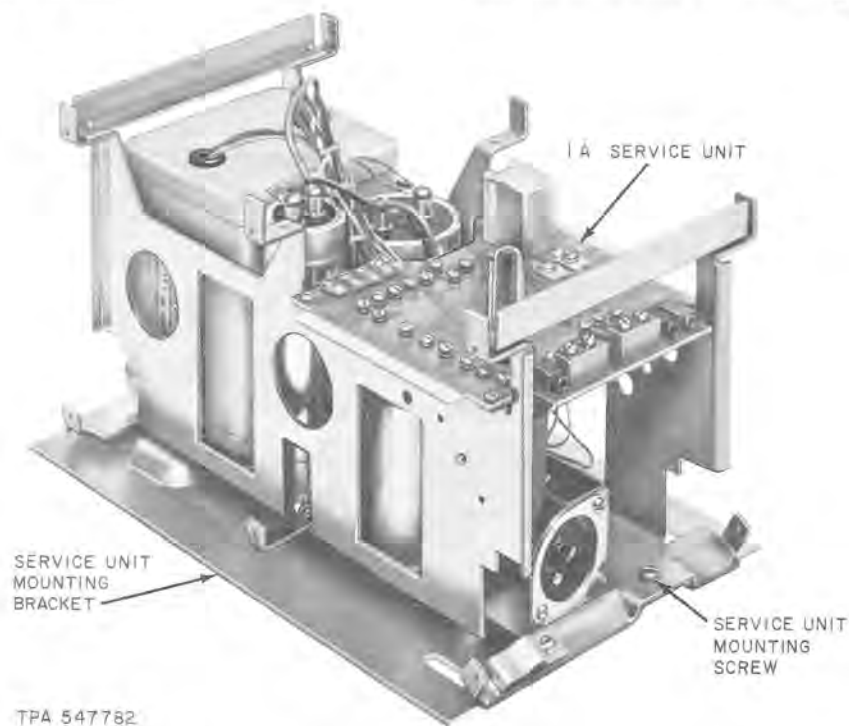

◆ Fig. 14—1A Service Unit and Mounting Bracket ◆

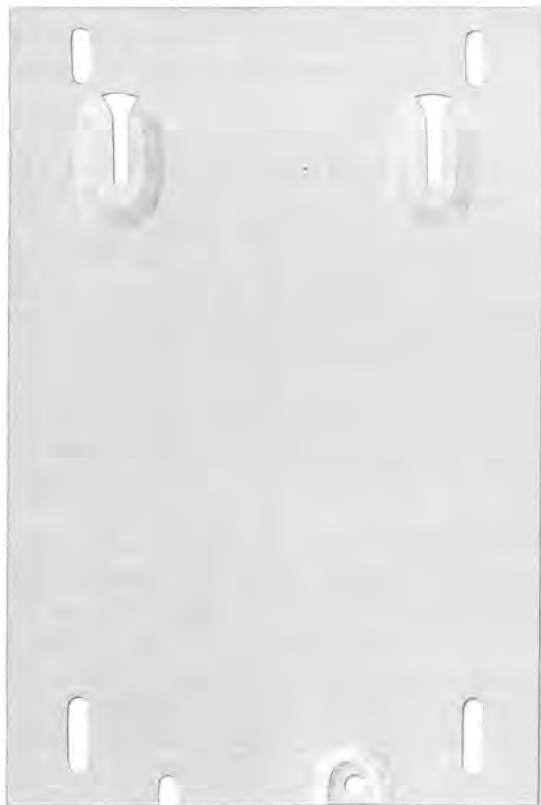

Fig. 15—1A Service Unit Mounting Bracket

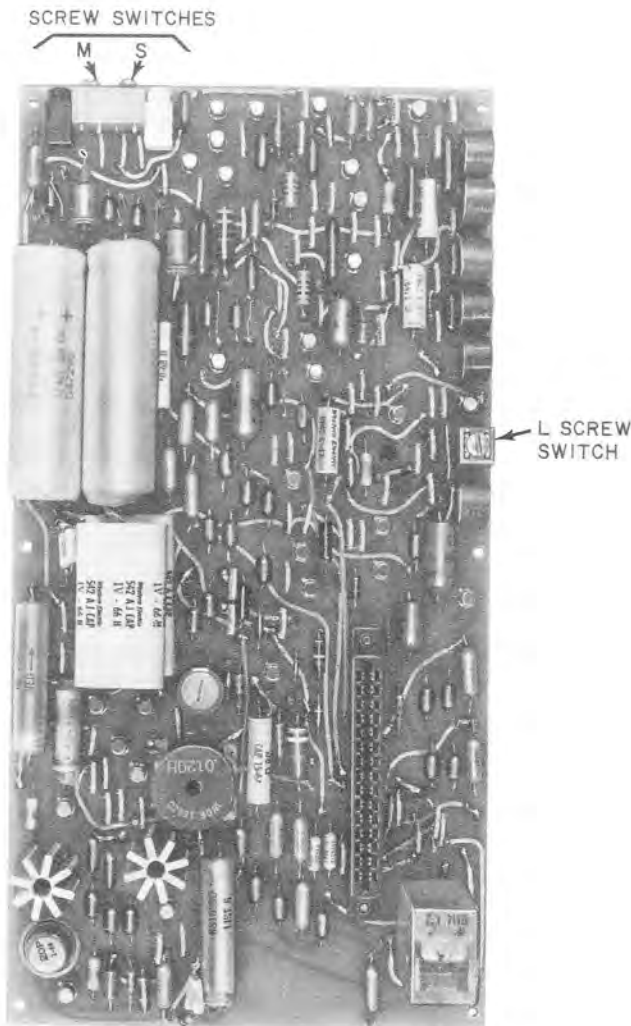

Fig. 16—939A Cable Equalizer

3.24 Plug power cord in power connector (Fig. 18). **Do not plug cord into ac receptacle at this time.**

3.25 Install 1A service unit on wall mounting bracket (see 3.15). Use care when placing or removing unit from mounting bracket as it is top heavy.

**55D Control Unit**



*The 55D control unit must be located within 100 feet of the 1A display unit.*

3.26 Mount 55D control unit vertically on wall (or suitable vertical surface) using appropriate fasteners. Refer to appropriate section in 080 Division for selection and installation of fasteners. The 55D control unit should be mounted in close proximity to the 1A service unit to facilitate wiring.

3.27 Obtain ac power from 1A service unit or from separately mounted 2012B transformer.

**D50AF Cord**

3.28 *To install cord in 1A display unit:*

- (1) Swivel top of display unit to approximate position shown in Fig. 1.

**Note:** GRAPHIC VISOR must be in closed position to prevent damage to visor.

- (2) Carefully tip display unit forward until it rests on its face and on front of ring, exposing bottom of pedestal (Fig. 19). Care should be taken to protect the surface of the furniture on which it rests.

- (3) Remove the two screws holding coverplate on bottom of ring and remove plate.



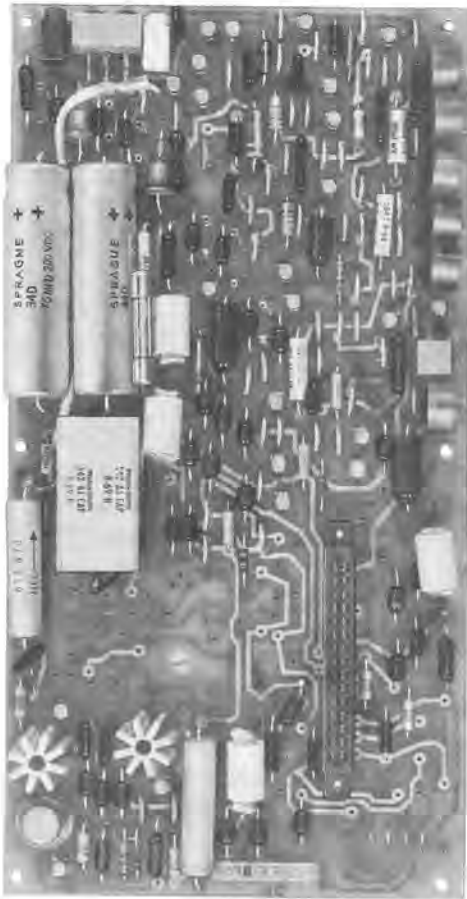

Fig. 17—939B Cable Equalizer

- (4) Gently pull plug from hollow pedestal until sufficient slack is obtained and connect cord to plug.
- (5) Push slack back into pedestal and replace coverplate and screws.
- (6) Make sure friction pads are in place and screws are tight to avoid damage to furniture.

### 3.29 To install cord in 72A control unit:

- (1) Loosen screws on bottom of control unit (Fig. 20) and remove housing and panel assembly.
- (2) Plug cord into connector on printed wiring board, replace housing and panel assembly, and tighten screws.

### 3.30 To install cord in 1A service unit:

**Caution:** On new installations, do not connect cord between 1A display unit and 1A service unit until service unit voltages have been checked as outlined in Section 518-800-501.

**Note:** Power is *not* applied to the cable equalizer in the 1A service unit until a display unit or a dummy plug is connected to the service unit. The CETS (cable equalizer test set) is supplied with an H-326-335-Group 9 dummy plug (cord assembly). This dummy plug is used when aligning station set cable equalizer 939A or 939B in a 1A service unit when *no* display unit is connected. The dummy plug is placed in the connector to which the display unit is normally attached, and turns on power to permit aligning the 939A or 939B equalizer.

- (1) Loosen screws and remove cover.
- (2) Plug cord into connector and replace cover.

### 1A Display Unit

#### 3.31 To install D50AF cord in display unit: See 3.28.

#### 3.32 To remove 1A display unit housing assembly:

**Caution:** Dangerous voltages appear in the 1A display unit. Disconnect power before removing housing. Do not attempt to operate 1A display unit while housing is off.

- (1) Swivel top of display unit to position shown in Fig. 1.
- (2) Open GRAPHIC VISOR and locate screw holding housing to unit (over the top of the visor at a 45-degree angle). Carefully insert proper size screwdriver and loosen captive screw.
- (3) Loosen the two screws located at the bottom front edge of the housing. (Fig. 19).
- (4) Slide housing to the rear and off the display unit.

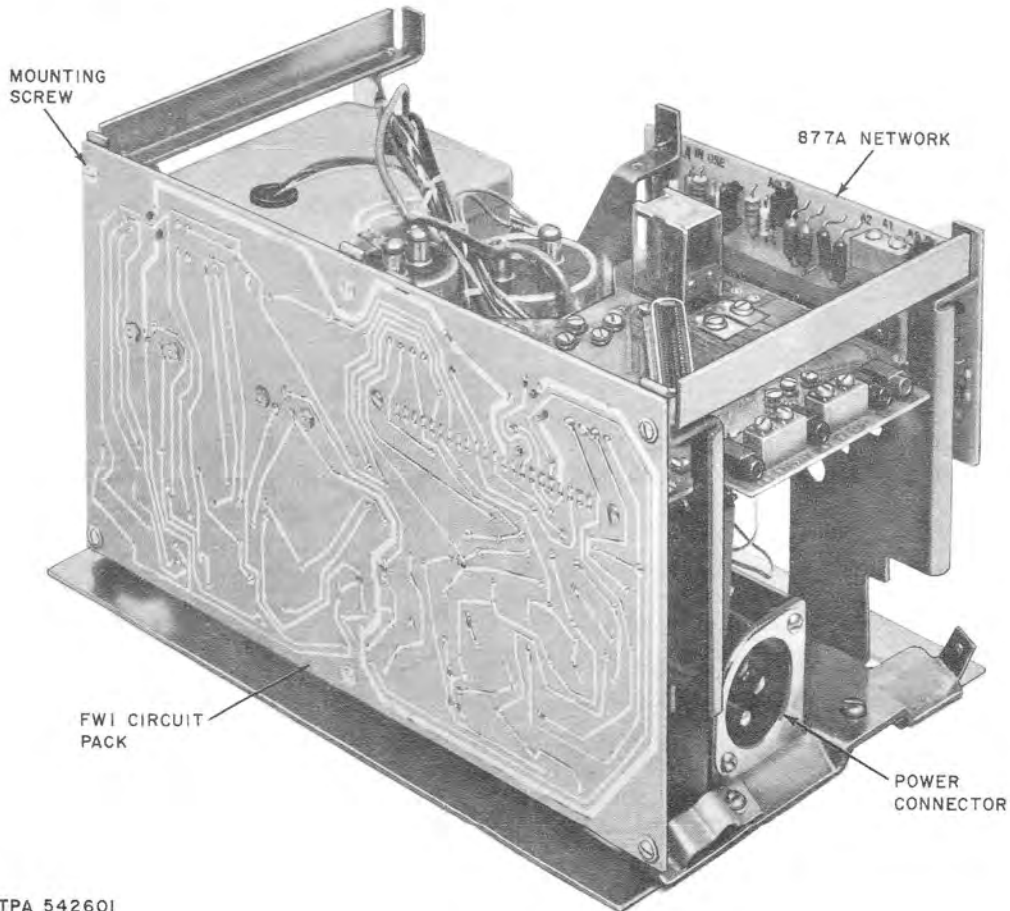
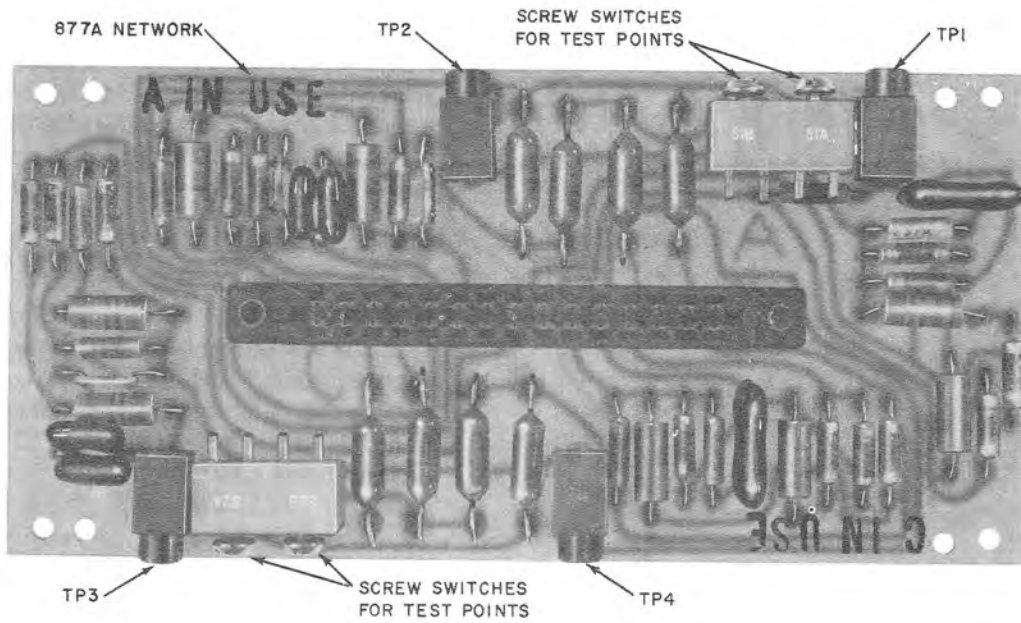

TPA 542601

Fig. 18—1A Service Unit With 877A Network

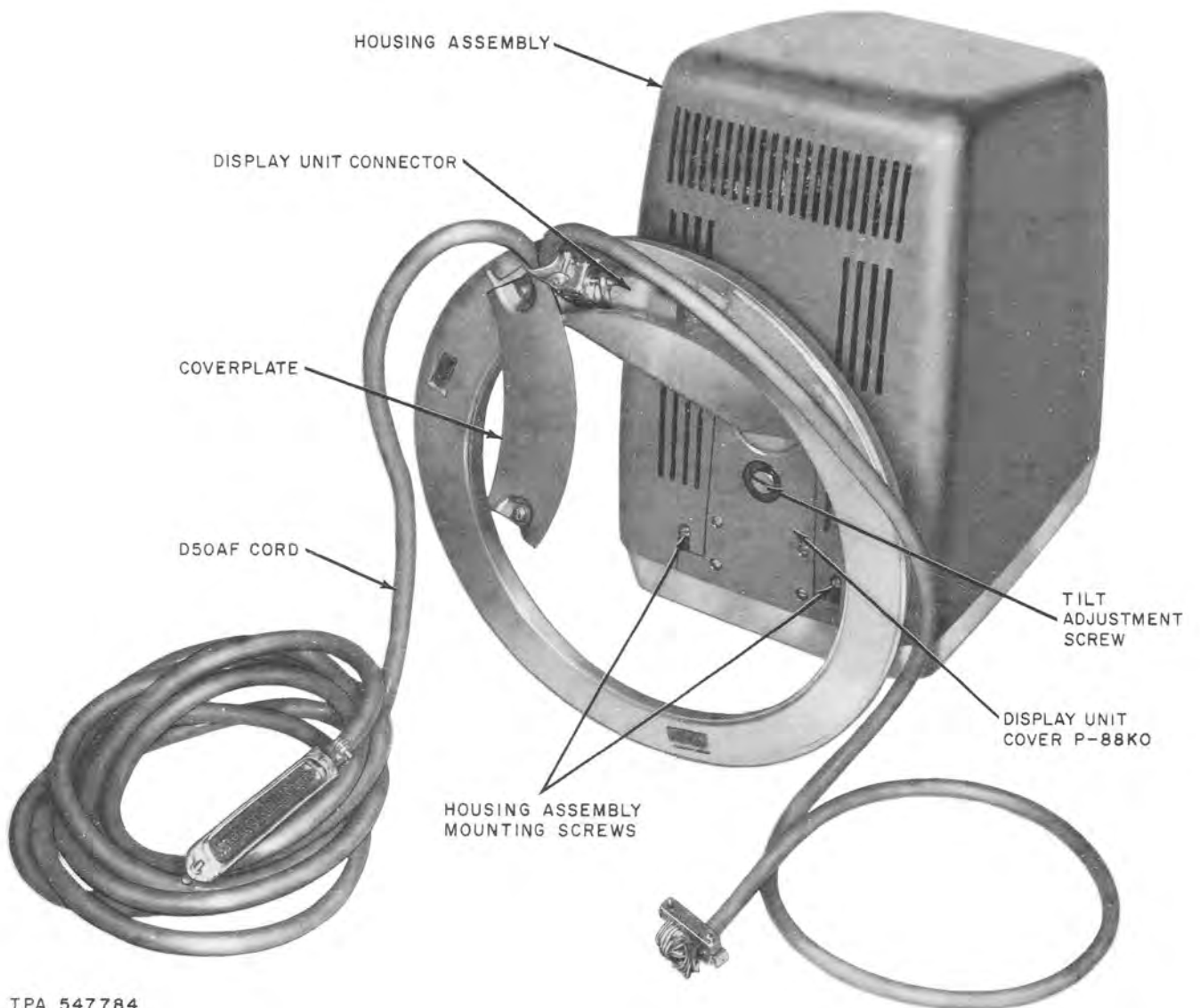

TPA 547784

◆ Fig. 19—Bottom View of 1A Display Unit ◆

(5) Reverse above procedures to replace housing.

**3.33 To remove display unit cover (Fig. 19):**

- (1) Remove the four screws holding the cover in place.
- (2) Remove cover.
- (3) Reverse the procedure to replace cover.

**3.34 To adjust tilt of display unit:**

- (1) Turn the adjustment screw (Fig. 19) in the desired direction.

**72A Control Unit**

**3.35 To install D50AF cord in control unit:**  
See 3.29.

**3.36 To replace control unit housing and panel assembly:**

- (1) Loosen screws on bottom of control unit (Fig. 20) and remove housing and panel assembly.
- (2) Place new housing and panel assembly on control unit and tighten screws.

**3.37 To replace lamp in control unit:**

- (1) Remove housing and panel assembly (3.36).
- (2) Replace lamp (Fig. 21).
- (3) Replace housing and panel assembly (3.36).

**Key Telephone Set**

**3.38** Install KS-20673, List 1 lamp(s) in key telephone sets on lines associated with PICTUREPHONE service. Refer to appropriate section in Division 512 for information on installing lamps.

*Note:* The KS-20673, List 1 lamp consists of two diodes and two lamps (one red and

one clear) housed in a plastic body. The red lamp lights to signify a PICTUREPHONE call and the clear lamp lights on an audio call. **To ensure that the lamp is installed correctly;** go off-hook (with the telephone set connected). If the clear lamp lights, the lamp is installed properly; if the clear lamp does not light, reverse the lamp in its socket and check again.

**3.39** Install a 400J or 446F or equivalent diode, if required for various service features. Refer to appropriate connection section for telephone set used and make modifications using "busy lamp" circuit.

**WIRING**

**3.40** Refer to Section 518-800-401 for connections for the 2C Video Telephone Station.

**TESTS**

**3.41** Installation test procedures, using the 136A test set, are outlined in Section 518-800-501.



**Before installation tests are made, video loop alignment procedures must have been completed as outlined in Section 518-800-510.**



**Fig. 20—Removing Housing and Panel Assembly From 72A Control Unit**

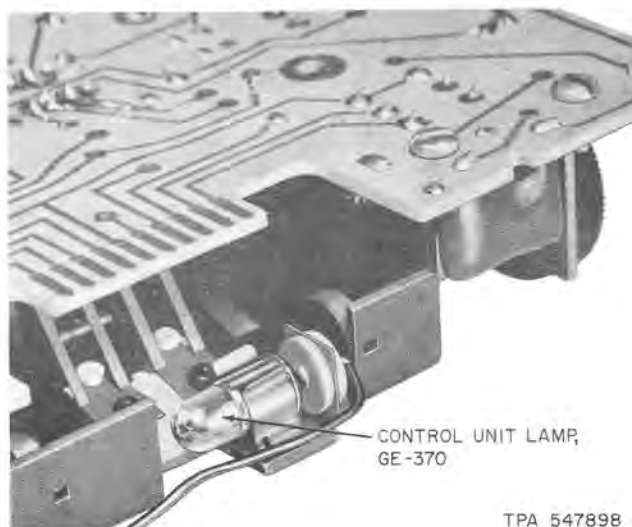

TPA 547898

**Fig. 21—72A Control Unit Lamp**